

Radio Electronics®

JULY 1991

TECHNOLOGY - VIDEO - STEREO - COMPUTERS - SERVICE

BUILD YOUR OWN EKG

Keep tabs on your heart with R-E's electrocardiograph!

BUILD A COLOR-BAR TEST GENERATOR

Test and troubleshoot your video equipment.

D/A and A/D CONVERTERS

A look at the chips that bring the digital and analog worlds together.

BUILD A LOGIC ANALYZER

A 16-channel, 50-MHz digital troubleshooting tool.

TEST IC's WITH YOUR PC

And learn about computer-based test equipment.

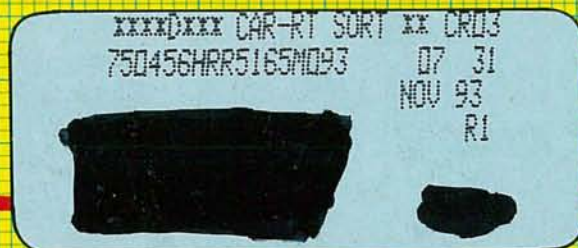
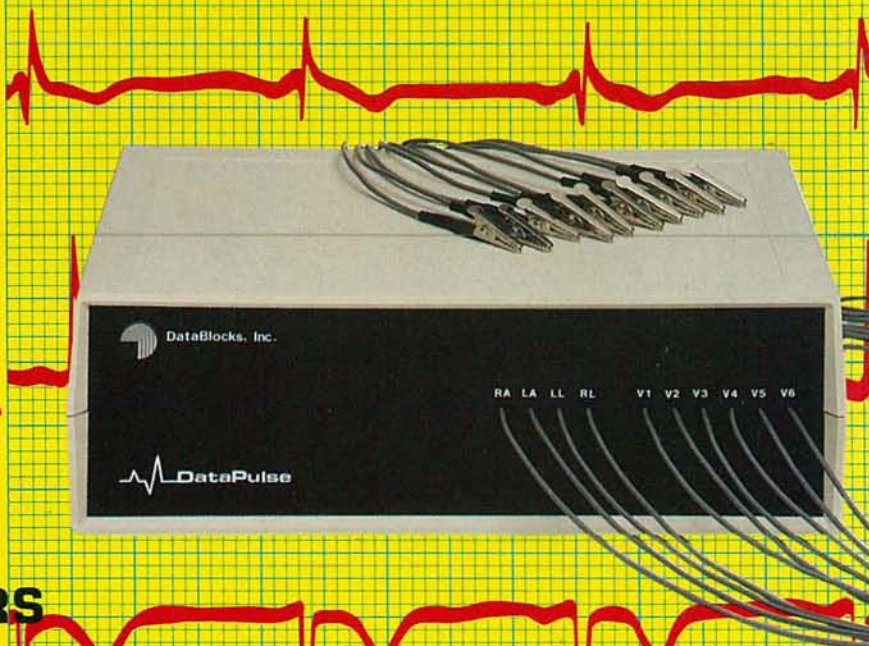

\$2.95 U.S.
\$3.75 CAN

A
GERNSBACK
PUBLICATION

FLUKE®



PHILIPS

9.0125 V DC 17.728 mV AC



Two displays. One great meter.

Dual displays provide two accurate measurements. Combined with 16 different measurement capabilities. The Fluke 45 is making people take a second look.

The Fluke 45 has the specs to get the job done right. 0.02% basic dc voltage accuracy and 100,000 count resolution on both displays. Basic dc current accuracy is 0.05%, making the 45 ideal for servicing 4-20 mA current loops. The Fluke 45 measures true-rms voltage and current, including ac+dc. Closed-case calibration simplifies the calibration process and increases uptime.

Twice as much information. The 5-digit, 100,000 count dual displays give you more information in less time—and with less effort. For example, measure the VDC output of a power supply while measuring the VAC ripple. Or check the amplitude and frequency of an AC signal. From a single test connection!

More measurement combinations.

With the Fluke 45 complex measurements become simple, with standard features like a 1 MHz frequency counter, Min Max, limits testing (Hi/Lo/Pass), Touch Hold® and Relative modes. There are 21 different reference impedances for dB measurements; in the 2Ω to 16Ω ranges, audio power can be automatically displayed in watts. The variety of electrical parameters, measurement functions and display combinations is incredible.

Even an RS-232 interface is standard.

Connecting the Fluke 45 to PCs, RS-232 printers and modems is as easy as attaching the cable. An IEEE-488.2 interface and internal, rechargeable lead-acid batteries are available as options.

Get a great value.

Contact your local distributor today for complete information on the new Fluke 45. Or call toll-free **1-800-44-FLUKE, ext 33.**

FLUKE 45 DUAL DISPLAY MULTIMETER

\$635*	dB, with 21 reference impedances, and audio power calculations
Dual Display	Compare and Relative functions
True-rms voltage and current, including ac+dc	Min Max and Touch Hold® functions
0.02% basic dc voltage accuracy	Optional PC software for RS-232 applications
0.05% basic dc current accuracy	Optional IEEE-488.2 interface, battery pack
1 MHz frequency counter	One year warranty
RS-232 interface standard	

*Suggested U.S. List Price

John Fluke Mfg. Co., Inc. P.O. Box 9090 M/S 250C Everett, WA 98206
U.S.: 206-356-5400 Canada: 416-890-7600 Other Countries:
206-356-5500 © Copyright 1989, 1990 John Fluke Mfg. Co., Inc.
All rights reserved. Ad no. 00015. IBM PC is a registered trademark of International Business Machines Corporation.

FROM THE WORLD LEADER
IN DIGITAL MULTIMETERS

CIRCLE 121 ON FREE INFORMATION CARD

FLUKE®

BUILD THIS

- 31 BUILD AN ELECTROCARDIOGRAPH**
Learn about medical electronics while monitoring your heart.
H. Edwards Roberts, M.D.
- 41 COLOR BAR GENERATOR**
Test and troubleshoot your video equipment.
Thomas Gould
- 47 LOGIC ANALYZER**
Check digital circuits with our 16-channel, 50-MHz logic analyzer.
Gerard Robidoux and Robert Dmitroca

COMPUTERS

- 53 EXPERIMENTING WITH PC-BASED TEST EQUIPMENT**
Build a PC-based IC tester for less than \$100!
James J. Barbarello

TECHNOLOGY

- 58 DIGITAL-TO-ANALOG AND ANALOG-TO-DIGITAL CONVERTERS**
An in-depth look at the chips that bridge the digital and analog worlds.
Stephen J. Bigelow

DEPARTMENTS

- | | |
|---|---|
| <ul style="list-style-type: none">6 VIDEO NEWS
What's new in this fast-changing field.
David Lachenbruch20 EQUIPMENT REPORTS
Fluke Model 79 DMM.65 HARDWARE HACKER
Understanding transformers, and more.
Don Lancaster | <ul style="list-style-type: none">72 AUDIO UPDATE
A distortion primer: Part 2.
Larry Klein80 COMPUTER CONNECTIONS
A new beginning for this column.
Jeff Holtzman |
|---|---|



PAGE 47



PAGE 41

AND MORE

- 94 Advertising and Sales Offices**
- 94 Advertising Index**
- 8 Ask R-E**
- 10 Letters**
- 84 Market Center**
- 29 New Lit**
- 22 New Products**
- 4 What's News**

ON THE COVER



If you've been having heart palpitations, see a doctor. But if you've simply been curious about medical electronics and like to keep tabs on your health, see our cover story, "Build an Electrocardiograph." Our EKG can't replace a cardiologist, but it can produce results that are virtually identical to those from commercial machines costing \$10,000 or more. You'll learn a lot about medical electronics while building and using the EKG, and you'll have early warning of potential heart problems. Using a PC, you can display test results on a monitor or print out a hard copy. It doesn't take years of study to learn how to detect problems such as high blood pressure and irregular heart beats—you can learn to interpret the test results yourself in a few hours. For all the details, turn to page 31.

COMING NEXT MONTH

THE AUGUST ISSUE GOES ON SALE JULY 2.

BUILD A SPECTRUM ANALYZER

Our PC-based analyzer operates from 0.1 ± 800 MHz and costs about \$300.

BUILD AN RS-232 TERMINAL/MONITOR

Based on the MC78HC705 microcontroller, this device can act as a dumb terminal or as a sophisticated serial bus analyzer.

AN INTUITIVE LOOK AT ELECTROMAGNETIC THEORY

We celebrate the 100th anniversary of Maxwell's "A Treatise on Electricity and Magnetism" with an in-depth look at the electric field.

BUILD AN EKG: PART II

Construction and operating details.

As a service to readers, RADIO-ELECTRONICS publishes available plans or information relating to newsworthy products, techniques and scientific and technological developments. Because of possible variances in the quality and condition of materials and workmanship used by readers, RADIO-ELECTRONICS disclaims any responsibility for the safe and proper functioning of reader-built projects based upon or from plans or information published in this magazine.

Since some of the equipment and circuitry described in RADIO-ELECTRONICS may relate to or be covered by U.S. patents, RADIO-ELECTRONICS disclaims any liability for the infringement of such patents by the making, using, or selling of any such equipment or circuitry, and suggests that anyone interested in such projects consult a patent attorney.

RADIO-ELECTRONICS, (ISSN 0033-7862) July 1991. Published monthly by Gernsback Publications, Inc., 500-B Bi-County Boulevard, Farmingdale, NY 11735 Second-Class Postage paid at Farmingdale, NY and additional mailing offices. Second-Class mail registration No. R125166280, authorized at Toronto, Canada. One-year subscription rate U.S.A. and possessions \$17.97. Canada \$25.65 (includes G.S.T. Canadian Goods and Services Tax Registration No. R125166280), all other countries \$26.97. All subscription orders payable in U.S.A. funds only, via international postal money order or check drawn on a U.S.A. bank. Single copies \$2.95. © 1991 by Gernsback Publications, Inc. All rights reserved. Printed in U.S.A.

POSTMASTER: Please send address changes to RADIO-ELECTRONICS, Subscription Dept., Box 55115, Boulder, CO 80321-5115.

A stamped self-addressed envelope must accompany all submitted manuscripts and/or artwork or photographs if their return is desired should they be rejected. We disclaim any responsibility for the loss or damage of manuscripts and/or artwork or photographs while in our possession or otherwise.

Radio Electronics®

Hugo Gernsback (1884-1967) founder

Larry Steckler, EHF, CET,
editor-in-chief and publisher

EDITORIAL DEPARTMENT

Brian C. Fenton, editor
Marc Spiwak, associate editor
Kim Dunleavy,
assistant technical editor
Teri Scaduto, assistant editor
Jeffrey K. Holtzman
computer editor
Robert Grossblatt, circuits editor
Larry Klein, audio editor
David Lachenbruch
contributing editor
Don Lancaster
contributing editor
Richard D. Fitch
contributing editor
Kathy Terenzi, editorial assistant

ART DEPARTMENT

Andre Duzant, art director
Injae Lee, illustrator
Russell C. Truelson, illustrator

PRODUCTION DEPARTMENT

Ruby M. Yee, production director
Janice Box,
editorial production
Karen S. Brown
advertising production
Marcella Amoroso
production assistant

CIRCULATION DEPARTMENT

Jacqueline P. Cheeseboro
circulation director
Wendy Alanko
circulation analyst
Theresa Lombardo
circulation assistant
Michele Torrillo, reprint bookstore

Typography by Mates Graphics
Cover photo by Diversified Photo
Services

Radio-Electronics is indexed in
Applied Science & Technology Index
and *Readers Guide to Periodical Literature*.

Microfilm & Microfiche editions are
available. Contact circulation depart-
ment for details.

Advertising Sales Offices listed on page 94.

Radio-Electronics Executive and
Administrative Offices
1-516-293-3000.
Subscriber Customer Service:
1-800-288-0652.
Order Entry for New Subscribers:
1-800-999-7139.

The
Audit
Bureau
of Circulation



FREE
Hands-On
Technology Seminar
1-800-426-2200 Ext. 579



Five ways to look at 100 MHz. Starting at \$2295!

Just check the choices in our line-up of five 100 MHz oscilloscopes:

- GPIB Programmability
- Hardcopy Documentation
- 100 MS/s Single-shot
- Automatic Measurements

Name your application, we'll provide the solution.

Tek gives you the perfect blend of modern analog real-time and digital technologies in 100 MHz oscilloscopes. Whether it's hardcopy output from a fully programmable real-time scope, automatic measurements specified to .001%, or 100 MHz, 100 MS/s single-shot performance, no one has the

choices Tek does. To see it all, call your Tek rep or 1-800-426-2200. The closer you look, the more you'll appreciate Tek.



One company measures up.
Tektronix
COMMITTED TO EXCELLENCE

CIRCLE 92 ON FREE INFORMATION CARD

WHAT'S NEWS

A review of the latest happenings in electronics.

Solid-state radioluminescent light sources

Radioluminescence—the emission of light stimulated by radioactive decay—is well known and widely used. Novel inorganic, organic, and hybrid radioluminescent (RL) light sources developed at Sandia National Laboratories (Albuquerque, NM) have a variety of possible applications in optical computing and photonics, as airport runway emergency lighting, or even as a long-term power source. To create the RL lights, tritium is chemically bound in a solid; the ingredients that create the light are dissolved or suspended on a molecular scale and within atomic distances of each other. All three types are solid-state (they contain no liquid or gases). The resultant light source is a "light stick" or "light cube"—a glowing piece of plastic or aerogel that requires no electrical power, can be made in various shapes and sizes, and can produce almost any color.

The inorganic sources provide the advantages of long lifetime without degradation and brightness. At about 10 times brighter than standard, gas-filled RL lights, the Sandia inorganic lights are a good candidate for a power source. The basic idea is to create a very bright light and then surround it with a photovoltaic (solar cell) light converter to make electricity. The result is a "glowing sugar cube" that requires only a few square centimeters of semiconductor converter material. Sandia researchers believe it will be possible to create a "20-plus years" power source that is considerably smaller than a long-life lithium battery.

The post-laser printer?

In a joint venture between Westinghouse Electric Corporation and Tokyo Electric Company, Ltd., the Edge Emitter light source will be marketed to printer manufacturers as an alternative to conventional laser-printer technology. Developed by scientists at Westinghouse's Science and Technology Center in Pittsburgh, the device is based on a patented

process that uses light emitted from the edge of a thin film of zinc sulfide—which is up to 100 times brighter than light coming from the face of the film. The Edge Emitter is smaller and lighter than its laser counterpart, and may offer higher speed, better resolution, and better gray-scale printing capability. Because it includes no scanning mirrors or other moving parts, the Edge Emitter light source is projected to have an operating life three to five times longer than that of traditional printer light sources.

The new company, to be known as Edge Emitter Technology, Inc., will have its manufacturing operation located in Fremont, CA.

IEEE survey results

According to a survey of selected members of The Institute of Electrical and Electronics Engineers, Inc. (IEEE), worldwide compatible HDTV and simultaneous translation of human speech from one language to another will become realities in just 20 years. The survey, conducted by The Gallup Organization (Princeton, NJ), was conducted using a sample of 150 IEEE members—50 each from industry, government, and academia. There is more than a 50% chance that worldwide, compatible HDTV will be

implemented by the year 2010, according to 70% of those surveyed. In the computer field, 58% of the IEEE respondents agreed that by the year 2010 a computer will provide simultaneous language translation.

More than 95% of the respondents agreed that "over the next 20 years, engineering and technology will have a positive effect on the global environment." The engineers were almost unanimous in supporting a more assertive role for themselves in ensuring the constructive application of technologies, with 94% agreeing that they should address the costs, benefits, and risks associated with their contributions for the benefit of legislators and the public.

The response to questions about practical applications of superconductivity in transportation and power was less optimistic, with only 40 percent of those in government and 28% of those in academia believing such applications would be possible by the year 2010. Electrical engineers were even more pessimistic about the near-term development of large-scale power generation using controlled hydrogen fusion. Only 13% of the IEEE respondents agreed that there is a greater than 50% chance that such advances will occur by 2010. **R-E**



FIRST U.S. LCD PRODUCTION PLANT. The first U.S.-based mass-production plant for high information, dot-matrix, liquid-crystal displays (LCD's) for large-scale commercial use is scheduled to open in Camas, WA, this December. The company will be a part of Sharp Microelectronics Technology (a subsidiary of Japan's Sharp Corporation), but will operate as a separate company under the name Sharp Flat Display Manufacturing Co. The facility, which will produce LCD panels for use in laptop and notebook computers and other business products, is expected to result in 250 new jobs by the end of 1993.

Why take chances in today's job market?

Graduate as a fully trained electronics professional.

To get ahead and stay ahead in today's economy, you need the electronics training CIE has been providing its 150,000-plus successful graduates with for nearly 60 years.

Meet the Electronics Specialists.

When you pick an electronics school, you're getting ready to invest time and money. And your whole future depends on the education you receive in return. That's why it makes so much sense to go with number one... with the specialists... with CIE!

There's no such thing as a bargain education.

If you talk to some of our graduates, and we recommend you do, chances are you'd find a lot of them shopped around for their training. Not for the lowest priced, but for the best training available. They pretty much knew what was available when they picked CIE as number one.

Because we're specialists we have to stay ahead.

At CIE we have a position of leadership to maintain. Here are just a few of the ways we hang onto it...

Programmed Learning.

That's exactly what happens with CIE's Auto-Programmed Lessons®. Each lesson uses famous "programmed learning" methods to teach you important electronics principles. You explore them, master them completely, before you start to apply them. You thoroughly understand each step before you go on to the next. You learn at your own pace.

And, beyond theory, some courses come fully equipped with electronics equipment to actually let you perform hundreds of hands-on experiments.

Experienced specialists work closely with you.

Even though you study at home, CIE's faculty and staff stand ready to assist via CIE's toll free number. And, each time you return a completed exam you can

be sure it will be reviewed, graded and returned with the appropriate instructional help, you get it fast and in writing from the faculty technical specialist best qualified to answer your question in terms you can understand.

Pick the pace that's right for you.

CIE understands people need to learn at their own pace. There's no pressure to keep up...no slow learners hold you back. If you're a beginner, you start with the basics. If you already know some electronics, you move ahead to your own level.

"Same Day" grading cycle.

When we receive your lesson, we grade it and mail it back the same day. You find out quickly how well you're doing!

State-of-the-art laboratory equipment.

Some courses feature the CIE Microprocessor

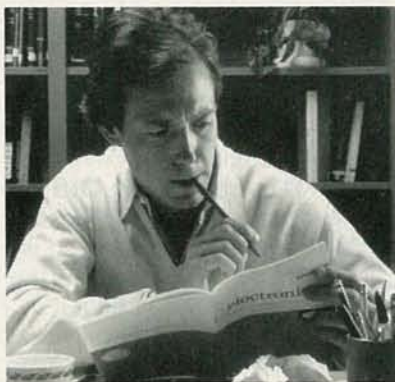

Training Laboratory. An integral part of computers, microprocessor technology is used in many phases of business, including service and manufacturing industries. The MTL gives you the opportunity to program it and interface it with LED displays, memory devices and switches. You'll gain all the experience

needed to work with state-of-the-art equipment of today and tomorrow.

New Courses!

CIE now offers two new career courses: Automotive Electronics and Computer Operation and Programming.

CIE offers you an Associate Degree.

One of the best credentials you can have in electronics — or any other career field — is a college degree. That's why CIE offers an Associate in Applied Science in Electronics Engineering Technology. And all CIE career courses earn credit toward your degree.

Which CIE training fits you?

Beginner? Intermediate? Advanced? CIE home study courses are designed for ambitious people at all entry levels. People who have: No previous electronics knowledge, but do have an interest in it; Some basic knowledge or experience in electronics; In-depth working experience or prior training in electronics.

At CIE you start where you fit and feel comfortable where you start, then go on from there to your Diploma, Associate Degree and career!

Today is the day. Send now.

Fill in and return the postage-paid card attached. If some ambitious person has already removed it, cut out and mail the coupon below. You'll get a FREE CIE school catalog, plus complete information on independent home study. Mail in the coupon below or, if you prefer, call toll-free 1-800-321-2155 (in Ohio, 1-800-623-9109).

YES! I want to get started. Send me my CIE school catalog including details about the Associate Degree program. (For your convenience, CIE will have a representative contact you — there is no obligation.)

Print Name _____

Address _____ Apt. _____

City _____ State _____ Zip _____

Age _____ Area Code/Phone No. (____) _____

Check box for G.I. Bulletin on Educational Benefits Veteran Active Duty

CIE CLEVELAND
INSTITUTE OF
ELECTRONICS, INC.
1776 East 17th Street • Cleveland, Ohio 44114 • (216) 781-9400



A school of thousands.
A class of one.
Since 1934.

AE17

VIDEO NEWS

What's new in the fast-changing video industry.

DAVID LACHENBRUCH

• **Multimedia hits the market.**

The first interactive multimedia system for consumers is now on the market. Starting in California in April, and now gradually scheduled to spread out across the rest of the United States, Europe, and Japan, is CDTV (which stands for Commodore Dynamic Total Video), a CD-ROM-based system derived from Commodore's versatile Amiga computer. Although CDTV doesn't yet provide full motion, it came to market at a \$999 suggested list price with a library of some 50 titles available, mainly between \$30 and \$80. CDTV plugs into the RF, video, or S-video input of the TV set, and a wireless remote control manipulates an on-screen cursor for viewer input. Among the available programs are an atlas, an encyclopedia, and a dictionary, plus games, children's stories, interactive mysteries, and "coloring books."

Later this year, CDTV is expected to have company in the form of Compact Disc-Interactive, or CD-I, developed largely by Philips but endorsed by Panasonic, Sony, and other Japanese manufacturers. Neither CD-I nor CDTV has full motion on-screen, and the two systems are mutually incompatible. However, Philips said that it will make available simple, plug-in full-motion adapters after standards are finalized, or sometime in 1992, and Commodore said that it will adopt full-motion video as well. Whether interactive multimedia is the next major consumer-electronics trend or if it turns out to be just another gadget looking for a use is still up to the market to determine.

• **Compressed cable.** Digital compression is the hot topic in the cable TV business these days, with a number of systems due to be tested on the consumer market soon. Cable TV Laboratories, supported by cable operators, has formed a digital-compression consortium with General Instrument and Scientific-Atlanta to speed the introduction of com-

pressed-signal systems. These systems will use compression to squeeze a number of programs onto a single channel, first for satellite delivery and later for delivery to private homes.

Meanwhile, a "non-compressed" 150-channel system is now being installed in Queens, NY, by Time Warner in the upgrading of a 75-channel system. The system will use fiber optics as a trunk carrier, and newly developed equipment to feed the 150 channels into standard coaxial cables that are already going into the area. Time Warner officials said the system will make it possible eventually to beam special programs to specific neighborhoods and even to individual homes.

With the use of digital compression, the same system will be able to carry 600 to 1200 channels, according to Time Warner. With such a system on the way, according to cable industry officials, the problem is no longer a technical one but a marketing issue—determining what kind of programs should be carried on the wealth of channels that will become available.

• **Still plus motion.** Although several manufacturers have introduced digital electronic snapshot cameras, they haven't gained widespread popularity, presumably because of high price and somewhat limited utility. Perhaps the answer to the problem is, as Hitachi believes, to combine the electronic still camera with the camcorder. As demonstrated at a recent technology exhibition in Tokyo, the Hitachi camera can make a standard analog 8mm videotape. However, it also has a "snapshot" button, which, when pressed, can record a still, high-definition, digital picture on the 8mm tape's audio track. The still snapshot may be made at the same time a videotape is being shot, at the rate of one snapshot every 12 seconds. In the prototype, six one-megabit DRAM's are used for digital still recording. While the conventional Hi8 analog tape recording has a band-

width of 500 kHz, the still picture recording made with the same camera has a bandwidth of 2 MHz. The still picture has resolution of 768 lines vertically and 512 horizontally, Hitachi says. The prototype camcorder used two 410,000-pixel CCD's. Hitachi says the digital still feature will add about \$150 to \$220 to the cost of a Hi8 camcorder, but it will eliminate the need for a separate still camera.

A simpler still-motion camcorder system is already on the market in Europe, where a Philips Super VHS camcorder is designed to make a full-frame analog still recording or a standard S-VHS moving tape at the option of the operator. You'll have to choose one format at a time; the two can't be made at the same time.

• **Old names for new.** Hey, you TV-nostalgia buffs—Admiral is back, and so is Crosley, but Majestic died again. The famous-name revival continues in TV brands. Although the Majestic brand was revived for a short time, that old devil recession did it in; products with that brand name have been suspended. However, Montgomery Ward paid some money to an appliance manufacturer and revived the brand name of Admiral, a pioneer once known for its cheap TV sets. "Monkey Ward" also plans to field a line of TV's under the Bell & Howell label—a name that sounds like it once was a high-end TV but never really was (it was applied to slide and movie projectors and audio tape recorders). Another old-timer, Crosley, is doing quite well as a private brand for smaller dealers. And, of course, there's Emerson, which in the last 10 years has made an impressive comeback, although it's not related to the original Emerson Radio, which pioneered table model radios and smaller TV's. In fact, none of these brands are related to their original ancestor. But then, RCA and GE, as well as Magnavox, Sylvania, and Philco, are now made by new owners, although they do happen to have some direct lineage from TV's pioneering days.

R-E

SELECT 5 BOOKS for only \$4.95

(values to \$102.75)

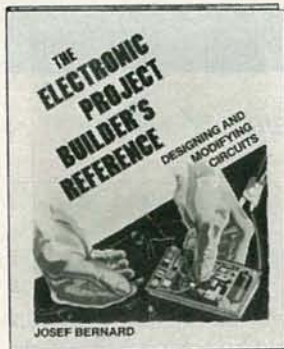
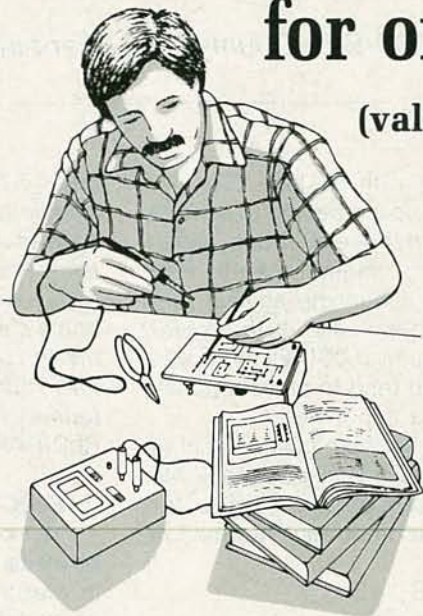

3260 \$22.95



9290 \$36.00
Counts as 2



3321P \$16.95



2826P \$16.95



3279 \$36.95
Counts as 2



3031P \$17.95



2980P \$19.95



3267P \$16.95



3342 \$25.95
Counts as 2



3374P \$16.95



2707P \$17.95



2800P \$16.95



2613P \$17.95



3329 \$29.95
Counts as 2



2867P \$18.95



2987P \$16.95



2925P \$9.95

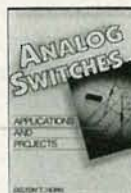

3445 \$21.95



2995 \$25.95
Counts as 2

Your most complete source for electronics books for over 25 years.



3414 \$39.95
Counts as 2



3107P \$18.95



2865P \$14.95



3138 \$60.00
Counts as 3

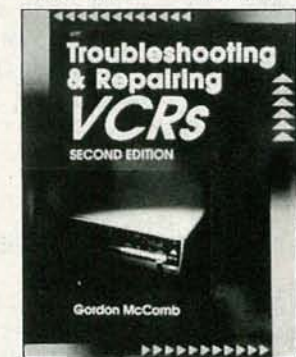

3777 \$32.95
Counts as 2

Membership Benefits • Big Savings. In addition to this introductory offer, you keep saving substantially with members' prices of up to 50% off the publishers' prices. • **Bonus Books.** Starting immediately, you will be eligible for our Bonus Book Plan, with savings of up to 80% off publishers' prices. • **Club News Bulletins.** 15 times per year you will receive the Book Club News, describing all the current selections—mains, alternates, extras—plus bonus offers and special sales, with scores of titles to choose from. • **Automatic Order.** If you want the Main Selection, do nothing and it will be sent to you automatically. If you prefer another selection, or no book at all, simply indicate your choice on the reply form provided. You will have at least 10 days to decide. As a member, you agree to purchase at least 3 books within the next 12 months and may resign at any time thereafter. • **Ironclad No-Risk Guarantee.** If not satisfied with your books, return them within 10 days without obligation! • **Exceptional Quality.** All books are quality publishers' editions especially selected by our Editorial Board.

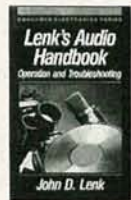

10076 \$39.95
Counts as 2



3275 \$22.95



3270 \$32.95
Counts as 2

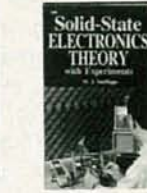

2926 \$25.95
Counts as 2



3343 \$29.95
Counts as 2



3475 \$27.95
Counts as 2

ELECTRONICS BOOK CLUB

Blue Ridge Summit, PA 17294-0810

Please accept my membership in the Electronics Book Club and send the 5 volumes listed below, billing me \$4.95. If not satisfied, I may return the books within ten days without obligation and have my membership cancelled. I agree to purchase at least 3 books at regular Club prices during the next 12 months and may resign any time thereafter. A shipping/handling charge and sales tax will be added to all orders.

Name _____

Address _____

City _____

State _____ Zip _____ Phone _____

Valid for new members only. Foreign applicants will receive special ordering instructions. Canada must remit in U.S. currency. This order subject to acceptance by the Electronics Book Club. RPIE791

All books are hardcover unless number is followed by a "P" for paperback.

(Publishers' Prices Shown)
©1991 ELECTRONICS BOOK CLUB

LETTERS

Write to Letters, Radio-Electronics, 500-B Bi-County Blvd., Farmingdale, NY 11735

AUDIOPHILE ATTITUDES

My thanks to **Radio-Electronics**, and especially to Larry Klein, for his excellent series of articles about audiophile attitudes and equipment. His well-reasoned and fully documented data are long overdue.

The level of foolishness in the consumer-audio and audiophile markets should be an embarrassment to all professionals in the electronics field. Beliefs in things ranging from absurd speaker cables to "greening" of CD's are no more legitimate than Creation Science, and the audio faithful who are willing to part with \$10,000 or more for an antiquated tube amplifier must surely qualify as the all-time champions of gullibility. Thanks again.

PAUL J. CARLSON
Pittsburgh, PA

MAGNETIC FIELD METER QUERIES

I really enjoyed Reinhard Metz's article, "Build this Magnetic Field Meter" (**Radio-Electronics**, April 1991). I thought the issues of possible health risks, magnetic field theory, and the pictures of sources of magnetic-field exposure were presented very well.

For the last year I have been involved in evaluating problems concerning ELF magnetic fields and remedial solutions. Part of my work was directed to evaluating Gauss meters and magnetic-field measurement systems.

I have three questions about the meter. First, I wonder if the unshielded coil on the PC board might be sensitive to the electric as well as the magnetic fields, and because of the differing vectors, give ambiguous readings? Second, the article stated that the meter is usable in a frequency range from 50 Hz to 20 kHz. Is the meter reasonably flat with frequency over its entire dynamic range? I know that this can be a serious problem and can lead to substantial errors in measurement. Third, I worry that the relative insensitivity (0.1 μ F) of this

meter, along with its high (20 mT) range, might cause people to expose themselves to those 10–20 mT fields while making measurements. Perhaps a note cautioning against that would have been wise. If the meter range had been 0.001–20 μ T, over-ranging would tend to prevent possibly hazardous exposure.

I hope I'm not being overcritical of the meter. Again, I'd like to thank Mr. Metz and **Radio-Electronics** for presenting this important information to the public.

JOHN MILLS
Ben Lomond, CA

Thank you for your kind comments about my article. In response to your questions: First, while the magnetic field pickup coil might be considered an antenna for the electric fields, its small size would make it efficient as such only at relatively high frequencies, where the op-amps are ineffective. At lower frequencies, the electric field pickup appears primarily as common-mode voltage, and should not get amplified. Tests of the unit have been successfully conducted in RF fields up to 20 volts/meter.

Second, in regard to frequency range and flatness of response, while it was stated that the response was from 50 Hz to 20 kHz, it was in fact optimized for power-line frequencies and their third harmonics. If you are interested in optimal flatness to 20 kHz, I would suggest changing the following component values: R3 becomes 16K and R12 becomes 80 ohms (or C7 becomes 800 pF).

Finally, I'm not sure how the 20-mT range of the meter would "cause" a person to expose themselves to

fields in that range, unless they deliberately set out to create them for the sake of a meter deflection. That certainly would not be advised. However, to the extent that they may exist in some places and are detected by the meter, I agree that people should use that information to avoid further potentially hazardous exposure.

REINHARD METZ

ELECTRONICS BEHIND BARS

I'd like to thank **Radio-Electronics** for keeping alive my interest in electronics for the last eleven years. Without your magazine, I would not have been able to keep abreast of the massive changes in the industry. You see, I am a prisoner serving 15 years for committing a crime of passion. Since I entered prison in 1980, I have relied on your magazine to keep me informed of the changes. Had I not received a monthly issue, I would find myself upon release to be totally out of touch. All this time, without so much as seeing a soldering iron, your magazine has helped me to keep the faith.

In two years, I will be returning to a new life. Before leaving here, I hope to impart an enthusiasm for electronics to other prisoners. For five years, I have struggled to establish an electronics hobby club. Last week I was given permission. Most of the people I met in prison have not had the advantages I've had in my life. I know in my heart that fostering an interest in electronics and giving some of the other prisoners the basics of electronics will lead to a confidence in their abilities that will aid in reformation.

I'm asking for help from any of your readers who might have old copies of **Radio-Electronics**, **Popular Electronics**, **Hands-on Electronics**, or other electronic publications to send them to me. We'd also appreciate any plans or projects that they'd like to share, as well as old books, specification sheets, or helpful hints. Perhaps the most important thing I hope your readers can send is support—support in the form of let-

CORRECTIONS

There was a slight error in the circuit that was sent in to us from Johnny Bruyns of Port Shepstone, South Africa (Letters, January 1991). There should be a 4.7K resistor between the +V supply line and pin 7 of IC2. The direct connection that was shown should be replaced by the 4.7K resistor.

ters to club members. If anyone can write a letter a month to answer some basic electronics questions from prisoners, please contact me. Thank you.
ED MOORE
*c/o Chapel
 Kingston Penitentiary
 Kingston, Ontario
 Canada, K7L 4V7*

IN FAVOR OF AMIGA

Congratulations, Mr. Holtzman. You really had me going there, with your reply to Mr. Cheng in the April issue of **Radio-Electronics**. "Why doesn't Commodore build a low-cost MS-DOS multimedia machine." Don't be ridiculous! Perhaps if I'd received my issue on April 1, instead of in mid-March, I would have caught on sooner.

Unfortunately, I believe that some of Mr. Holtzman's other statements and observations are sincere. He claims that the Amiga has had little influence on the personal-computer industry. How does he define "influence?" By counting sheer numbers, or by cloning to the point of becoming a commodity? I hope not; that is a very uninteresting way of looking at things. If he hasn't already noticed, personal computers (PC's and Macs alike) are becoming more "Amiga-like" (multitasking, GUI's, coprocessors, a multitude of colors, etc.). That sure looks like influence to me!

Perhaps his view of the personal computer industry is just narrow and biased. I admit, the Amiga has broken no ground in the big three of applications: word processing, spreadsheets, and databases. However, if you consider the growing market for personal-computer graphics, the Amiga is a technological leader. I can't begin to list all the paint programs, 3-D modelling, rendering, and animation applications that exist for the Amiga. The simple fact is that what is considered "state of the art" in MS-DOS graphics software is rather crude by Amiga standards.

I believe that Mr. Holtzman is "not anti-Amiga." Unfortunately, he is far worse—he is indifferent. **Radio-Electronics** and the majority of other "general interest" magazines continue to ignore the Amiga and help perpetuate the myth that it is not a "serious computer."

Finally, I do have to agree with Mr. Holtzman concerning things like data

interchange standards. We in the Amiga community are blessed with the IFF data standards; I wish it was just as easy to work across other platforms.

I, like millions of others, prefer being on the leading edge of personal-computer technology. In your zeal for standards, please don't expect everyone to descend to the level of IBM/MS-DOS. *There is more than one way to process bits!*
TOM HUTCHINSON
Pilot Rock, OR

APRIL SPIRIT

I loved your "Poor Man's Laser Printer" article (**Radio-Electronics**, April 1991). Let me tell you, the idea was *great!*

I have attached a Panasonic 1991 Multisynch color monitor to a Panasonic FP-C1XE Digital Color Copier using your method. The results in Super VGA were, to say the least, incredible!

Two things are troubling me though. One is the dither moire I am getting, and the other is the cost: \$20,000 is a lot for color printing.
JESS KIDDING
Tonguen Cheek, NJ

Be an FCC LICENSED ELECTRONIC TECHNICIAN!



Earn up to \$30 an hour and more!

Learn at home in spare time. No previous experience needed!

No costly school. No commuting to class. The Original Home-Study course prepares you for the "FCC Commercial Radio-telephone License." This valuable license is your professional "ticket" to thousands of exciting jobs in Communications, Radio-TV, Microwave, Maritime, Radar, Avionics and more...even start your own business! You don't need a college degree to qualify, but you do need an FCC License.

No Need to Quit Your Job or Go To School This proven course is easy, fast and low cost! **GUARANTEED PASS**—You get your FCC License or money refunded. **Send for FREE facts now. MAIL COUPON TODAY!**

COMMAND PRODUCTIONS
 FCC LICENSE TRAINING, Dept. 90
 P.O. Box 2824, San Francisco, CA 94126
 Please rush **FREE** details immediately!

NAME _____
 ADDRESS _____
 CITY _____ STATE _____ ZIP _____

It's no fluke.



Made in the U.S.A.

Building the best DMM for the money is no accident. The new RMS225 was carefully designed to give you what you wanted at a price you could afford. Visit your local distributor today and you'll agree the choice is obvious.

Fluke Model 77	Beckman Industrial RMS225
3-1/2 Digits	4 Digits
3,200 Counts	10,000 Counts
0.3% Accuracy	0.25% Accuracy
Touch Hold®	Probe Hold™
31 Segment Analog Bar Graph	41 Segment Analog Bar Graph
2,000 Hour Battery Life	1,000 Hour Battery Life
10A Range (Fused)	10A Range (Fused)
Protective Holster	Protective Holster
3 Yr. Warranty	3 Yr. Warranty
—	True RMS
—	Auto Min Max™
—	Relative Mode
\$165*	\$149

® Touch Hold is a registered trademark of the John Fluke Mfg. Co., Inc.
 *1991 Fluke and Phillips U.S. Price List. JN190-01-0791

Beckman Industrial™
 An Affiliate of Emerson Electric Co.

Instrumentation Products Division
 3883 Ruffin Road, San Diego, CA 92123-1898
 (619) 495-3200 • FAX (619) 268-0172 • TLX 249031
 Outside California 1-800-854-2708 Within California 1-800-227-9781
 © 1990 Beckman Industrial Corporation. Specifications subject to change without notice. Fluke is a registered trademark of John Fluke Mfg. Co., Inc.

CIRCLE 98 ON FREE INFORMATION CARD

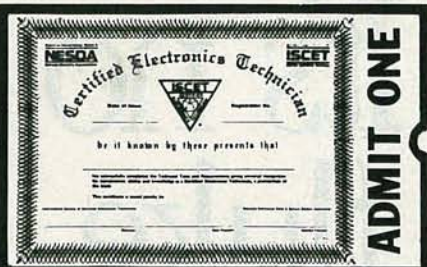

Your Ticket To SUCCESS

Over 28,000 technicians have gained admittance worldwide as certified professionals. Let your ticket start opening doors for you.

ISCET offers Journeyman certification in Consumer Electronics, Industrial, Medical, Communications, Radar, Computer and Video. For more information, contact the International Society of Certified Electronics Technicians, 2708 West Berry Street, Fort Worth, TX 76109; (817) 921-9101.

Name _____
Address _____
City _____
State _____ Zip _____

Send material about ISCET and becoming certified.

Send one "Study Guide for the Associate Level CET Test." Enclosed is \$10 (inc. postage).

FCC NO-CODE AMATEUR RADIO LICENSE

The FCC recently passed Docket 90-55 which for the first time allows a new codeless entry ham radio license of technician grade. Privileges 30 MHz and above — All modes! (See R.E. article in April 1991 issue).

Get all the no-code license details, study & testing information plus a one-year subscription to one of ham radio's longest running specialty mode publications that will teach you all about the new modes you will be able to operate!

FSTV SSTV FAX RTTY PACKET
AMTOR OSCAR FM REPEATERS
MICROWAVE AND LOTS MORE!

SEND
\$25
CHECK
OR
MONEY
ORDER



OUR
24TH
YEAR
SINCE
1967!

The SPEC-COM Journal
P.O. Box 1002,
Dubuque, IA 52004
(319) 557-8791



MC/VISA (5% added)



COMPUTER CLASHES CONTINUED

I really do think that Mr. Cheng's comments in the April "Letters" column went a bit far—and so did Mr. Holtzman's reply. The entire exchange brings to mind the old tale about the blind man and the elephant; it really is tough to discern the big picture through all the fog. As one who has programmed extensively for 80X86 PC's, Amigas, and other computers, I have more comments than I can fit in a reasonably sized letter. A few will have to do.

First, on standardization: As Mr. Holtzman pointed out, the desirable part about standardization is that it facilitates communication. There are two flip sides. One is that many software (as well as hardware) suppliers don't want communication. Suppliers of programs for CAD and music scoring are especially notorious—they want you locked in tight. The second is that standards are often ages out of date—witness the NTSC television standard—to the point of stifling innovation.

The niche machines are a paradox. They owe their existence to the fact that in one important sense they are *more* standardized than PC's. No two PC's are alike, even in such fundamentals as memory organization, video graphics layout, and interrupt organization. As we all know, that causes no end of problems. Within the CPU itself, the instruction set is an unstandardized chaos, having on the order of a thousand individual quirks. Even the largest, best-capitalized organizations have been able to cope with that, so that compiled code tends to be a wretchedly sub-optimal joke. The lessons of the old mainframes have yet to be learned.

The upshot is that things that aren't done often enough to support multi-billion-dollar software companies are often best done on niche machines, especially if speed, large memory, or a GUI is desired, or interrupts are needed. Sure, a Lotus or a Microsoft can handle the problems caused by dozens of graphics drivers, dozens of extended memory drivers, more than 500 printer drivers, dozens of slightly different serial and parallel ports, hundreds of quirky BIOS variants, and hundreds or maybe thousands of hard-disk variants. The person who writes a specialized program for filter analysis and sells a few hundred copies probably can't make it multi-com-

patible, except by resorting to lowest-common-denominator user interfaces and sticking by a 640K memory model. Even then, it's never really certain that the program that runs on my PC will run on the PC next door—and getting it to print properly on the system next door is well nigh out of the question.

So, what will become of those 60 million PC's, plus the Macs, Amigas, Ataris, and so on? It's sad, but humanity has been down this road before, and we find that horse carts, though they were once as abundant proportionally, simply aren't permitted on the freeway. Those computers aren't going to make it either, though some, notably the DOS PC, may well hang on for a long while as windows in some POSIX-OS/2-Windows-DOS-Sparc-Mac-PC-Amiga machine of the future. (After all, if it were worth the trouble, it wouldn't be all that hard to *simulate* an Apple or Commodore 64 of seven years ago on a 486 PC, high-end Mac, or high-end Amiga—*faster than real time!*)

And that raises what should be the hottest issue of all, something far more important than ranting and raving over doomed PC's versus doomed Macs versus doomed Amigas. The issue is our own data, which we must somehow get out of that DOS window and onto that machine of the future—to say nothing of moving it from one application to another or to a supercomputer. We have allowed much of our data, entered laboriously and at tremendous expense, to become embodied in files that are formatted in obtuse, secret, and unstandardized ways.

It is high time that the software manufacturers who practice this are forced to change. They are in effect thieves who have stolen from us what is rightfully our property. It is time to insist that all software that we buy have the capability to disgorge our data in full, including such things as the coordinates of graphical objects, in an open, published-data-interchange format. As a symbolic discouragement to theft and extortion by software manufacturers, and to allow third parties to assist in retrieving the stolen property without fear of litigation, it is time to amend the copyright law to explicitly permit reverse engineering in any program that stores output but won't provide it in an open format, irrespective of any

and all language to the contrary in the licensing "agreement."

We have been down this road before. Compiler suppliers once swore that royalty-free function libraries would end the world. Much the same was said of ANSI-standard C, and of spreadsheet DIF files, and so on. Oddly enough, the world is still here. So to any manufacturer who feels this proposal is unreasonable, I say this: Maybe your problem is that you are making money by holding your customers up for ransom, rather than by providing a good product. If so, the sooner you are out of business, the better—preferably on terms that are as punitive as possible to you, your investors, and your bankers. You are not indispensable, regardless of who you think you are or how big you are. There are hungry hordes waiting in the wings, ready, willing, and eager to replace you in a twinkling.

PAUL SCHICK
Madison, WI

Regarding Ms. Abbot's letter and Larry Klein's response in the October issue, as an audio/video repair technician who has attended mandatory factory-service seminars and who subscribes to several electronic magazines, I must agree with Ms. Abbot. Although service centers in my area charge a lower price for cleaning, they use head-cleaning tapes at that low price. For a more thorough, proper cleaning, they charge more.

A **Radio-Electronics** article entitled "Keep Your VCR Healthy" (March 1989) also supports Ms. Abbot's view and states, "We definitely do not recommend the use of any type of video-head cleaning cassette. It has been found that some of the cassette-type cleaners are actually

abrasive to the video heads."

While attending service seminars sponsored by Panasonic, RCA, and Samsung, the instructors stated that those companies void any warranties if head-cleaning cassettes have been used. The representative from Samsung mentioned the ability to use a high-grade tape with its built-in "chemical" cleaning (but not necessarily the recording part, just play it through).

I, too, have found the older mechanical VCR's to be more durable. The user can "punch" the keys and the machines can handle it, where the plastic inlays of the newer ones would snap apart and break. The newer electronic units also appear to be more susceptible to lightning strikes, power surges, and static discharge while just turning them on.

Mr. Klein has presented a lot of good ideas and covered some interesting subjects in his column, and I won't stop reading him because of his reply to Ms. Abbot. Thanks for the opportunity to express my opinion and experiences.

DAVE LEE
Anoka, MN

FREE CATALOG

Call (800) 992-9943

Over 35,000
Electronic Components

Call Today for Your
FREE SUBSCRIPTION

If You Order Today,
WE SHIP TODAY!!



(800) 992-9943

Stocking Locations Across America.

CIRCLE 117 ON FREE INFORMATION CARD

DAMARK

The "Great Deal" Catalog!

SCOTT By Emerson

286 AT COMPATIBLE COMPUTER
WITH 40MB HARD DRIVE AND 14"
VGA COLOR MONITOR



Emerson, one of the biggest names in the business is closing out these Scott 286 AT Computers so our buyer was able to purchase the remaining quantities for an unbelievably low liquidation price!

- 80286 microprocessor running at 12/6MHz. (switchable).
- 40MB IDE hard drive.
- One MB RAM on motherboard.
- One 3.5" 1.44MB floppy drive.
- One 5-1/4" 1.2MB floppy drive.
- IBM compatible.
- Slot for 80287 math co-processor.
- 5-16 bit full length expansion slots.
- Two serial ports, one parallel port.
- VGA multi-port video controller.
- 14" VGA, non-glare monitor, .41 dot pitch.
- Resolution: 640 x 480. • 101-key keyboard.
- Software includes: MS DOS 3.31 in ROM, Turbo Pascal 5.0, Menu Program Manager, Lotus and Quattro spreadsheet & PFS Professional Write word processing.
- Model #: 2000SC12F.
- One Year Limited Mfr. Warranty!
- Factory New!

Mfr. Sugg. Retail: \$2,998.00

DAMARK \$999.99
PRICE:

Item No. B-2634-168631 S/H \$49.00

FOR FASTEST SERVICE, CALL TOLL
FREE

1-800-729-9000



DAMARK INTERNATIONAL, INC.
7101 Winnetka Ave. N., Minneapolis, MN 55428-1619

DAMARK Customer Service:
1-800-733-9070

Please rush me: _____ Scott 286 AT Computer(s)
@ \$999.99 each, plus \$49.00 s/h each.
Item No. B-2634-168631
MN res. add 6% sales tax.

Name _____

Address _____

City, State, Zip _____

Check/MO VISA MasterCard Discover

Card No. _____

Ex. Date _____ Ph.# () _____

Signature _____

Copyright 1991 DAMARK International, Inc. All rights reserved.

DELIVERY TO 48 U.S. STATES ONLY

"Plant a tree today
for all the world to share"

You can make life better for your children and for the future. Join me and plant a tree today for all the world to share.

For your free brochure, write:
Trees for America, The National Arbor Day Foundation, Nebraska City, NE 68410.



John Denver for
The National Arbor Day Foundation

JULY 1991

No other training—anywhere—shows you service computers

Only NRI walks you through the step-by-step assembly of a powerful AT-compatible computer system you keep—giving you the hands-on experience you need to work with, troubleshoot, and service all of today's most widely used computer systems. With NRI at-home training, you get everything you need to start a money-making career, even a computer service business of your own.

No doubt about it. The best way to learn to service computers is to actually *build* a state-of-the-art computer from the keyboard on up. And that's just what you do when you train with NRI. As you perform key tests and demonstrations at each stage of assembly, you see for yourself how each part of your computer works, what can go wrong, and how you can fix it.

Only NRI, the leader in career-building electronics training for more than 75 years, gives you such practical, real-world computer servicing experience. Indeed, no other training—in school, on the job, *anywhere*—shows you how to troubleshoot and service computers like NRI.

You get in-demand computer skills as you train with a powerful AT-compatible computer system—now with 1 meg RAM and 20 meg hard drive

With NRI's exclusive hands-on training, you actually build and keep the powerful new AT-compatible West Coast 1010ES computer, complete with 1 meg RAM and 20 meg hard disk drive.

You start by assembling and testing the "intelligent" keyboard,

Now includes AT-compatible, 20 meg hard drive, and exciting new diagnostic package!

move on to test the circuitry on the main logic board, install the power supply and 5-1/4" high-density floppy drive, then interface your high-resolution monitor. But that's not all.

Your NRI hands-on training continues as you install a powerful 20 megabyte hard disk drive—today's most-wanted computer peripheral—included in your course to dramatically increase your computer's data storage capacity while giving you lightning-quick data access.

HARD DISK DRIVE

The 20 megabyte hard disk drive you install internally gives you greater data storage capacity and access speed.

AT-COMPATIBLE COMPUTER

80286 CPU (12 MHz clock, 0 wait states), 1 meg RAM (expandable to 4 meg), 1.2 meg high-density floppy disk drive.

DIGITAL MULTIMETER

Professional test instrument for quick and easy circuit measurements.

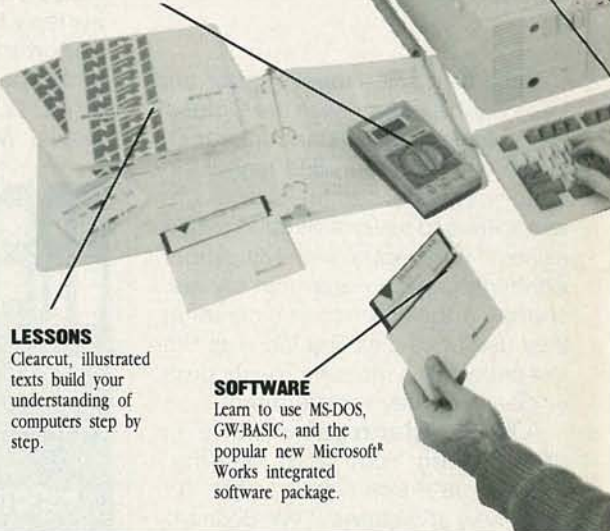

LESSONS

Clearcut, illustrated texts build your understanding of computers step by step.

SOFTWARE

Learn to use MS-DOS, GW-BASIC, and the popular new Microsoft® Works integrated software package.

NEW!



New! Training now includes Ultra-X diagnostic hardware and software for quick, accurate troubleshooting!

Now NRI takes your hands-on computer servicing experience an important step further: Now you train with and keep the remarkable R.A.C.E.R. plug-in diagnostic card and QuickTech diagnostic software from Ultra-X—professional diagnostic tools that make computer troubleshooting fast and accurate.

Using these state-of-the-art tools, you learn to quickly identify and service virtually any computer

in school, on the job, how to troubleshoot and like NRI

MONITOR

High-resolution, nonglare, 12" TTL monochrome monitor with tilt and swivel base.

TECHNICAL MANUALS

You get "inside" your AT-compatible computer system with exclusive NRI Training Kit Manuals plus technical specs direct from the manufacturer.

DISCOVERY LAB

Complete breadboarding system to let you design and modify circuits, diagnose and repair faults.

DIGITAL LOGIC PROBE

Using your logic probe, you get firsthand experience analyzing digital circuit operation.



No experience needed... NRI builds it in

You need no previous experience in computers or electronics to succeed with NRI. You start with the basics, following easy-to-read instructions and diagrams, moving step by step from the fundamentals of electronics to sophisticated computer servicing techniques.

With NRI's unique Discovery Learning Method, you're sure to get the kind of practical, hands-on experience that will make you fully prepared to take advantage of every opportunity in today's top-growth computer service field.

You learn at your own convenience, in your own home. No classroom pressures, no night school, no need to quit your present job until you're ready to make your move. And all throughout your training you've got the full support of your personal NRI instructor and the entire NRI technical staff, always ready to answer your questions and help you achieve your training goals.

Your FREE NRI catalog tells more

Send today for your free, full-color catalog describing every aspect of NRI's innovative computer training, as well as hands-on training in video/audio servicing, telecommunications, industrial electronics, and other growing, high-tech career fields.

If the coupon is missing, write to NRI School of Electronics, McGraw-Hill Continuing Education Center, 4401 Connecticut Avenue, NW, Washington, DC 20008.

AT is a registered trademark of International Business Machines Corporation. R.A.C.E.R. and QuickTech are registered trademarks of Ultra-X, Inc.

problem on XT, AT 80286/80386, and compatible machines. You discover how to use the R.A.C.E.R. card to identify individual defective RAM chips, locate interfacing problems, and pinpoint defective support chips. Plus you learn to use your QuickTech diagnostic software to test the system RAM and such peripheral adapters as parallel printer ports, serial communications ports, video display memory, and floppy and hard disk drives.

Only NRI gives you such confidence-building, real-world experience. Only NRI gives you both the knowledge and the professional tools to succeed as today's in-demand computer service technician.

SEND TODAY FOR FREE CATALOG

NRI Schools

McGraw-Hill Continuing Education Center
4401 Connecticut Avenue, NW, Washington, DC 20008



For career courses approved under GI Bill, check for details.

✓ CHECK ONE FREE

CATALOG ONLY

- Microcomputer Servicing
- TV/Video/Audio Servicing
- Telecommunications
- Industrial Electronics & Robotics
- Security Electronics
- Electronic Music Technology
- Basic Electronics

- Computer Programming
- PC Systems Analysis
- PC Software Engineering Using C
- Desktop Publishing & Design
- Word Processing Home Business
- Paralegal
- Fiction/Nonfiction Writing
- Automotive Servicing

- Building Construction
- Air Conditioning, Heating, & Refrigeration
- Electrician
- Small Engine Repair
- Locksmithing
- Bookkeeping & Accounting

Name _____ (please print) _____ Age _____

Address _____

City/State/Zip _____ Accredited Member, National Home Study Council 3-071

**DIGITAL VIDEO STABILIZER
ELIMINATES ALL VIDEO COPY
PROTECTIONS**



While watching rental movies, you will notice annoying periodic color darkening, color shift, unwanted lines, flashing or jagged edges. This is caused by the copy protection jamming signals embedded in the video tape, such as Macrovision copy protection. Digital Video Stabilizer: RXII completely eliminates all copy protections and jamming signals and brings you crystal clear pictures.

WARNING :
SCO Electronics and RXII dealers do not encourage people to use the Digital Video Stabilizer to duplicate rental movies or copyrighted video tapes. RXII is intended to stabilize and restore crystal clear picture quality for private home use only.

FEATURES:

- Easy to use and a snap to install
- State-of-the-art integrated circuit technology
- 100% automatic - no need for any troublesome adjustments
- Compatible to all types of VCRs and TVs
- The best and most exciting Video Stabilizer in the market
- Light weight (8 ounces) and Compact (1x3.5x5")
- Beautiful deluxe gift box
- Uses a standard 9 Volt battery which will last 1-2 years.

(Dealers Welcome)

To Order: \$49.95 ea + \$4 for FAST UPS SHIPPING
1-800-445-9285 or **516-568-9850**
Visa, M/C, COD M-F: 9-6 (battery not included)
SCO ELECTRONICS INC.
Dept CRE 7 581 W. Merrick Rd. Valley Stream NY 11580
Unconditional 30 days Money Back Guarantee

CIRCLE 185 ON FREE INFORMATION CARD

**CABLE TV
DESCRAMBLER**
How You Can Save Money
on Cable Rental Fees



- 1 Unit 5+
- Jerrold SB w/Tri-Bi.....\$99.....\$70
 - SuperTri-Bi (TBM).....\$109.....\$75
 - Jerrold 450 combo.....\$189.....\$139
 - Scientific Atlanta.....\$109.....\$75
 - SA 8536.....\$250.....\$195
 - Pioneer.....\$109.....\$79
 - Oak KN12 (w/VIS).....\$109.....\$65
 - Hamlin MLD 1200.....\$89.....\$59
 - Tocom.....\$169.....\$129
 - Stargate converter.....\$89.....\$69
 - Panasonic TZPC145.....\$99.....\$79

**US Cable will
Beat Anyone's
Price
Advertised in
this Magazine!**

30 Days Money Back Guarantee
Free 16 page Catalog

Visa, M/C, COD or send money order to:
US Cable TV Inc. Dept. KRE7

4100 N. Powerline Rd., Bldg F-4
Pompano Beach, FL 33073

1-800-445-9285

For Our Record

I, the undersigned, do hereby declare under penalty of perjury that all products purchased, now and in the future, will only be used on Cable TV systems with proper authorization from local officials or cable company officials in accordance with all applicable federal and state laws. FEDERAL AND VARIOUS STATE LAWS PROVIDE FOR SUBSTANTIAL CRIMINAL AND CIVIL PENALTIES FOR UNAUTHORIZED USE.
Date: _____
Signed: _____

No Florida Sales!

CIRCLE 186 ON FREE INFORMATION CARD

FOILED BY COILS

The project entitled "Build This Magnetic Field Meter" (**Radio-Electronics**, April 1991) brought to mind a difficulty I have always had with the archaic "art" of coil winding. Factory-made coils are constructed using highly specialized jigs and fixtures, so that their specified values are usually reliable. Since the average hobbyist is equipped with a maximum of two hands, it is not illogical to presume that a fairly complex home-built device is required to lay down magnetic wire on a coil form with acceptable results. (Acceptable, to me, means rigidly anchored, evenly spaced windings that conform to 95% of a comparable factory standard. In other words, why stuff a circuit board with high-quality silicon if the interfacing discrete components are not approximately equal in quality reliability?)

The one-meter-long coil shown in Fig. 6 of the article raises my coil-winding hackles to a fever pitch! The extremely wide variations in tolerance that would surely result from fabricating that elephantine coil makes me wonder about using that

circuit to calibrate the Gaussmeter.

At the same time, I understand that hand-wound coils have been used for several decades by countless electronics enthusiasts with satisfactory results. Maybe I'm looking for precision in every aspect of my work, even when it's not required.

DAVID KATZNELSON
Willingboro, NJ

I appreciate and agree with your concern over the difficulties of winding the large calibration coil. I offer the following suggestions: Wind the coil concentrically first on a fixed form, and then stretch it out to the one meter length; or use an alternative non-solenoid design, such as two separate coils in a Helmholtz-type arrangement. Please note that, in recognition of exactly your kind of concerns, the meter's pickup coil is integrated in the PC board.

REINHARD METZ

BATTERY TESTERS

Thank you for the "Battery Testers" section in *Hardware Hacker* (**Radio-Electronics**, April 1991). It was short, yet provided a lot of useful information. However, I would like to point out that the tester included with Duracell's AA-type cells measures 500 mA only when 1.5 volts are being tested. Since power (and a resistor's heat) is measured in watts, not amperes, the "milliammeter" is actually a wattmeter. It should show 0.75 watts full-scale (1.5 volts times 0.5 amps).

DARREN HOM
Walnut Creek, CA

GOTTCHA!

Regarding the "Poor Man's Laser Printer" (**Radio-Electronics**, April 1991): First, most of today's copiers would detect the exposure lamp (light bulb) not illuminating and would generate a fault code. Lamp illumination is detected by a CDS cell pointed at the lamp or on the lamp regulator board. Second, it would be simpler to pull a lead off the lamp rather than to remove the lamp, if you have a copier that does not detect the lamp illumination. Lamp removal is not usually a DIY project. Finally, the focal plane of copiers is at the surface of the original glass, so resolution might be a problem due to the monitor's curvature.

MIKE ZYCH
Elk Grove, IL

R-E

**ATTENTION!
ELECTRONICS
TECHNICIANS**



**EARN YOUR
B.S.E.E.
DEGREE
THROUGH HOME STUDY**

Our New and Highly Effective Advanced-Placement Program for experienced Electronic Technicians grants credit for previous Schooling and Professional Experience, and can greatly reduce the time required to complete Program and reach graduation. No residence schooling required for qualified Electronic Technicians. Through this Special Program you can pull all of the loose ends of your electronics background together and earn your B.S.E.E. Degree. Upgrade your status and pay to the Engineering Level. Advance Rapidly! Many finish in 12 months or less. Students and graduates in all 50 States and throughout the World. Established Over 40 Years! Write for free Descriptive Literature.

**COOK'S INSTITUTE
OF ELECTRONICS ENGINEERING**

CI 4251 CYPRESS DRIVE
JACKSON, MISSISSIPPI 39212

CIRCLE 58 ON FREE INFORMATION CARD

48 HOUR SHIPPING

ELENCO & HITACHI PRODUCTS AT DISCOUNT PRICES

48 HOUR SHIPPING

Hitachi RSO Series

(Portable Real-time Digital Storage Oscilloscopes)

VC-6023 - 20MHz, 20MS/s	\$99/mo*
VC-6024 - 50MHz, 20MS/s	\$120/mo*
VC-6025 - 50MHz, 20MS/s	\$135/mo*
VC-6045 - 100MHz, 40MS/s	\$125/mo*
VC-6145 - 100MHz, 100MS/s	\$200/mo*

RSOs from Hitachi feature roll mode, averaging, save memory, smoothing, interpolation, pretriggering, cursor measurements. These scopes enable more accurate, simpler observation of complex waveforms, in addition to such functions as hardcopy via a plotter interface and waveform transfer via the RS-232C interface. Enjoy the comfort of analog and the power to digital.

LEASING AVAILABLE

For all Hitachi Scopes - Call for details

* Based on 24 months except V-1150, VC-6045, VC-6145 (36 months)

Hitachi Portable Scopes

DC to 50MHz, 2-Channel, DC offset function, Alternate magnifier function

V-525 - CRT Readout, Cursor Meas.	\$1,025
V-523 - Delayed Sweep	\$995
V-522 - Basic Model	\$895
V-422 - 40MHz	\$795
V-223 - 20MHz delayed sweep	\$695
V-212 - 20MHz	\$425

HITACHI COMPACT SERIES SCOPES

This series provides many new functions such as CRT Readout, Cursor measurements (V-1085/1065/665), Frequency Ctr (V-1085), Swepttime Autoranging, Delayed sweep and Tripper Lock using a 6-inch CRT. You don't feel the compactness in terms of performance and operation.

V-660 - 60MHz, Dual Trace	\$1,195
V-665 - 60MHz, DT, w/cursor	\$1,345
V-1060 - 100MHz, Dual Trace	\$1,425
V-1065 - 100MHz, DT, w/cursor	\$105/mo*
V-1085 - 100MHz, QT, w/cursor	\$125/mo*
V-1100A - 100MHz, Quad Trace	\$125/mo*
V-1150 - 150MHz, Quad Trace	\$115/mo*

20MHz Elenco Oscilloscope

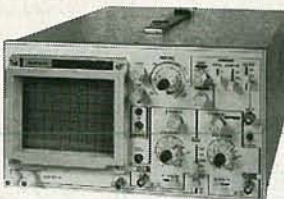

\$375

- MO-1251**
- Dual Trace Component Tester
 - 6" CRT
 - X-Y Operation
 - TV Sync
 - 2 P-1 Probes

FREE DMM

with purchase of ANY SCOPE

SCOPE PROBES

P-1 65MHz, 1x, 10x	\$19.95
P-2 100MHz, 1x, 10x	\$23.95

Elenco 35MHz Dual Trace



Good to 50MHz **\$495**

- MO-1252**
- High luminance 6" CRT
 - 1mV Sensitivity
 - 6KV Acceleration Voltage
 - 10ns Rise Time
 - X-Y Operation • Z Axis
 - Delayed Triggering Sweep
 - Includes 2 P-1 Probes

All scopes include probes, schematics, operators manual and 3 year (2 yrs for Elenco scopes) world wide warranty on parts & labor. Many accessories available for all Hitachi scopes. Call or write for complete specifications on these and many other fine oscilloscopes.

B + K TEST EQUIPMENT

Call for special price

Digital Capacitance Meter



CM-1550B

\$58.95

- 9 Ranges
- .1pf-20,000ufd
- .5% basic acy.
- Zero control w/ Case
- Big 1" Display

Digital LCR Meter



LC-1801

\$125

- Measures: Coils 1uH-200H
- Caps .1pf-200uf
- Res .01-20M



Multimeter with Capacitance & Transistor Tester

- \$55 CM-1500B**
- Reads Volts, Ohms
 - Current, Capacitors, Transistors and Diodes / with case

Big 1" Display

FLUKE MULTIMETERS

Call for special price

Quad Power Supply XP-580



\$59.95

- 2-20V @ 2A
- 12V @ 1A
- 5V @ 3A
- -5V @ .5A

Fully regulated and short circuit protected

Triple Power Supply XP-620



Assembled \$65

Kit \$45

- 2 to 15V @ 1A,
- -2 to -15V @ 1A
- (or 4 to 30V @ 1A)
- and 5V @ 3A

All the desired features for doing experiments. Features short circuit protection, all supplies

AM/FM Transistor Radio Kit with Training Course

Model AM/FM 108

\$26.95

- 14 Transistors • 5 Diodes
- Makes a great school project



True RMS 4 1/2 Digit Multimeter

M-7000

\$135

- .05% DC Accuracy
- .1% Resistance
- with Freq. Counter and Deluxe Case

GF-8016 Function Generator with Freq. Counter



\$249

- Sine, Square, Triangle
- Pulse, Ramp, .2 to 2MHz
- Freq Counter .1 - 10MHz

GF-8015 without Freq. Meter \$179

Function Generator Blox



#9600

\$28.95

- Provides sine, triangle, square wave from 1Hz to 1MHz
- AM or FM capability

Learn to Build and Program Computers with this Kit

Includes: All Parts, Assembly and Lesson Manual

Model MM-8000

\$129.00



Starting from scratch you build a complete system. Our Micro-Master trainer teaches you to write into RAMs, ROMs and run a 8085 microprocessor, which uses similar machine language as IBM PC.

Robotics Kit for above (MM8010) 71.95

Wide Band Signal Generators



SG-9000 \$129

- RF Freq 100K-450MHz AM Modulation of 1KHz Variable RF output
- SG-9500 w/ Digital Display & 150MHz built-in Counter \$249

XK-500 DIGITAL / ANALOG TRAINER

A complete mini-lab for building, testing, prototyping analog and digital circuits. Elenco's Digital / Analog Trainer is specially designed for school projects, with 5 built-in power supplies. Includes a function generator with continuously variable, sine, triangular, square wave forms. All power supplies are regulated and protected against shorts.

POWER SUPPLIES

- Variable Power Supply
- +1.25 to 20VDC @ .5 Amp (+1.25 to 15VDC @ 1 Amp)
- -1.25 to -20VDC @ .5 Amp (-1.25 to -15VDC @ 1 Amp)
- +12 VDC @ 1 Amp
- -12VDC @ 1 Amp
- +5VDC @ 1Amp
- 30VAC Center tapped @ 15VAC at 1Amp

ANALOG - SECTION

- Function Generator Sine, Triangular, Square wave forms
- Frequency adjustable in five ranges from 1 to 100KHz
- Fine frequency adjust
- Amplitude adjust
- DC offset
- Modulation FM-AM

DIGITAL - SECTION

- Eight data switches
 - Two no bounce logic switches
 - Eight LED readouts TTL buffered
 - Clock frequency 1 to 100KHz
 - Clock amplitude 5VPP square wave
- BREADBOARDS**
- 2 Breadboards, each contain: 840 tie points (total 1,680)

\$139.95 Assembled
\$119.95 Kit



WE WILL NOT BE UNDERSOLD!
UPS Shipping: 48 States 5%
(\$3 Min \$10 Max) Shipping
IL Res., 7% Tax FAX: 708-520-0085

C & S SALES INC.
1245 Rosewood, Deerfield, IL 60015
(800) 292-7711 (708) 541-0710



15 Day Money Back Guarantee
2 Year Warranty Prices Subject to Change
WRITE FOR FREE CATALOG

JULY 1991

AOR Scanners.

Great Performance. Great Service. Great Value.

Free Freight
25-Day Money-Back Guarantee
Toll-Free Service and Support
No Credit Card Surcharge
One Year Warranty



AR1000

\$399

1000 Channels. 8-600MHz, 805-1300MHz

Standard Features:

- Extremely compact size.
- Continuous coverage (except UHF TV 600-805)
- Antenna attenuator switch, 10db.
- Manual tuning knob.
- Earphone jack, 3.5mm.
- AM, FM and wide band FM tuning modes.
- Backlighted LCD display.
- 10 Scan Banks, 10 Search Banks.
- Selectable Priority Channel.
- Delay, Hold Features.
- Selectable Search Increments, 5-955KHz.
- Permanent memory backup.
- 4 AA Ni Cad batteries included.
- AC adaptor/charger.
- Carry Case.
- Cigarette Lighter Charger.
- Belt Clip.
- Earphone.

Options:

- External Speaker. Mobile Mount. MS190 \$19.50
- Extended Warranty. 2/3 yrs \$45/\$55

Specifications:

- Coverage: 8-600, 805,1300MHz
- Sensitivity: .35uV NFM, 1.0uV WFM, 1.0AM
- Speed: 20 ch/sec. scan. 40 ch/sec. search
- IF: 561.225, 58.075, 455KHz or 10.7MHz
- Increments: 5 to 955KHz selectable/ 5 or 12.5 steps.
- Audio: .4 Watts
- Power: Input 9 - 13.8 V. DC
- Antenna: BNC
- Display: LCD
- Dimensions: 6 7/8H x 1 3/4D x 2 1/2W. 12oz wt.

AR950

\$239



100 Channels. Low, Air, High, UHF & 800MHz.

Standard Features:

- Extremely compact size.
- Unrestricted 800MHz coverage.
- 100 channels permanent memory.
- Earphone Jack & Attenuator.
- Delay, Hold features.
- Channel 1 Priority.
- 5 Scan Banks, 5 Search Banks.
- Telescopic and Flexible Antennas w/ BNC connector.
- AC & DC Power cords w/ mtng hardware.
- One Year Limited Warranty.

Options:

- Base type antenna
25 to 1000MHz w 50' coax. AS300 \$59.95
- Mag Mnt Mobile Antenna. 15' coax. MA100 \$25.00
- Cigarette Lighter power adaptor. CP100 \$4.00
- External Speaker
with mobile mount. MS100 \$19.50
- Extended Warranty. 2/3 yrs \$40/\$55

Specifications:

- Coverage: 27-54, 108-174, 406-512, 830-950MHz
- Sensitivity: .4uV Lo,Hi. .8uV Air. .5uV UHF. 1.0uV 800
- Scan Speed: 15 ch/sec.
- IF: 21.4MHz, 455KHz
- Increments: 10,12.5,25,30
- Audio: 1W
- Power: 12.8VDC, 200MA
- Antenna: BNC
- Display: LCD w/backlight
- Dimensions: 2 1/4H x 5 5/8W x 6 1/2D. 14oz wt.

We offer 100's of communications products.

AR3000

\$995

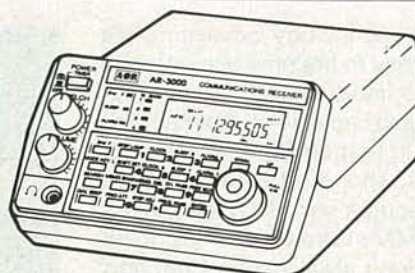

400 Channels. 100KHz to 2036MHz.

Standard Features:

- Extremely compact size.
- Continuous coverage
- Attenuation Programmable by Channel.
- Manual tuning knob.
- Tuning increments down to 50Hz.
- AM, FM, wide band FM, LSB, USB, CW modes.
- Backlighted LCD display.
- 4 Scan and Search Banks, Lockout in Search.
- 4 Priority Channels.
- RS232 control through DB25 connector.
- Delay, Hold Features.
- 15 band pass filters, GaAsFET RF amp.
- Sleep and Alarm Features.
- AC adaptor/charger. DC power cord.
- Telescopic Antenna.

Options:

- | | | |
|---------------------------------|-------|----------|
| Earphone. | EP200 | \$2.00 |
| External Speaker. Mobile Mount. | MS190 | \$19.50 |
| Extended Warranty. 2/3 yrs. | | \$65/75 |
| Mobile Mounting Bracket. | MM1 | \$14.90 |
| RS232 Control Package | SCS3 | \$295.00 |
- (software & cable) offers spectrum display and database.

Specifications:

- | | |
|--------------|---|
| Coverage: | 100KHz - 2036MHz |
| Sensitivity: | .35uV NFM, 1.0uV WFM,
1.0AM/SSB/CW |
| Speed: | 20 ch/sec. scan. 20ch/sec. search |
| IF: | 736.23, (352.23) (198.63) 45.0275, 455KHz |
| Increments: | 50Hz and greater |
| Selectivity: | 2.4Khz/-6db (SSB) 12KHz/-6db
(NFM/AM) |
| Audio: | 1.2 Watts at 4 ohms |
| Power: | Input 13.8 V. DC 500mA |
| Antenna: | BNC |
| Display: | LCD |
| Dimensions: | 3 1/7H x 5 2/5W x 7 7/8D Wt. 2lb 10oz. |

AR2500

\$499

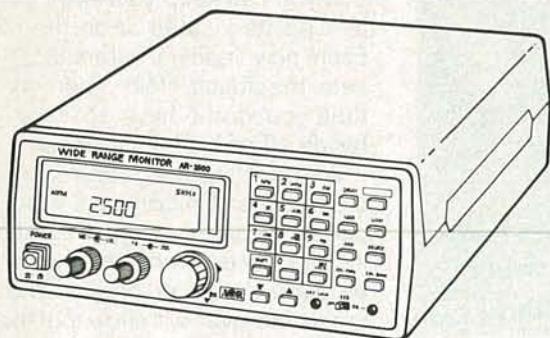

2016 Channels. 1 MHz to 1500 MHz

Standard Features

- Continuous coverage
- AM, FM, wide band FM, & BFO for SSB, CW.
- 64 Scan Banks.
- 16 Search Banks.
- RS232 port built in.
- Includes AC/DC pwr crd. Antenna, Mntng Brckt.
- One Year Limited Warranty.

Options:

- | | | |
|---------------------------------|-------|----------|
| Earphone. | EP200 | \$2.00 |
| External Speaker. Mobile Mount. | MS190 | \$19.50 |
| Extended Warranty. 2/3 yrs. | | \$65/75 |
| Mobile Mounting Bracket. | MM1 | \$14.90 |
| RS232 Control Package | SCS2 | \$295.00 |
- (software & cable) offers spectrum display and database.

Specifications:

- | | |
|--------------|---------------------------------------|
| Coverage: | 1 MHz - 1500MHz |
| Sensitivity: | .35uV NFM, 1.0uV WFM,
1.0AM/SSB/CW |
| Speed: | 38 ch/sec. scan. 38 ch/sec. search |
| IF: | 750.00, 45.0275, 5.5MHz 455KHz |
| Increments: | 5,12,5,25 KHz |
| Audio: | 1.2 Watts at 4 ohms |
| Power: | Input 13.8 V. DC 300mA |
| Antenna: | BNC |
| Display: | LCD, backlighted. |
| Dimensions: | 2 1/4H x 5 5/8W x 6 1/2D Wt. 1lb. |

To Order Call 1•800•445•7717

In All 50 States and Canada. 24 Hours a Day. Fax Orders: 1-800-448-1084, 24 Hours a Day.

ACE Communications Monitor Division 10707 E. 106th Street, Fishers, IN 46038

Int'l Voice# 317-842-7115. Int'l Fax# 317-849-8794.

Service and Support Lines: Mon-Fri 9a.m. to 9p.m., Saturday 10-4. EST

MasterCard, Visa, American Express, Checks, Approved P.O.'s. & C.O.D. (add 5.00)

Prices and specifications subject to change.

EQUIPMENT REPORTS

Fluke Model 79 DMM

As technology advances, it's easy to become accustomed to (read: spoiled by) the new features and capabilities that become possible in test equipment. Take, for example, the digital multimeter. We've become so used to having our 4-digit DMM stuffed in our hip pocket that we don't always appreciate how much things have changed in the last 15 years or so.

Back then, DMM's were still considered somewhat exotic. If you were lucky enough to have access to one, it was on a test bench somewhere. The handheld multimeter didn't make an appearance until Fluke (John Fluke Manufacturing Company, Inc. P.O. Box 9090, Everett, WA 98206-9090; 206-347-6100) introduced their model in 1976. Although we're sure that some of our younger readers never knew a world without DMM's, most of us can remember the excitement with each new introduction and improvement. Of course, we also remember the analog vs. digital battles that are, in some quarters, still going on between the respective proponents.

In 1983, Fluke introduced their *70 Series* handheld DMM's. Since then, they've sold some 2 million units. (According to the manufacturer, Fluke sells a *70-Series* meter "every minute of every day.") What do you do when you have a family of DMM's that are obviously well liked, but that are almost ten years old?

If you're Fluke, you introduce a "new-and-improved" *70 Series*, and call it the *70 Series II*. The new series consists of enhanced versions of five models in the original *70 Series*, and three new models. The meters retain the well-known styling of the originals, especially the single off-center rotary selector that makes one-handed operation comfortable.

The model 79

We examined one of the all-new meters, the model 79. As the high-end meter in the series, the 79 also has the highest price: \$185. (The lowest priced meter in the series,



CIRCLE 10 ON FREE INFORMATION CARD

Updating a classic line of digital multimeters

which is also the lowest-priced meter Fluke has ever sold, is the model 70, for \$69.)

The model 79 features a 4-digit, 4000-count display, and a 63-segment analog bargraph. DC voltage is measured over six ranges (40 mV–4000 V), with a basic accuracy of 0.3%. As with all other modes, the ranges can be manually or automatically selected. AC voltage is measured over five ranges (400 mV–4000 V), with a basic accuracy of 1.0%.

AC and DC current are measured over four ranges up to a high limit of 10 amperes. Basic accuracy is 0.5% DC, and 1.5% AC. Resistance is measured over seven ranges (400 ohms–40 megohms) with a basic accuracy of 0.4%.

The model 79 also offers a frequency-counter mode that is capable of measuring from 1 Hz to more than 20 kHz with an accuracy of 0.01%. Interestingly, the meter offers a 9999-count display in the frequency mode. Even more interesting is that the bargraph portion of the display will show the AC voltage whose frequency is being measured while the digital display shows the frequency.

Capacitance measurements are also possible, from 10 pF to 999.9 μ F with an accuracy of 1.9%, and from 999.9 μ F to 9999 μ F with an accuracy of 10%.

A diode-test feature, audible con-

tinuity beeper, and automatic sleep mode are standard on all meters in the *70 Series II*, as is Touch Hold, Fluke's method of capturing stable signals and holding the display so that you can keep your eyes on your test points instead of on the meter. Each new reading automatically resets the Touch Hold "memory" so that you don't have to take your hands off your probes, either.

Another feature featured on the model 79 is "Smoothing," which displays a running average of eight readings so that even unstable signals can produce stable displays. (The bargraph, however, will show that the signals are unstable.)

The model 79 also offers a low-ohms range, which provides 0.01-ohm resolution. Zero calibration is also available.

The meter has an elegant design. Aside from the eight-position function selector, there is only one other control: a push button in the center of the rotary switch. The push button takes on different functions depending on how long it's held down. Tap it lightly, and you put the meter in the manual-ranging mode. Tap it again quickly, and you change the meter's range.

If you hold the button down for one second, you put the meter back in the autorange mode. If you're in the continuity position, holding the button for one second puts the meter in the low-ohms mode.

If you hold the center button for two seconds, the meter is put in the Touch-Hold mode, or, if you're in the continuity mode, you put the meter in the diode-test mode. Alternatively, in the resistance mode, the meter enters the capacitance mode.

On paper, that might sound confusing. In use, however, it's quite simple. And, even if you forget how it works, a well-designed front-panel makes it obvious.

Overall, we're quite impressed with the *70 Series II* multimeters. Judging from these new-and-improved models, we can hardly wait for Fluke's 80 Series to get a little older!

R-E

Radio Electronics® mini-ADS



THE MODEL WTT-20 IS ONLY THE SIZE OF A DIME, yet transmits both sides of a telephone conversation to any FM radio with crystal clarity. Telephone line powered - never needs a battery! Up to ¼ mile range. Adjustable from 70-130 MHZ. Complete kit **\$29.95 + \$1.50 S + H**. Free Shipping on 2 or more! COD add \$4. Call or send VISA, MC, MO. **DECO INDUSTRIES, Box 607, Bedford Hills, NY 10507. (914) 232-3878.**

CIRCLE 127 ON FREE INFORMATION CARD



COMPUTER KITS, BOARDS & COMPONENT PARTS. Designed to the highest degree of *quality* and *reliability* available today. They're fun, easy to build, educational, IBM compatible, very *powerful*, and at great prices. All items are pre-tested, include a full year warranty, step by step assembly manual, and free tech support. Assembly available at no extra charge. For free catalog contact: **GENERAL TECHNICS, P.O. BOX 2676, LAKE RONKONKOMA, NY 11779**, or call **(516) 981-9473**. VISA, MasterCharge, American Express, COD.

CIRCLE 183 ON FREE INFORMATION CARD



FREE CATALOG! ELECTRONIC TOOLS & TEST EQUIPMENT. Jensen's new Master Catalog, available free, presents major brand name electronics tools, tool kits, and test instruments, plus unique, hard-to-find products for assembly and repair and custom field service kits available only from Jensen. All fully described and illustrated. Enjoy free technical support and rapid, post-paid delivery anywhere in the Continental USA. **JENSEN TOOLS INC., 7815 S. 46th St., Phoenix, AZ 85044. Phone: 602-968-6231; FAX: 1-800-366-9662.**

CIRCLE 115 ON FREE INFORMATION CARD

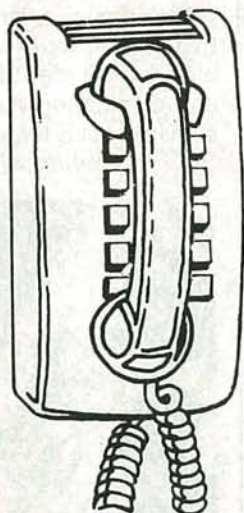

ELEVEN-PIECE RACHET TOOL KIT Includes reversible ratchet handle, extension bar, six bits, two precision screwdrivers, and a cutter. Comes in fitted case. Get one for your shop, another for your car, another for your tool kit. To order send **\$11.75 USA** shipping only. **ELECTRONIC TECHNOLOGY TODAY INC., PO Box 240, Massapequa Park, NY 11762-0240.**



APPLIANCE REPAIR HANDBOOKS—13 volumes by service experts; easy-to-understand diagrams, illustrations. For major appliances (air conditioners, refrigerators, washers, dryers, microwaves, etc.), elec. housewares, personal-care appliances. Basics of solid state, setting up shop, test instruments. **\$2.65 to \$7.90 each**. Free brochure. **APPLIANCE SERVICE, P.O. Box 789, Lombard, IL 60148. (708) 932-9550.**

CIRCLE 84 ON FREE INFORMATION CARD



CABLE TV CONVERTERS AND DE-SCRAMBLERS SB-3 \$79.00 TRI-BI \$95.00 MLD-\$79.00 M35B \$69.00 DRZ-DIC \$149.00. Special combos available. We ship COD. Quantity discounts. Call for pricing on other products. Dealers wanted. **FREE CATALOG.** We stand behind our products where others fail. One year warranty. **ACE PRODUCTS, P.O. Box 582, Saco, ME 04072 1 (800) 234-0726.**

CIRCLE 75 ON FREE INFORMATION CARD

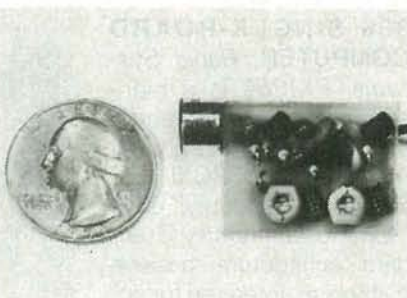

SIMPLY SNAP THE WAT-50 MINIATURE FM TRANSMITTER on top of a 9v battery and hear every sound in an entire house up to 1 mile away! Adjustable from 70-130 MHZ. Use with any FM radio. Complete kit **\$29.95 + \$1.50 S + H**. Free shipping on 2 or more! COD add \$4. Call or send VISA, MC, MO. **DECO INDUSTRIES, Box 607, Bedford Hills, NY 10507. (914) 232-3878.**

CIRCLE 127 ON FREE INFORMATION CARD

CALL NOW AND RESERVE YOUR SPACE

- 6 x rate \$940.00 per each insertion.
- Fast reader service cycle.
- Short lead time for the placement of ads.
- We typeset and layout the ad at no additional charge.

Call **516-293-3000** to reserve space. Ask for Arline Fishman. Limited number of pages available. Mail materials to: mini-ADS, RADIO-ELECTRONICS, 500-B Bi-County Blvd., Farmingdale, NY 11735.

FAX: 516-293-3315

NEW PRODUCTS

Use the Free Information Card for more details on these products.

FUNCTION GENERATOR.

For engineers who occasionally need to create their own waveforms, the Philips PM 5139 function generator from John Fluke offers both an arbitrary waveform-programming facility via IEEE-488 bus and general-purpose functions in a single instrument. The instrument allows the engineer to create servo drive waveforms, acoustic and sonar bursts, mechanical waveforms for bump testing and simulation, and brain and heart waves, among others. Its arbitrary waveform facility allows the PM 5139 to play back a custom-design waveform when and where it is needed and, if required, subject it to any of the modulation modes: AM, FM, gating, bursts, phase shift keying, and linear or logarithmic frequency sweeps. Six different arbitrary waves can be loaded into memory and individually selected; within about 70 ms, the new arbitrary wave is available at the gen-



CIRCLE 16 ON FREE INFORMATION CARD

erator output.

Instead of the standard rotary switches, knobs, and pushbuttons found in classic benchtop function generators, the PM 5139 offers a logical array of parameter-selection and control keys along with one rotary knob. To make a numerical setting, the user touches the relevant key and actuates the rotary knob to dial in the correct readings. All manual settings can also be achieved by remote control across the IEEE-488 bus. All parameters—frequency, waveform, amplitude, offset, and modulation—are

shown on a single, large, backlit LCD readout.

The PM 5139 features a very flat amplitude response and an accuracy to within ± 2 ppm over the complete 0.1-MHz to 20-MHz frequency range. In the low-frequency range, five of the ten standard waveforms can be varied in duty cycle from 1% to 99% with a 1% resolution and $\pm 0.1\%$ accuracy.

The PM 5139 has a base U.S. list price of \$4190, or \$4690 with a GPIB.—**John Fluke Mfg. Co., Inc.**, P.O. Box 9090, Everett, WA 98206; 800-44-FLUKE.

34th Street, Seattle, WA 98103; Phone: 206-547-8311; Fax: 206-548-0322.

INDICATING FUSE.

An innovation in fuse technology used in the 2AG Indicating Slo-Blo fuse from LittleFuse, Inc. provides instant identification of an open (blown) fuse. Under normal operating conditions, the fuse's glass body is transparent; when the fuse blows, the body dramatically darkens to a yellow/brown color, taking the guesswork out of blown-fuse identification and eliminating time-consuming circuit testing. The 2AG Indicating Slo-Blow

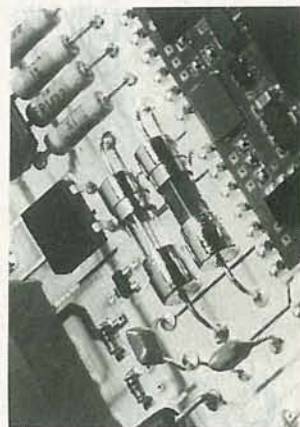

CIRCLE 18 ON FREE INFORMATION CARD

386 SINGLE-BOARD COMPUTER.

Rapid Systems' PX1260 is a high-speed, high-performance, 33-MHz, 386-based CPU module for the PCXI "PC Extended for Industry" EISA "Extended Industry Standard Architecture" passive backplane. Intended for applications in EISA workstations, production tests, modular rugged PC's, factory automation, and networks, the PCXI is a modular, industrial PC based on a 13-slot passive backplane. The plug-in



CIRCLE 17 ON FREE INFORMATION CARD

CPU module features a 3½-inch floppy drive; an

optional integrated 40-megabyte hard-disk drive is available. The PX1260 is based on a single-board computer and is completely enclosed in a metal chassis to shield EMI/RFI emissions. Two serial communication ports, one parallel port, and the 3½-inch floppy drive, along with the keyboard connector and reset button, are located on the front of the module for easy access.

The PX1260 costs \$5995.—**Rapid Systems, Inc.**, 433 North

can also be used to aid in design testing by showing a slight discoloration of the glass body if the current rating of the selected fuse is too low. The fuse provides the same quality and performance characteristics as the standard 2AG fuse. It is available with axial leads or in the cartridge style. A complete assortment of mounting accessories, including fuse blocks, panel-mount, or in-

Learn to Use Your Computer's Full Potential.

New Career Course from CIE!

If you've been hesitating about upgrading your computer skills because you couldn't find the time or locate the right program to teach you everything you need to know to be successful in today's world of computers, you'll be happy to hear that CIE's new career course can provide you with the computer technology curriculum you seek in an independent study program you can afford to invest your time in.

CIE's COMPUTER OPERATION and PROGRAMMING course was designed and developed by CIE to provide a complete overall understanding of the unlimited potential today's computers offer, once you learn and discover their full capabilities, in today's high tech environment. CIE's new computer course quickly provides you with the electronics fundamentals essential to fully understand and master the computer's technological potentials for your personal and professional advancement. Upon mastering the fundamentals you will move into high level language programming such as BASIC and C-Language and then use that programming in order to relate the interfacing of electronic hardware circuitry to programming software. As a graduate of the Computer Operation and Programming course, you will be able to successfully understand, analyze, install, troubleshoot, program and maintain the various types of electronic equipment used in business, manufacturing, and service industries.

Since 1934, CIE has been the world leader in home study electronics by providing our 150,000-plus graduates with the curriculum and hands-on training they've needed to become successful in



today's highly competitive and computer oriented society. As a CIE student you'll receive a first rate education from a faculty and staff with only one desire. Your future success!

We encourage you to look, but you won't find a more comprehensive computer course anywhere!

And it's a course designed to fit around your lifestyle and commitments today, so you can be assured of professional successes and financial gains tomorrow.

Please, do yourself a favor and send the attached card or fill out and mail the coupon below for more information about CIE's

Computer Operation and Programming course. Do It Today!

Computer not included with course

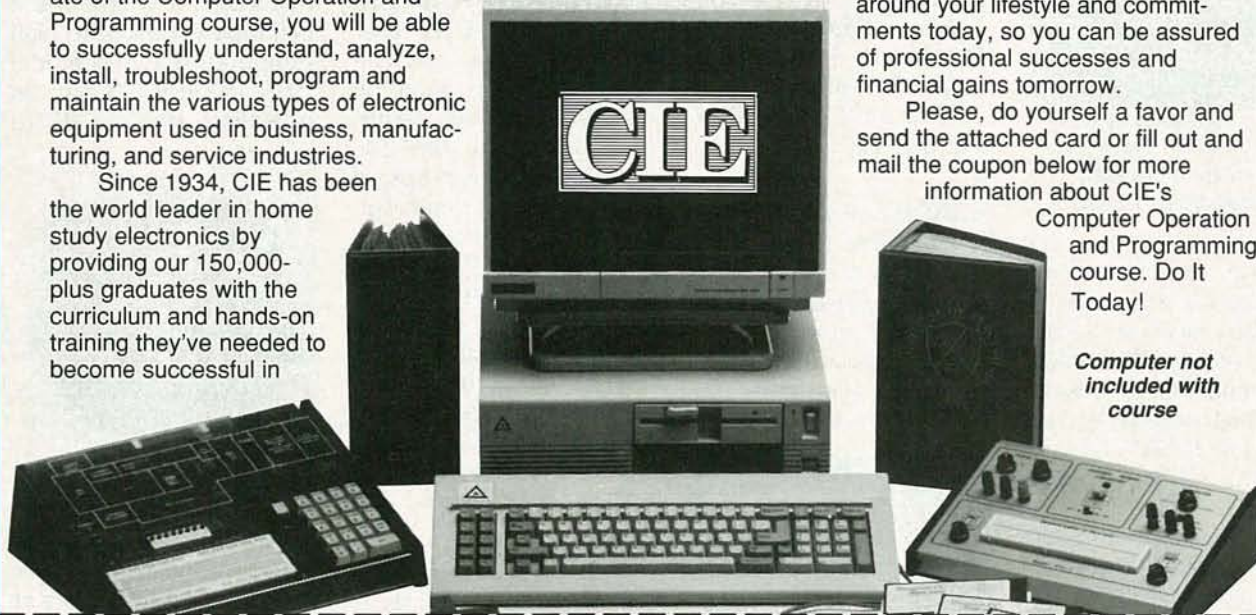

YES! I want to get started. Send me my CIE school catalog including details about the Associate Degree program (for your convenience, CIE will have a representative contact you - there is no obligation).

Print Name _____

Address _____ Apt. _____

City _____ State _____ Zip _____

Age _____ Area Code/Phone No. _____

Check box for G.I. Bulletin on Educational Benefits Veteran Active Duty



CLEVELAND INSTITUTE OF ELECTRONICS
1776 East 17th Street
Cleveland, Ohio 44114
(216) 781-9400



*A school of thousands.
A class of one.
Since 1934.*

AE18

line fuse holders and surface-mount clips are also available.

The *2AG Indicating Slo-Blo* fuse costs 38¢ in 5-piece quantities for cartridge types, 54¢ in 100-piece quantities for the axial lead style.—**Littelfuse, Inc.**, 800 East Northwest Highway, Des Plaines, IL 60016; Phone: 708-824-1188.

VIDEO FRAME GRABBER.

Two video digitizing systems for IBM-compatible computers are available from **IDEC Inc.** The *Supervision/8* is a 1/60-second image-capture system that lets users acquire a black-and-white image in 256 gray-scale levels using simple software controls. It consists of a half-size card that plugs into any slot and

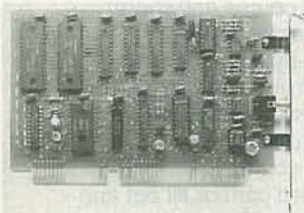

CIRCLE 19 ON FREE INFORMATION CARD

menu-driven software. The image is captured with a resolution of 256 pixels by 244 lines, and can be displayed on any HGC, CGA, EGA, and VGA monitors. The *Supervision/8* is compatible with IBM-compatible PC/XT/AT or 386 systems.

The *Supervision/16* (pictured), compatible with AT-compatible computers, has picture resolution of 512 pixels by 488 lines, with 256 shades of gray, and captures images in 1/30 second. With a super-VGA display, the picture rivals black-and-white TV-broadcast quality. The choice of display has no effect on the print quality, since the printed image is printed directly from the disk file image, not from the screen. Its high resolution makes

the *Supervision/16* suitable for scientific and engineering applications such as machine vision, inspection, medical imaging, and security.

Both video-frame grabbers provide automatic calibration of brightness and contrast, adjustable by the user. Images can be saved and recalled, printed out, or incorporated into documents using Pagemaker, Ventura Publisher, or any other compatible Gray Scale Graphics Program. Both packages contain the interface card, software on disk, owner's manual, and a one-year warranty.

The *Supervision/8* is available in kit form for \$169.95 (plus shipping and handling) and \$269.95 fully assembled; the *Supervision/16* costs \$369.95. (Shipping and handling, and 6% sales tax in Pennsylvania, are additional.)—**IDEC, Inc.**, 1195 Doylestown Pike, Quakertown, PA 18951; Phone: 215-538-2600; Fax: 215-538-2665.

BENCHTOP DC POWER SUPPLIES.

Understanding that not all engineers require high-end instruments on their benches, **Hewlett-Packard** has introduced two affordable, general-purpose benchtop DC



CIRCLE 20 ON FREE INFORMATION CARD

power supplies. Models *E3610A* (pictured) and *E3611A* both feature a high-performance linear design with ripple and noise less than 200 mV rms. The 30-watt power supplies feature dual-range outputs and CV/CC operation: CV mode for devices requiring

a constant voltage and CC for those requiring a constant current. Mode crossover occurs automatically. On the *HP E3610A*, range 1 is 8V/3A and range 2 is 15V/2A. The *HP E3611A*'s range 1 is 20V/1.5A and range 2 is 35V/0.85A.

For ease of use, the power supplies have separate digital displays for voltage and current readout, a CC-set button for setting the current level of the supply without having to short the output, and mode-indicator LED's to show whether the supply is in CV or CC mode.

The *HP E3610A* and *HP E3611A* each cost \$300.—**Hewlett-Packard Company**, 150 Green Pond Road, Rockaway, NJ 07866; Phone: 1-800-538-8787.

THERMAL-PRINTER CONTROLLER.

Designed for anyone who needs a small-printing format, **Computer Advice** has introduced a 5-volt, 2 1/4-inch-format high-speed thermal-printer controller. The device interfaces with the Seiko STP 211-192 Thermal Printhead and operates on five volts at less than one amp with serial interface active. The controller prints bi-directionally and includes either vertical or horizontal formats. The controller can be

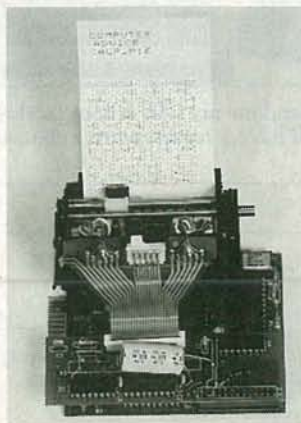

CIRCLE 21 ON FREE INFORMATION CARD

customized for each individual's use. In certain applications, it is capable of 250 words per minute.

The complete package consists of an 80C31 processor board, the printer controller board, a DB-25 serial-interface connector, and one package of thermal fanfold paper. The thermal printer is sold uncased for more versatility, and can be purchased with options such as a wall-mounted power supply and the Seiko Thermal Printhead.

The thermal printer controller costs \$145.—**Computer Advice**, 515 Calle San Pablo, Camarillo, CA 93012.

PIEZO SOUNDER.

A high-output piezo sounder from **International Components Corporation** is intended for use in automotive, marine, and other applications where there might be exposure to high temperatures. The model *BRP-4629P9-CS* has an operating range of -40° to



CIRCLE 22 ON FREE INFORMATION CARD

+120°C. It provides a continuous tone with trigger and its sound output rate at one meter is 2.8-kHz at 105 dB, for a clear warning sound. Its resonant frequency is 2500 ± 500 Hz, and its rated voltage is 9VDC.

The model *BRP-4629P9-CS* is priced starting at \$3.60 in production quantities.—**International Components Corporation**, 105 Maxess Road, Melville, NY 11747; Phone: 516-293-1500.

12-FUNCTION DIGITAL MULTIMETERS. The combination of large LCD readout, annunciators for all available ranges, and the number of available ranges make the DM25XL and DM27XL digital multimeters easy to use for most jobs, eliminating the need to carry around a case full of test instruments for different jobs. The two meters, from Beckman Industrial Corporation, provide 12 functions in one unit, and the annunciators lessen the chance of using the wrong range. Both units are 3½-digit,

0.8%-accuracy DMM's that feature 37 ranges, an audible continuity beeper, diode test, logic functions, and transistor hFE measurements. To conserve battery life, auto-off is also standard. The DM27XL adds to those functions a go/no-go test on LED's and includes the ability to measure frequency to 20 MHz, which is needed for servicing both telecommunications and computer equipment.

Both models include a built-in TTL logic probe that detects 20-ns pulses (2.4 volts high and 0.7 volts low). The two DMM's each have seven resistance ranges to 2000 megohms, five capacitance ranges to 20 µF, AC and DC current measurement to 10 amps, five VAC and five VDC ranges, and the ability to test diodes and measure transistor gain. The input impedance is 10 megohms.

The DM25XL and the

DM27XL digital multimeters have suggested retail prices of \$109 and \$129, respectively.—

Beckman Industrial Corporation, 3883 Ruffin Road, San Diego, CA 92123-1898; Phone: 619-495-3200.

PROTOTYPING SYSTEM. Providing a complete system for the development of embedded control applications, the R-535 prototyping board with R-Ware from Rigel Corporation features efficient software and on-board prototyping components in a single integrated unit that's designed to communicate with a PC acting as host. The R-535 uses the 80535 microcontroller, an enhanced version of the popular Intel 8032 controller, and can be used to develop programs for the entire 8031 family of microcontrollers.

The on-board ROM-

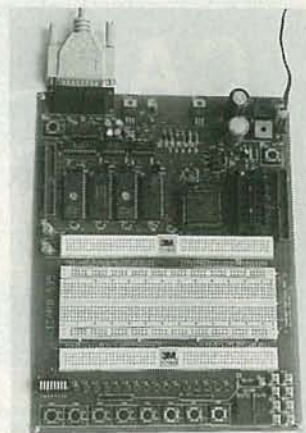

CIRCLE 24 ON FREE INFORMATION CARD

based software includes an operating system, a monitor system, EPROM burner software, and user-accessible system-calls for control and communication support. The host-based software is a menu-driven integrated environment with an editor, assembler, debugger, and PC-to-board communications.

The hardware consists of pushbuttons, dip switch-



CIRCLE 23 ON FREE INFORMATION CARD

HANDS-ON TECHNICAL SEMINARS FOR PROFESSIONALS

"Servicing the Video Laser Disc Player" - EIA / CEG

"Hot-Air Soldering Techniques" - Thomson Consumer Electronics

"Advanced Digital Circuitry - Digital TV" - Toshiba America, Inc.

**"Troubleshooting Tough VCR Mechanical and Electronic Problems" -
Tentel Corp. and Sencore, Inc.**

**"Microprocessor Controls - Troubleshooting Techniques Using the Mitsubishi
Wide-Screen Simulator" - Mitsubishi Electronics America**

Courses **FREE** when registered at the National Professional Electronics Convention
August 5-11, 1991; Nugget Resort, Reno NV.

Full \$230 Registration (at door) includes:

- All Technical Training Seminars (limited seating)
- All Management and Business Seminars
- Continuing Education units for all seminars attended
- Two Day Trade Show
- Head-to-head Meetings with Manufacturers' National Service Managers
- All Sponsored Meals and Functions
- NESDA / ISCET Association Meetings
- Price discounts available for pre-registration

Sponsored by the National Electronic Sales & Service Dealers Association
and the International Society of Certified Electronics Technicians

For more information, contact NPEC '91

2708 W. Berry St., Fort Worth, TX 76109-2356
(817) 921-9061; fax (817) 921-3741

CABLE - TV

SIGNAL REMOVERS

- FOR ELIMINATION OF SEVERE INTERFERENCE
- FOR "CENSORING" OF ADULT BROADCASTS



FOR FULL DESCRIPTION OF USES ask for our free brochure

- ATTENUATION - 45 dB TYPICAL
- BANDWIDTH - 4 MHz AT 5 dB POINTS
- INSERTION LOSS - 2 dB

MODEL	TUNING RANGE	FOR CHANNELS	PASSBAND	PRICE	SHIPPING
23H	50-66 MHz	2,3 (or 6 meter ham)	50-300 MHz	\$30	NO SHIPPING or C.O.D. CHARGES
46FM	66-108 MHz	4,5,6 (or any FM)	50-300 MHz	\$30	
1417	120-144 MHz	14(A) 15(B) 16 (C) 17(D)	50-400 MHz	\$30	
1822	144-174 MHz	18(E) 19(F) 20(G) 21(H) 22 (I)	50-400 MHz	\$30	
713	174-216 MHz	7,8,9,10,11,12,13	50-400 MHz	\$30	

3 for \$75 - 10 for \$200 - mix or match

CALL TOLL FREE FOR C.O.D. OR SEND CHECK TO ORDER
FAST DELIVERY
30 DAY MONEY BACK GUARANTEE (3 FILTER LIMIT)

Star Circuits

P. O. Box 94917
Las Vegas, NV 89193-4917

1-800-433-6319

es, LED's, numerical displays, and potentiometers for emulating control-application inputs and outputs. There are two solderless breadboard terminal strips, one connected to the prototyping components and the other to the microcontroller ports and control lines—plus a large solderless breadboard. That setup provides flexibility for connecting prototyping components to the microcontroller lines and for developing and debugging user-designed analog and digital application circuits.

The *R-535/R-Ware* package—including a 100-plus-page users guide with schematics, board layout, and control experiments with software examples—is available as a kit for \$395 or assembled and tested for \$495.—**Rigel Corporation**, P.O. Box 90040, Gainesville, FL 32607.

include dual time base, push-button switch selection with vertical and horizontal mode "select" for fast setup and readout, and an easy-to-read front-panel layout. In addition, the *P2840* offers a memory function and cursor readouts to indicate time, amplitude, frequency, duty cycle, and phase shift.

The *P2840* digital storage oscilloscope costs \$1630.—**Protek**, P.O. Box 59, Norwood, NJ 07648; Phone: 201-767-7242; Fax: 201-767-7343.

PORTABLE AUDIO GENERATOR. Designed for the audio professional, *Forward Innovations'*



CIRCLE 26 ON FREE INFORMATION CARD

PAG-1 hand-held portable audio generator provides a versatile means for checking sound systems. The generator has a variable output up to 1 volt and is DC decoupled so that it can be used to measure impedance. It can also be used to check capacitance and inductance. The *PAG-1* boasts a THD of less than 0.03% and it sweeps from 18 Hz to 22.5 kHz in three continuous overlapping ranges. The dial is marked in 1/3-octave segments for easy check out. It runs on a 9-volt battery and is protected to 50 volts DC or 30 volts AC.

The *PAG-1* portable audio generator is \$139.—**Forward Innovations**, P.O. Box 9429, Santa Rosa, CA 95405. **R-E**

DIGITAL STORAGE OSCILLOSCOPE. Featured functions in the *Protek Model P2840* DSO are 20-megasample per second (Ms/s) sampling and "Vu-Write" cursor CRT readouts. In addition, the 40-MHz real-time DSO deliv-



CIRCLE 25 ON FREE INFORMATION CARD

ers a vertical resolution of 256 dots, a horizontal resolution of 1024 dots, indicating memory of 2048 words, reference memory with storage of up to four signals, and an 8-MHz effective storage frequency. Pre/post trigger is at 25% and 75%, and there are a variety of rear panel interconnects for extended use. Key analog functions



An ETCHED circuit board from a Printed PAGE in just 3 Hours

The ER-4 PHOTO ETCH KIT gives you the tools, materials and chemicals to make your own printed circuit boards. The patented Pos-Neg™ process copies artwork from magazines like this one without damaging the page. Use the circuit patterns, tapes and drafting film to make your own 1X artwork. Or try the Direct Etch™ system (also included), to make single circuit boards without artwork. The ER-4 is stocked by many electronic parts distributors, or order direct, postpaid.

ER-4 PHOTO ETCH KIT (NJ and CA residents add sales tax) . . . \$38.00
DATAK'S COMPLETE CATALOG lists hundreds of printed circuit products and art patterns. Also contains dry transfer letter sheets and electronic title sets for professional looking control panels. **WRITE FOR IT NOW!**

DATAK Corporation • 55 Freeport Blvd, Unit 23 • Sparks, NV 89431

CIRCLE 176 ON FREE INFORMATION CARD

NEW LIT

Use The Free Information Card for fast response.

RF DEVICE DATA: VOLUMES I and II; from Motorola, Inc., Literature distribution Center, P.O. Box 20924, Phoenix, AZ 85063; Phone: 602-994-6561.

This two-volume set represents the latest and most

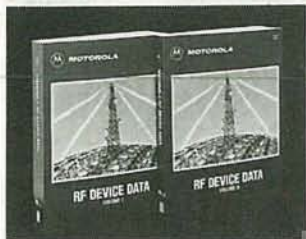

CIRCLE 40 ON FREE INFORMATION CARD

complete listing of standard products offered by the RF Products Division of Motorola Semiconductor. The set lists complete data for all RF products in Motorola's portfolio, including power FET's, power bipolar, small-signal, and modules. Data sheets on 84 new products are included, as well as additional items in the applications section.

HOMEWORKS BY HEATHKIT; from Heath Company, Department 350-055, Benton Harbor, MI 49022; Phone: 1-800-44-HEATH; free.

The cover story of Heathkit's Spring 1991 catalog is an 8-bit microprocessor trainer in kit form. The practical learning tool, used to perform experiments for Heath courses, is specially designed to improve understanding of 8-bit microprocessor operation, programming, and applications. The trainer can be used with many of the



CIRCLE 39 ON FREE INFORMATION CARD

latest 8-bit microprocessors simply by switching plug-in modules. An RS-232 interface lets the trainer be used with a terminal, and a built-in sonic logic probe lets the user check high, low, or pulse signals both visually and audibly.

The 40-page catalog also introduces four new home-study video courses on component recognition, soldering, digital techniques, and microprocessors. The video courses are condensed, home-study versions of VHS tapes formerly used in university classrooms. Also featured are courses in basic and advanced electronics, laser technology, electro-optics, surface mount technology, and amateur radio; and a variety of innovative educational kits for both beginning and experienced kit builders.

THERE ARE NO ELECTRONS: ELECTRONICS FOR EARTHLINGS; by Kenn Amdahl. Clearwater Publishing Company, Inc., Scenic Heights Professional Building, P.O. Box 1153, Arvada, CO 80001-1153;

Phone: 303-42206725; \$12.95.

We'll assume, since you're reading **Radio-Electronics**, that you understand electricity. (But then, we thought we did, too, until we began reading this book.) A bizarre cross between *Grimms's Fairy Tales* and Richard Brautigan's *Trout Fishing in America*, with a hefty dose of 1960's imagery and slang thrown in, the book takes a totally irreverent look at some pretty serious stuff. If your career revolves around the understanding of electricity, and you have years of higher education in that field, you might have little patience for this book. But if you believe that one prerequisite to a happy, healthy life is the ability to laugh at yourself, read it. And if any of you have ever tried to explain electricity to spouses, children, friends, or parents, only to see their eyes glaze over after a minute or two, this book could do the trick.

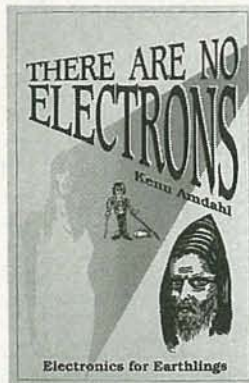

CIRCLE 38 ON FREE INFORMATION CARD

Although the author claims to base his work on the dual premises that "No one really understands electricity" and "No one wants to admit it," he does

a commendable job of furthering the general understanding of electricity in a unique style. And, although he warns that analogies ("electricity is like water flowing through a pipe") are imperfect models that can be dangerous when taken as representations of reality, he has created some of the most unusual analogies we've ever come across. Not only is there no chance of these models being taken as reality, there's also little chance that anyone who reads them will ever forget them.

Somehow, between the laughs, a real understanding of electricity unobtrusively takes hold.

CASE CATALOG; from Jensen Tools, Inc., 7815 South 46th Street, Phoenix, AZ 85044; Phone: 602-968-6231; free.



CIRCLE 37 ON FREE INFORMATION CARD

The 32 illustrated pages in this catalog describe transport products for electronic engineers and field-service technicians. Included are hard- and soft-sided, rugged-duty, and attache-style cases in all sizes for carrying tools, PC boards, test instruments, and other electronic service equipment. The color catalog also features airline shipping containers, and describes Jensen's custom-case and custom-tool-kit design services.

PARTS PLACESM

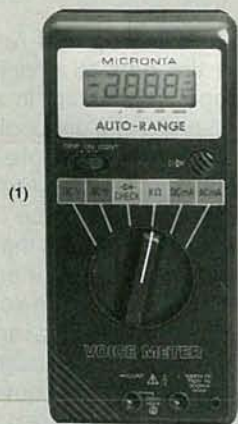

(1)

(1) **Talking Multimeter.** Timesaving *speech* output! Press a button on the probe and this meter calls out the reading in clear English while displaying it. Features include full autoranging, liquid crystal display with low-battery and over-range indicators, continuity beeper, diode-check mode. #22-164 99.95

(2) **NEW! Building Power Supplies.** Easy-to-understand, 96-page book explains linear and switching supplies. Includes complete plans for building five useful supplies with Radio Shack parts. #276-5025, 4.95

(3) **Mini Audio Amplifier.** Great for computer voice/music synthesis, signal tracing and more. Has a built-in speaker, 1/8" headphone jack, 1/8" input jack and volume control. #277-1008 11.95

(4) **Digital Logic Probe.** LEDs and tone outputs reveal logic states instantly. It's the fast way to check operation and pinpoint problems in all types of digital circuits. #22-303 16.95



(2)



(3)



(4)

Parts Special-Order Hotline. Your local Radio Shack store stocks over 1000 popular electronic components. Plus, we can special-order over 10,000 items from our warehouse—linear and digital ICs, transistors and diodes, vacuum tubes, crystals, phono cartridges and styli, even SAMS® service manuals. Your order is sent directly to your Radio Shack store and we notify you when it arrives. Delivery time for most items is one week and there are no postage charges or minimum order requirements.

(1) **Shielded RS-232 Jumper Box.** Top-quality inline D-sub 25 adapter. Wire the included jumper wires and board to suit your need. #276-1403 9.95

(2) **RS-232 Tester.** Dual-color LEDs monitor seven data/control lines to help you spot problems quickly. D-sub 25. Connects inline. #276-1401 14.95

(3) **Grounded-Tip Soldering Iron.** 15W. #64-2051 7.49

(4) **Vacuum-Type Desoldering Tool.** #64-2120 6.95

(5) **Locking Forceps.** 6" long. Stainless. #64-1866 4.95

(6) **Rosin Soldering Paste Flux.** #64-021 1.79

(7) **Lead-Free Solder.** 0.25 oz. #64-025 1.99

Over 100 soldering items and tools for electronics work are in stock at Radio Shack!

(8) **10A Microwave Oven Fuses.** #270-1256 Pkg. of 2/1.29

(9) **2-Amp Fast-Acting Fuses.** #270-1275 Pkg. of 3/79¢

(10) **5-Amp "Blade" Car Fuses.** #270-1205 Pkg. of 2/89¢

Big selection of fuses, holders and accessories in stock!

Computer/Business Machine AC Power Cords. 6 feet long.

(11) **Extension.** #278-1259 4.99

(12) **With Space-Saving 90° CEE Connector.** #278-1260 5.99

(13) **With Straight CEE Connector.** #278-1257 3.99

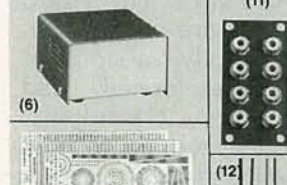
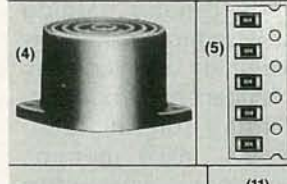
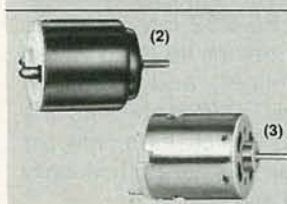
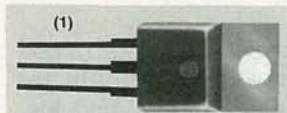
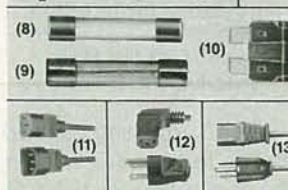
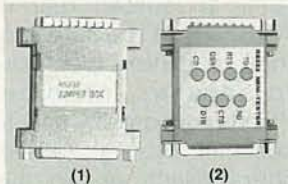

(1) **Voltage Regulator ICs.** Feature built-in overload protection and thermal shutdown. Maximum input: 35VDC.
7805. 5V. #276-1770 1.19
7812. 12V. #276-1771 1.19

(2) **Low-Voltage Motor.** Just the thing for science projects, robotics and solar power demos. Operates 1 1/2 to 3VDC. About 1 1/2" long. #273-223 99¢

(3) **High-Speed 12VDC Motor.** Up to 15,200 RPM, no load. About 2" long. #273-255 2.99

(4) **"Ding-Dong" Chime.** This IC and mini-speaker combo is ideal for a customer-entry alert or doorbell. Produces 80 dB sound pressure at 12 VDC. Operates 6 to 18 VDC. #273-071 8.99

(5) **Surface-Mount Resistors.** 200-piece assortment of 15 popular values. Rated 1/8 watt, 5%. #271-313 Set 4.99

Radio Shack Has 20 different project enclosures in stock!

(6) **Metal Project Cabinet.** An attractive, easy-to-drill housing at a low price. 3 x 5 1/4 x 5 7/8". #270-253 6.79

(7) **Project Labels.** Four sheets of rub-on letters, numerals and callibrations. #270-201 2.99

(8) **Power Supply Case.** Vented 2 1/2 x 4 5/8 x 3 1/4" molded case. #270-287 3.99

(9) **0 to 15 DC Voltmeter.** Panel-mount. #270-1754 7.95

(10) **Box/Board Combo.** Molded enclosure plus predrilled 2 x 3 1/8" board, labels and more. #270-291 4.99

(11) **Eight-Position Phono Jack Board.** #274-370 1.39

(12) **1:1 Audio Transformer.** Z: 600-900Ω. #273-1374 3.59

(13) **Three-Pin XLR Mike Plug.** Metal body. #274-010 2.99

(14) **Three-Pin XLR Mike Inline Socket.** #274-011 2.99

(15) **Three-Pin XLR Mike Panel Socket.** #274-013 3.69

ELECTROCARDIOGRAPH

IF YOU'RE INTERESTED IN MEDICAL ELECTRONICS, OR just concerned about your family's health, then you should build the Radio-Electronics electrocardiograph. The electrocardiograms (ECG's or EKG's) it will produce can be analyzed by yourself or your doctor. We are not suggesting that you practice medicine using this device, but you should find it interesting and educational in monitoring your health. You will see some of the unique techniques used in medical electronics and you may be surprised to see how similar medical electronic equipment is to most other types of electronic equipment.

The electrocardiograph that we will build produces ECG's that are essentially identical to those produced by commercial machines costing \$10,000 dollars or more. In order to keep our cost to a minimum we use a standard PC as an operator interface and output device. That way you can print out a hard copy of your ECG or just display it on your monitor.

Biological theory

In order to understand the electronic operation of an electrocardiograph, we need to understand some basic biological principles. As shown in Fig. 1, the heart consists of four chambers which are organized as two pumps—the so-called right and left heart. The right heart collects the blood returning from the body and pumps it to the lungs, while the left heart collects blood from the lungs and pumps it to the body.

Each pump has two parts: the upper chamber known as the atrium and the lower chamber known as the ventricle. The atrium collects blood between cycles and at the appropriate time contracts, filling the lower ventricles. The ventricles then contract and pump blood to the lungs or body.

The heart is controlled by a pulse generator, known as the pacemaker, located in the right atrium, which initiates cardiac action. It is analogous to the clock in a digital system. The pulse it generates is first sent to both atrium which causes them to contract, filling the ventricles. After a delay of approximately 150 milliseconds, the ventricles are then triggered by the same pulse, which causes them to contract. As in a digital system, the timing relationships are quite important and much of the disease associated with the heart is related to timing defects.

Figure 2 shows a typical signal as seen on an ECG. The first pulse, called the "P" wave, is generated by the pacemaker. The next pulse, called the "QRS complex," represents the electrical signal generated by the ventricles contracting. The "T wave" which follows the QRS complex is generated as the muscles of the ventricles relax, or repolarize.

A standard ECG consist of 12 channels; each channel "looks" at the heart from a different electrical axis. The different "views" allow us to interpret the activity of different parts of the heart. The timing relationships between different components of the heart will identify defects in the conduction pathways.

How ECG's are used

In patients with high blood pressure, the left ventricle will become quite large due to its in-

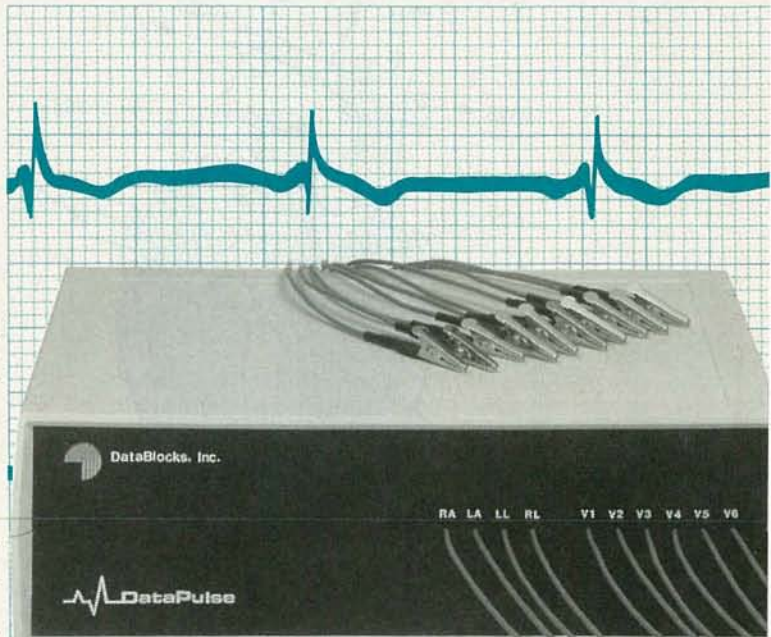

Keep an eye on your health and learn about medical electronics with the Radio-Electronics electrocardiograph.

H. EDWARD ROBERTS, M.D.

WARNING!! This article deals with and involves subject matter and the use of materials and substances that may be hazardous to health and life. Do not attempt to implement or use the information contained herein unless you are experienced and skilled with respect to such subject matter, materials and substances.

Furthermore, the information contained in this article is being provided solely to readers for educational purposes. Nothing contained herein suggests that the monitoring system described herein can be or should be used by the assembler or anyone else in place of or as an adjunct to professional medical treatment or advice. Neither the publisher nor the author make any representations as for the completeness or the accuracy of the information contained herein and disclaim any liability for damages or injuries, whether caused by or arising from the lack of completeness, inaccuracies of the information, misinterpretations of the directions, misapplication of the information or otherwise.

JULY 1991

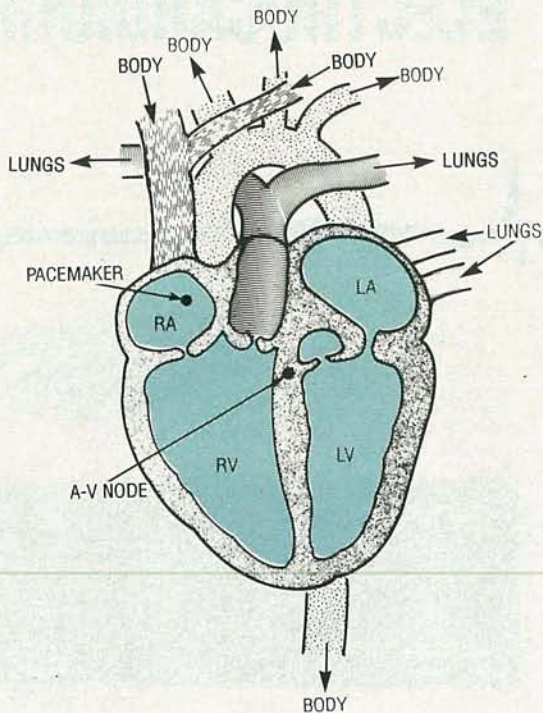

FIG. 1—THE HEART CONSISTS OF FOUR CHAMBERS which are organized as two pumps, known as the right and left heart. The right heart collects the blood returning from the body and pumps it to the lungs, while the left heart collects blood from the lungs and pumps it to the body.

TABLE 1—I/O PORT ADDRESS FUNCTIONS

Port Address	Control Pulse Function
52	Generates Clock for Multiplexer Sequencer
53	Generates Clear for Multiplexer Sequencer
54	Latches ECG Control Signal Byte in IC16
55	Latches Lead Offset Data in IC17

creased work load. That is seen as a significant increase in the amplitude of the QRS complex. Treatment of the high blood pressure will allow the left ventricle to return to normal size, which significantly decreases the chance of a heart attack.

Since the amplitude of the electrical signals in the heart are a function of chemicals in the body, it is possible to predict abnormalities. For example, an elevated potassium level will produce a tall peaked T wave.

If a portion of the ventricle is damaged, a so-called "Q wave" is formed which is simply a negative-going QRS complex. The location of the damage can be determined by noting which leads contain the Q wave. That's how a doctor can tell where you have had a heart attack.

Most normal individuals pro-

duce an extra, or irregular heart beat every now and then, which may occur in the top or bottom of the heart. It is a condition known as arrhythmias. The irregular beats can be quite dangerous if they occur frequently or if they occur during certain intervals in the normal cardiac cycle. Many researchers believe that the most common cause of death in males is due to irregular beats occurring at a time such that they "scramble" the normal electrical timing in the heart—the situation is known as fibrillation.

Special ECG systems, known as Holter monitors, can detect these irregular beats. They are simply ECG's with one or more channels that store each of the 80,000 or so beats in one day. The data from the Holter is then fed into a computer which analyzes it for arrhythmias. Similar

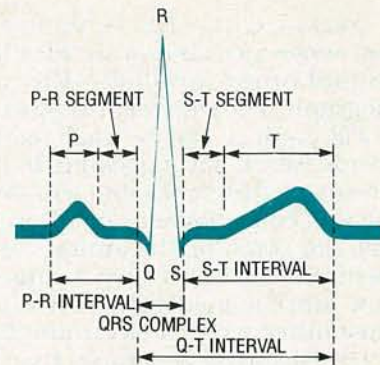

FIG. 2—A TYPICAL SIGNAL as seen on an ECG. The first pulse, called the "P" wave, is generated by the pacemaker. The next pulse, called the "QRS complex," represents the electrical signal generated by the ventricles contracting. The "T wave" which follows the QRS complex is generated as the muscles of the ventricles relax, or repolarize.

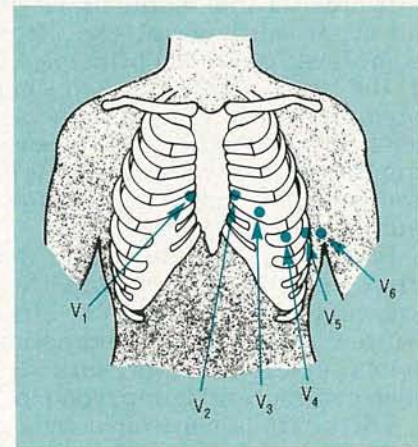

FIG. 3—TEN LEADS ARE CONNECTED to the patient in a 12-channel system; they are right arm, left arm, left leg, and 6 chest leads called the V leads. The right leg is used as a ground and as an input to reduce system noise.

monitoring equipment is used in ambulances and intensive care units for instantaneous analysis of irregular beats. Often this analysis is performed automatically by arrhythmia detectors.

Another area of particular interest in ECG's is the "ST segment." That is the area between the QRS and the T wave. It is very predictive of obstructed arteries before any damage occurs to the heart. Obstruction of an artery will result in a depressed ST segment of the ECG—it will fall below the base line in the affected leads. The exercise cardiogram, or stress test, looks primarily at the ST portion of the ECG to predict if any of the heart's arteries are becoming clogged.

It is possible to become quite

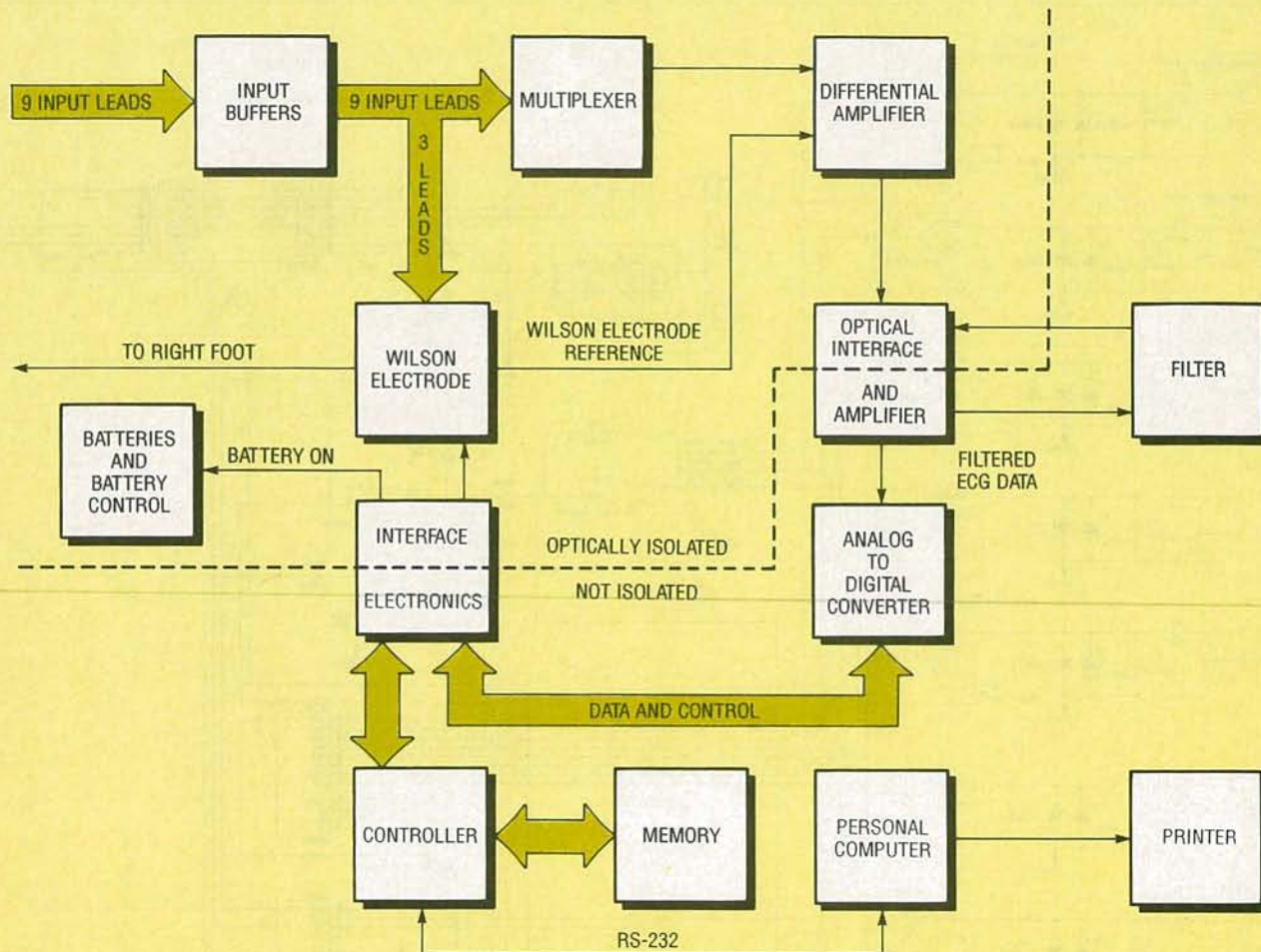

FIG. 4—BLOCK DIAGRAM OF THE COMPLETE ECG SYSTEM. The system logically divides into the front-end electronics and the controller. Data communication between the analog and digital portion of the ECG is accomplished through optical isolators, which helps keep the patient isolated.

All resistors are 1/4-watt, 5%, unless otherwise noted.

R1—10 ohms
R2, R7—R10—10,000 ohms
R3—R6, R15, R16—1000 ohms
R11—7500 ohms
R12—24,000 ohms
R13—30,000 ohms
R14—10,000 ohms × 8, SIP

Capacitors

C1—C22, C25, C26, C28, C29, C33, C34,
C42—0.47 μF, ceramic disk
C23, C24—22 pF, ceramic disk
C27, C30—0.001 μF, metal film
C31—220 pF, ceramic disk
C32—10 μF, 10 volts, electrolytic
C35, C38, C39,—10 μF, 10 volts,
tantalum
C36, C37, C40, C41—1 μF, 10 volts,
tantalum

Semiconductors

IC1—Z80 CPU
IC2—IC5, IC12—74HC245 bus
transceiver
IC6, IC8—Altera EP320 PAL
IC7—Altera EP600 PAL
IC9—27C256 EPROM
IC10, IC11—55257 static RAM
IC13—74HC688 equality comparator

PARTS LIST—CONTROLLER

IC14—74HC138 1-of-8 decoder
IC15—82C52 UART
IC16, IC17—74HC573 octal latch
IC18—74HC74 dual D flip-flop
IC19—MC145406 RS232 transceiver
IC20—AD0829 A/D converter
IC21, IC22—DAC0830 D/A converter
IC23, IC24—NE5532A op-amp
IC25—74HC14 hex Schmitt inverter
IC26—74HC00 quad NAND gate
IC27—PS2501A-2 optoisolator
IC28, IC31—not used
IC29—ICL7660 DC-DC converter
IC30—78L06AC voltage regulator
IC32—7805 voltage regulator
D1—D4—1N914 diode
D5—5.1-volt Zener diode
D6—6-volt Zener diode
Q1—IRFZ10 N-channel MOSFET
Other components
XTAL1—2.4576 MHz crystal
XTAL2—8.00 MHz oscillator
S1—SPDT momentary contact switch
SO1—DB25 connector

Note: The following items are available from DataBlocks, Inc., Glenwood, GA 30428, (912) 568-7101.

- Design package including sche-

atics, assembly instructions, and checkout- and plot-software design specifications (ECG-DP): \$27.00.

- Front-end PC board, controller PC board, and design package from above (ECG-PC): \$74.00.

- Complete kit of parts, including both PC boards, IC's, sockets, passive components, design package, ECG software, and checkout software (ECG-KIT): \$289.00.

- Lead kit consisting of 50 feet of 29-gauge shielded cable, 10 alligator clips, heat-shrink tubing, and instructions (ECG-LD): \$53.00.

- EPROM containing ECG software, ECG resident portion of checkout software (ECG-PROG): \$45.00.
- Set of four programmed PAL's (ECG-PAL): \$67.00.

- Case as shown with mounting hardware (ECG-CASE): \$29.00

- Package of 100 self-adhesive electrodes (ECG-EL): \$20.00.

Please include \$5.00 shipping and handling for design package and electrodes, \$10.00 shipping and handling for all other products. Georgia residents must add sales tax.

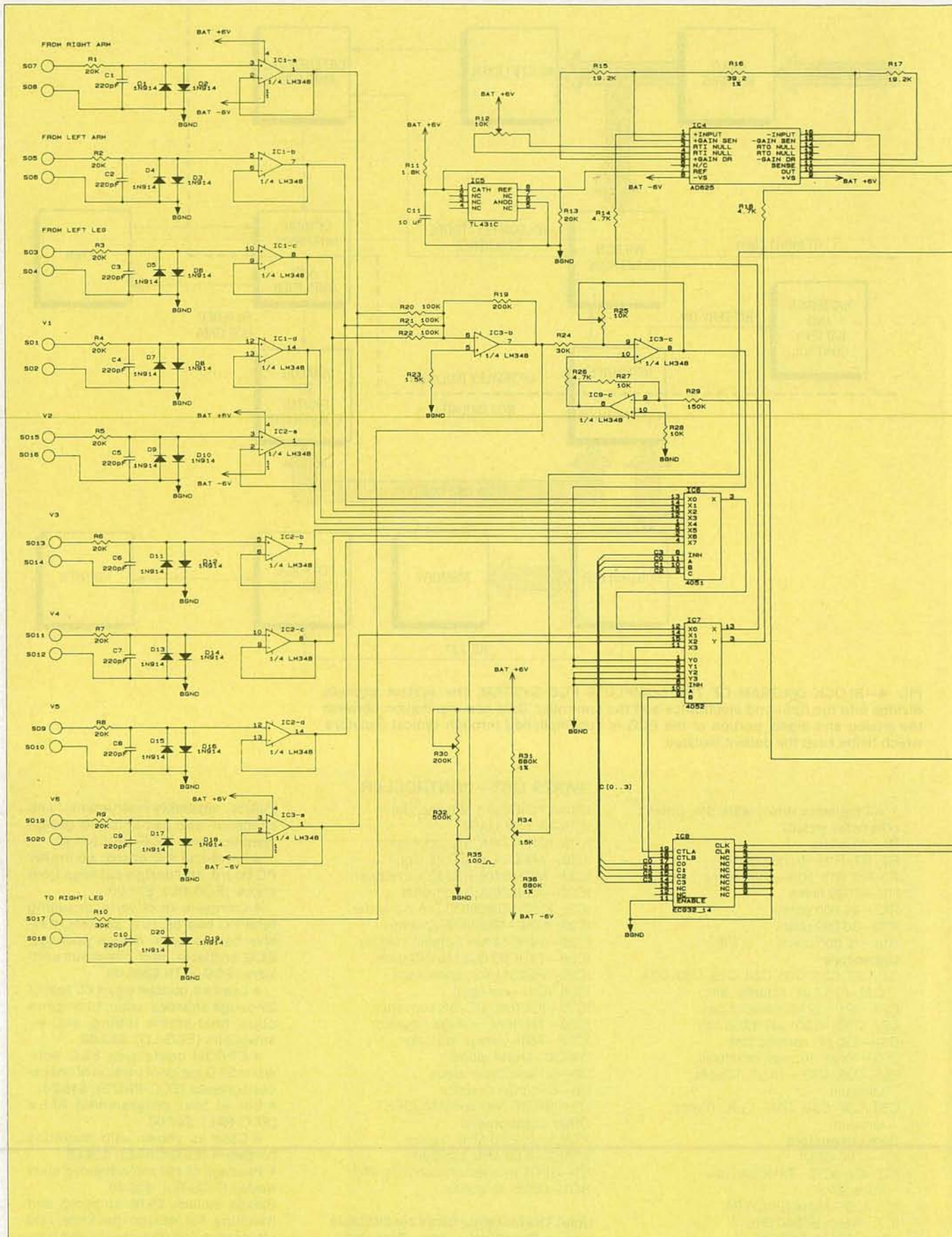
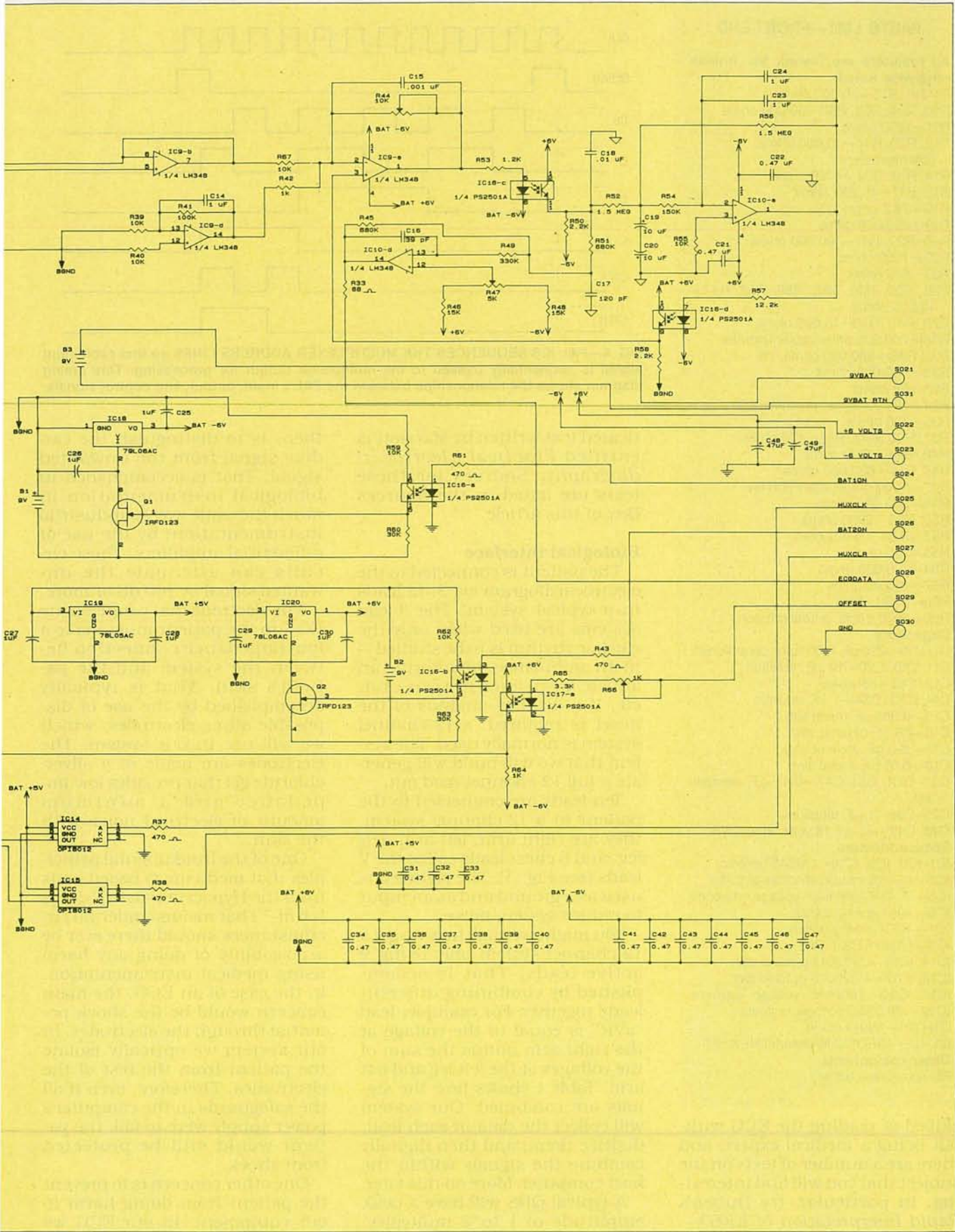

FIG. 5—THE FRONT-END ELECTRONICS takes in the signals from the 9 input leads located on the patient. The small signal from each of the leads is fed into the quad op amps IC1, IC2, and IC3-a.



PARTS LIST—FRONT-END

All resistors are 1/4-watt, 5%, unless otherwise noted.

R1-R9, R13—20,000 ohms
 R10, R24, R60, R63—30,000 ohms
 R11—1800 ohms
 R12, R25, R44—10,000 ohms, potentiometer
 R14, R18, R26—4700 ohms
 R15, R17—19,200 ohms
 R16—39.2 ohms, 1%
 R19—200,000 ohms
 R20-R22, R41—100,000 ohms
 R23—1500 ohms
 R27—910 ohms
 R28, R39, R40, R55, R59, R62, R67—10,000 ohms
 R29, R46, R48—15,000 ohms
 R30—200,000 ohms, potentiometer
 R31, R36—680,000 ohms, 1%
 R32—500,000 ohms
 R33—68 ohms
 R34—15,000 ohms, potentiometer
 R35—100 ohms
 R37, R38, R43, R61—470 ohms
 R42, R64—1000 ohms
 R45, R51—680,000 ohms
 R47—5000 ohms, potentiometer
 R49—330,000 ohms
 R50, R58—2200 ohms
 R52, R56—1.5 megohm
 R53—150 ohms
 R54—150,000 ohms
 R57—12,200 ohms
 R65—3300 ohms
 R66—1000 ohms, potentiometer

Capacitors
 C1-C10—220 pF, 1000 volts, ceramic disk
 C11, C19, C20—10 μ F, tantalum
 C12, C13—not used
 C14, C23, C24—1 μ F, ceramic
 C15—0.001 μ F, metal film
 C16—39 pF, ceramic disk
 C17—120 pF, ceramic disk
 C18—0.01 μ F, metal film
 C21, C22, C31-C47—0.47 μ F, ceramic disk
 C25-C30—1 μ F, tantalum
 C48, C49—47 μ F, 16 volts, electrolytic

Semiconductors
 IC1-IC3, IC9, IC10—LM348 op-amp
 IC4—AD625 instrumentation amplifier
 IC5—TL431C precision voltage reference
 IC6—4051 analog switch
 IC7—4052 analog switch
 IC8—Altera EP320 PAL
 IC14, IC15—OP18012 optoisolator
 IC16, IC17—PS2501A optoisolator
 IC18, IC20—78L06AC voltage regulator
 IC19—78L05AC voltage regulator
 D1-D20—1N914 diode
 Q1, Q2—IRFD123 N-channel HEXFET

Other components
 B1-B3—9-volt battery

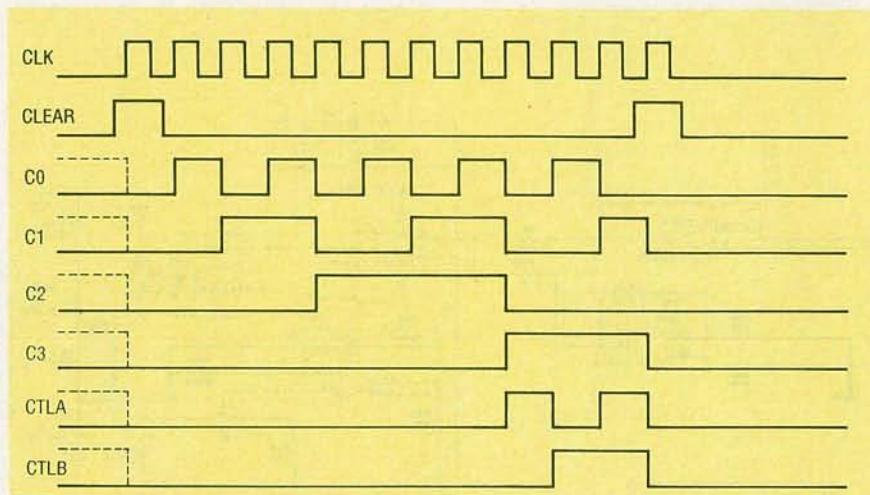

FIG. 6—PAL IC8 SEQUENCES THE MULTIPLEXER ADDRESS LINES so that each input signal is sequentially passed to the multiplexer output for processing. This timing diagram shows the relationships between the PAL's input, output, and control signals.

ticated text written by Marriott is entitled *Practical Electrocardiography*. Sources for these texts are listed in the Sources Box of this article.

Biological interface

The patient is connected to the electrocardiogram via 3-12 leads in a typical system. The 3-lead systems are used when only the cardiac rhythm is to be studied—in an ambulance, monitoring an athlete, in an intensive care unit, etc. If a detailed analysis of the heart is required, a 12-channel system is normally used. The system that we will build will generate a full 12-channel read out.

Ten leads are connected to the patient in a 12-channel system: they are right arm, left arm, left leg, and 6 chest leads called the V leads (see Fig. 3). The right leg is used as a ground and as an input to reduce system noise.

You might well ask how we get a 12-channel system only using 9 active leads. That is accomplished by combining different leads together. For example, lead "aVR" is equal to the voltage at the right arm minus the sum of the voltages at the left leg and left arm. Table 1 shows how the signals are combined. Our system will collect the data in each lead, digitize them, and then digitally combine the signals within the host computer. More on this later.

A typical QRS will have a peak amplitude of 1 to 2 millivolts. That may mix with noise (60-Hz hum, for example) with much higher amplitudes. The problem,

then, is to distinguish the cardiac signal from the unwanted signal. That is accomplished in biological instrumentation in much the same way as industrial instrumentation: by the use of differential amplifiers. These circuits can attenuate the unwanted signal by 100 dB or more.

The electrode that connects the ECG to the patient must make a low-impedance connection between the system and the patient's skin. That is typically accomplished by the use of disposable silver electrodes, which we will use in our system. The electrodes are made of a silver-chloride gel that provides low impedance and a minimum amount of electrical noise with the skin.

One of the fundamental principles that medicine is based on is from the Hypocrites Oath, "do no harm." That means under no circumstances should there ever be a possibility of doing any harm using medical instrumentation. In the case of an ECG, the main concern would be the shock potential through the electrodes. In our system we optically isolate the patient from the rest of the electronics. Therefore, even if all the safeguards in the computer's power supply were to fail, the patient would still be protected from shock.

One other concern is to prevent the patient from doing harm to our equipment. In our ECG we provide a resistor-diode network on each lead which prevents a high voltage from entering the

skilled at reading the ECG without being a medical expert, and there are a number of texts on the subject that you will find interesting. In particular, try Duben's *Rapid Interpretation of EKG's*—with it, you can become fairly knowledgeable of ECG's in a matter of a few hours. A more sophis-

ADDRESS FROM PAL				CONTROL FROM PAL		MULTIPLEXER STATE	
C3	C2	C1	C0	CTLB	CTLA	IC 6 IN → OUT	IC 7 IN → OUT
0	0	0	0	0	0	X0 → X	X0 → X Y0 → Y
0	0	0	1	0	0	X1 → X	X0 → X Y0 → Y
0	0	1	0	0	0	X2 → X	X0 → X Y0 → Y
0	0	1	1	0	0	X3 → X	X0 → X Y0 → Y
0	1	0	0	0	0	X4 → X	X0 → X Y0 → Y
0	1	0	1	0	0	X5 → X	X0 → X Y0 → Y
0	1	1	0	0	0	X6 → X	X0 → X Y0 → Y
0	1	1	1	0	0	X7 → X	X0 → X Y0 → Y
1	0	0	0	0	1	Z	X1 → X Y1 → Y
1	0	0	1	1	0	Z	X2 → X Y2 → Y
1	0	1	0	1	1	Z	X3 → X Y3 → Y

NOTE: Z = OUTPUT IN HIGH IMPEDANCE STATE

FIG. 7—MULTIPLEXER TRUTH TABLE shows how the signals from the PAL are used to control the sequencing of the input signals to the input of the instrumentation amplifier.

front-end amplifiers. An example where this might be significant would be in the case where a patient is "shocked," or defibrillated, after a cardiac arrest. In that case up to 400 volts could appear across the electrodes coming from the patient.

Now that we have a basic understanding of the underlying biological principles associated with the ECG, let's look at some of the technical details of the machine which we will construct. Then let's build one!

System Theory of Operation

A block diagram of the complete ECG system is shown in Fig. 4. The system can be divided into the front-end electronics and the controller. The analog portion attaches to the patient with 10 lead wires; 9 input leads, and 1 output, or reference lead. The analog portion of the ECG is powered by two 9-volt batteries to isolate the patient from any potentially dangerous power circuitry. In addition, data communication between the analog and digital portion of the ECG is accomplished through optical isolators, which also helps keep the patient isolated.

The controller section of the system contains a Z-80 based computer with 32K of RAM and 32K of EPROM. The controller section of the ECG also contains the analog-to-digital (A/D) conversion circuitry to convert the patient's analog ECG signals to the digital data required for computer processing. In addition, this section generates control signals to sequence the A/D conversion, compensate for input channel offset, and control the

input-lead multiplexer.

Notice that we have included a personal computer and printer in the diagram. Although not a part of this construction article, they are an integral part of the system since they provide the display for the ECG traces.

Front-end electronics

As previously discussed, the 12-trace ECG is derived from 9 input leads located on the patient. The small (approximately 1 millivolt) signal from each of the leads is fed into the quad op-amps IC1, IC2, and IC3-a, as shown in the schematic of Fig. 5.

The op-amps are configured as non-inverting, unity-gain amplifiers. They provide a very high input impedance that prevents the signals from the body electrodes from being loaded down. Notice also that the input to each amplifier circuit is shunted to ground by a 220-pF capacitor (C1-C10) and two diodes (D1-D20) in parallel. Those components are used to protect the input of the amplifier from the high voltages present during cardiac defibrillation, and to provide patient protection in the unlikely event that high voltage should feed back through the amplifier.

The output of the three limb leads from IC1-a, IC1-b and IC1-c are summed into op-amp IC3-b, inverted, and fed back to the patient through the 10th lead which is attached to the patient's right leg. The composite signal from the three limb leads is called the Wilson Electrode. The Wilson Electrode signal significantly reduces the common-mode noise in the system, since unwanted signals common to the three limb

leads are fed back to the patient 180 degrees out of phase with the original noise. The signal from the Wilson Electrode is again inverted in op-amp IC3-c and routed to the multiplexer to eventually form the reference against which the nine input signals are compared.

The multiplexer is made up of two integrated circuits, IC6 and IC7, in conjunction with the multiplexer-controller IC8. Analog-switch IC6 has 8 inputs (X0-X7). One of the eight inputs is connected through a very-low-impedance path to the output (X) according to the 3-bit address appearing on the control inputs C0-C2. For example, X0 is connected to X when the control address is 000, X1 is connected to the output when the control address is 001, and so on. The additional control address C3, is an inhibit which, when high, causes the output X to be a high impedance, effectively turning off the eight input signals to the multiplexer chip. The output of IC6 is routed to one of the inputs to IC7.

Another analog switch, IC7, has 2 outputs and 4 X-Y input pairs (X0-X3 and Y0-Y3). The X0 input is the output from IC6. The corresponding input Y0 comes from the Wilson Electrode, IC3-c. The signal from IC3-a (input 9) is the input to X1. The Wilson Electrode signal is also paired with input 9 on Y1. In addition to the the nine signal inputs from the patient, a 1-mV test signal and a ground input are routed to the X2 and X3 inputs respectively. Ground is the Y2 input for the corresponding 1-mV signal pair as well as for the X3 ground input on Y3.

Two address lines, CTLA and CTLB control which input pair is switched to the outputs. That is, when the control address is 0, inputs X0 and Y0 are switched to outputs X and Y respectively. These control lines as well as the control signals for IC6 are derived from the outputs of IC8.

IC8 is a programmable array logic (PAL) IC which sequences the multiplexer address lines so that each input signal is sequentially passed to the multiplexer output for processing. The PAL is programmed to advance the address on control lines C0 through

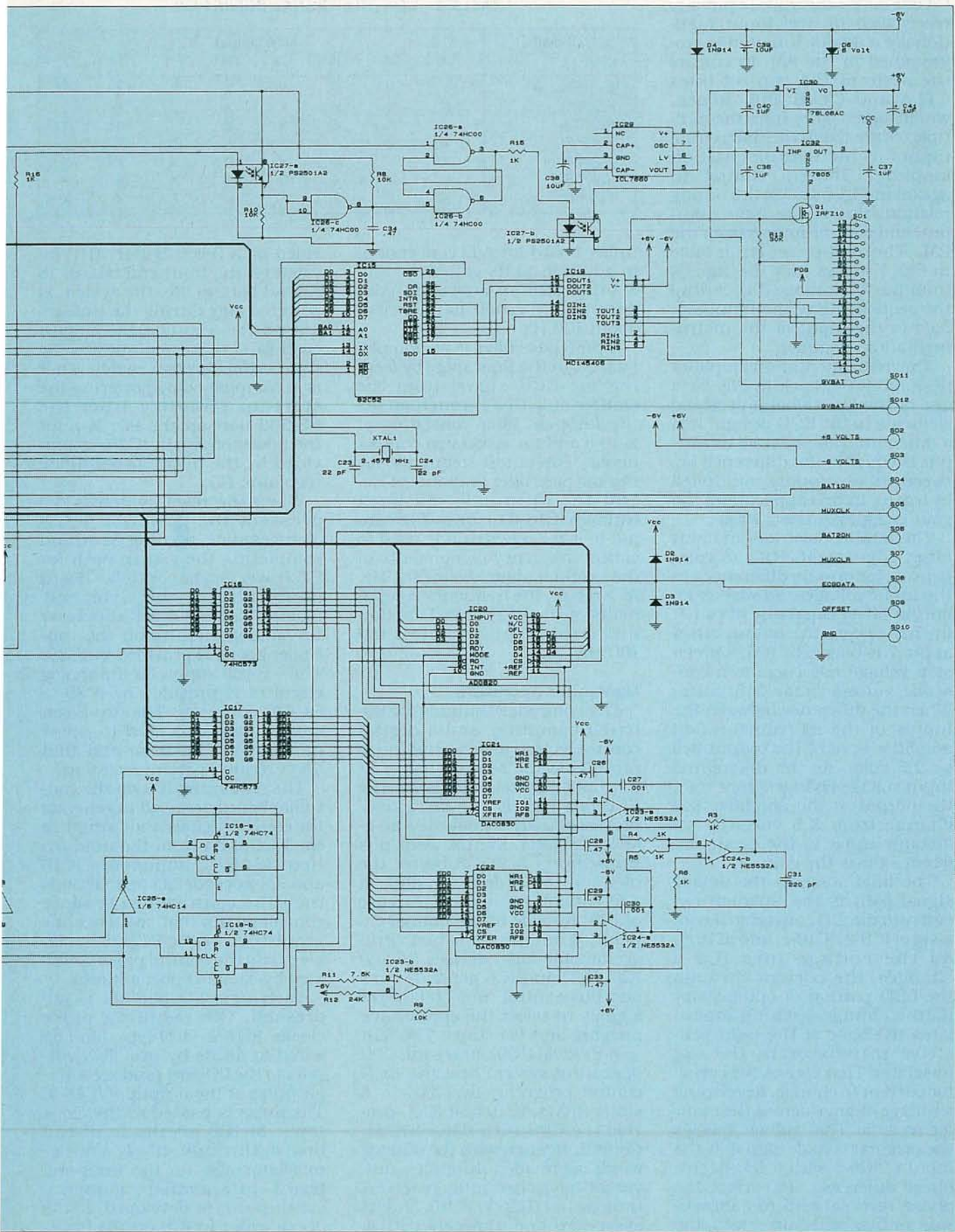

C3 one count each time a pulse is received on the clock input. Additionally, a decode function is programmed in the PAL to control the state of the control lines CTLA and CTLB and, hence, which signal pairs from the multiplexer are fed to the differential inputs of the instrumentation amplifier. The PAL timing diagram in Fig. 6 shows the timing relationships of the input, output, and control signals from the PAL. The multiplexer truth table in Fig. 7 shows how the signals from the PAL are used to control the sequencing of the input signals to the input of the instrumentation amplifier.

The instrumentation amplifier (IC4 and IC9-b back in Fig. 5) is one of the key signal-processing elements in the ECG design. It is a differential amplifier so its output is equal to the difference between its two inputs multiplied by a gain. In this application, the gain is approximately 1000.

The amplifier also has an input offset adjustment, R12, to compensate for minute differences in the input voltages, as well as an output offset capability at pin 7. In this design, the output offset at pin 7 is biased by IC5, a precision voltage reference, to a constant voltage near 2.5 volts. When the difference between the inputs of the instrumentation amplifier is zero, the output will be 2.5 volts. As the differential input voltage changes from zero, the output of the amplifier will change from 2.5 volts by an amount equal to the input difference times the gain.

The final stage in the analog signal path is the isolation circuitry to the A/D converter. It consists of IC9-a, IC16-c, and IC10-d. As the voltage into IC9-a changes, the current through the LED portion of optoisolator IC16-c changes, which modulates the base of the light-sensitive transistor in the optoisolator. That causes the collector current to change, developing a voltage change across the emitter resistor. That voltage follows the original voltage signal at the input of IC9-a with a 180-degree phase difference. To correct the phase reversal and to compensate for bias and gain errors, the signal is fed through amplifier IC10-d prior to going to the con-

TABLE 2—CONTROL SIGNAL DEFINITION

Signal	IC16 Output							
	Q8	Q7	Q6	Q5	Q4	Q3	Q2	Q1
Batteries On	1	1	X	X	X	X	X	X
IC21WR	X	X	X	X	X	X	X	0
IC21CS	X	X	X	X	X	X	0	X
IC22WR	X	X	X	X	X	0	X	X
IC22CS	X	X	X	X	0	X	X	X
IC20CS	X	X	X	0	X	X	X	X
IC20RD	X	X	0	X	X	X	X	X

troller board for A/D conversion. In addition to its gain function, IC1-d is also an active low-pass filter, with a cutoff frequency of about 100 Hz.

A high pass filter is also implemented in the final stage by feeding the ECG signal from the emitter of IC16-c through an active low-pass filter consisting of IC10-a and its associated components. The cutoff frequency for the low-pass filter is about 0.1 Hz, and the output is fed back through IC16-d to the positive input of IC9-a where it is used to cancel frequency components of the original signal below 0.1 Hz. As a result, the frequency components of the ECG signal are limited to a band between 0.1 Hz and 100 Hz.

Controller operation

The controller contains a Z80-based computer and a digital control section which combine to provide all the sequencing, timing, and control signals for the ECG (see Fig. 8). The Z80 microprocessor (IC1) is clocked by an 8-MHz oscillator, XTAL2. Octal bus transceivers IC2–IC5 buffer the microprocessor control, address, and data buses, and, in the case of IC5, provide bi-directional capability on the data bus. Programmable logic devices (PLD's) IC6, IC7, and IC8 generate various bus-control and chip-select signals to select the appropriate memory and I/O chips. The 32K × 8 EPROM (IC9) stores the CPU operating system and the ECG control program. Two 32K × 8 static RAM's, IC10 and IC11, provide the CPU with 64K of RAM. Communication with the outside world is provided through a universal asynchronous receiver/transmitter (UART), IC15, and its associated line transceiver IC19.

Power for most of the circuitry on the controller board is pro-

vided by a 9-volt battery (B1) located on the front-end board. To extend battery life, the system is powered only during the time required for a single ECG, with each ECG sequence initiated by depressing the reset switch. That is accomplished by powering the start-up circuitry from the RS-232 port on the PC. V_{CC} for the power-on latch, IC26, is provided by the 5-volt Zener-diode regulator, D5.

When the reset switch is depressed, the power-on latch changes state, turning Q1 on and completing the return path for B1. Power for the controller board is provided by the 5-volt regulator, IC32. A +6-volt supply for the analog circuits on the controller board is provided by IC30. The -6-volt supply for the analog circuitry is provided by IC29, a DC-DC converter. The two 6-volt supplies are also used to power portions of the front-end that don't require patient isolation.

The remaining IC's on the controller board are used to generate the control signals and to digitize the ECG data from the nine patient leads. Components IC13 and IC14 decode I/O instructions from the controller to produce control pulses that sequence the acquisition of the ECG data. Table 1 lists the control pulse generated by each I/O port address.

Each time I/O port 52 is addressed, the resulting pulse clocks IC18-a, a D-type flip-flop wired to divide by two. Two outputs to the I/O port produce a single pulse at the output of IC18-a. The pulse is passed to the clock input of IC8 on the front-end board through IC14, an optoisolator also on the front-end board. In a similar manner, a CLEAR pulse is developed at the CLEAR input to IC8 on the front-end board when the controller

continued on page 46

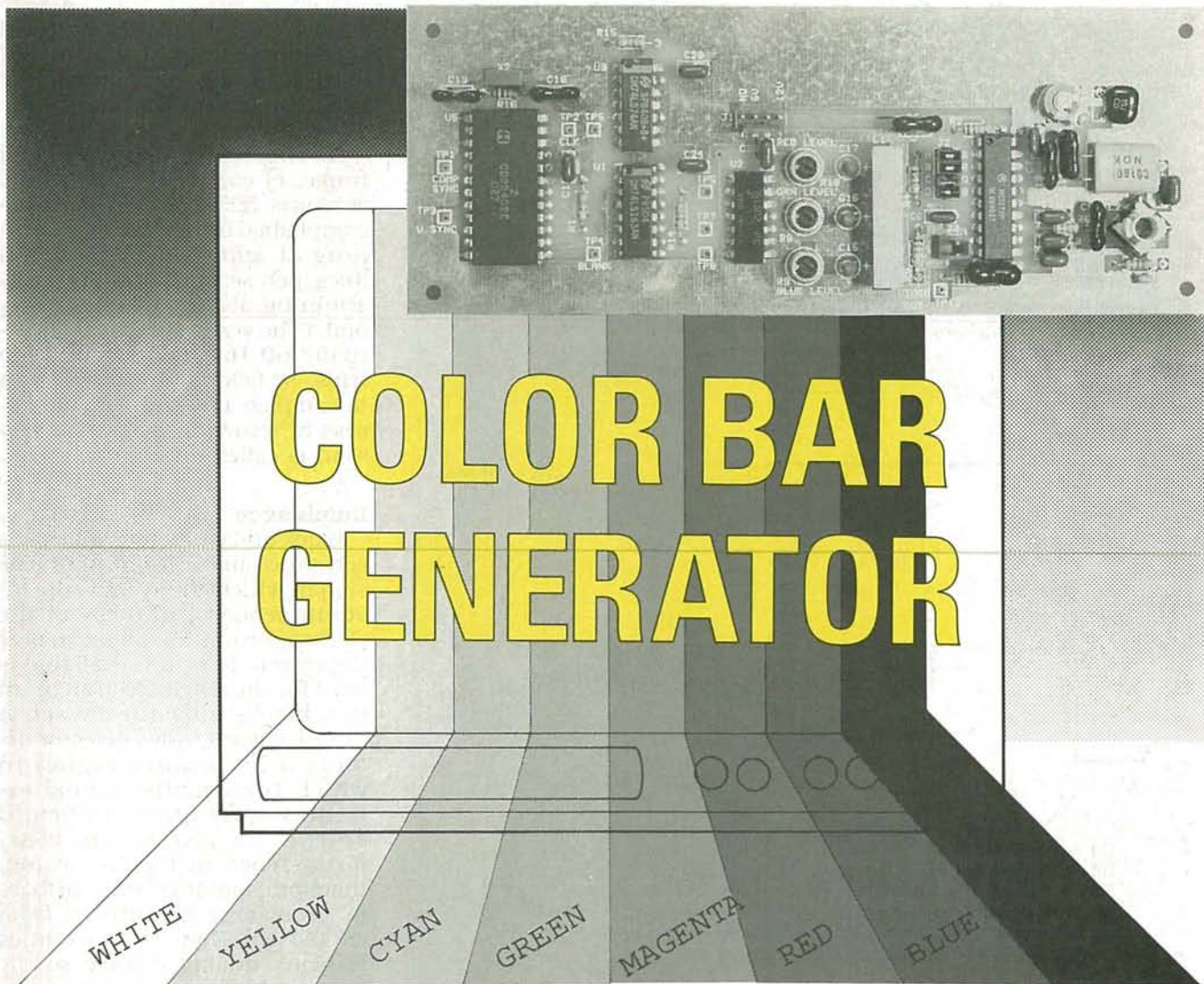

Build this inexpensive color-bar test generator and brush up on your video skills.

THOMAS GOULD WB6P

IF YOU'RE INVOLVED IN TV SERVICING and repair, or just enjoy tinkering around with video or amateur television, you'll be interested in this color-bar test generator. This convenient device produces an NTSC color-bar pattern that can be used for video performance testing and monitor adjustments. For added flexibility, just the encoder section can be used to generate composite video from your computer's RGB and sync outputs. With a dedicated color-bar generator, you can eliminate the need for a test tape or your camera—all for under \$70!

Before we delve into the theory behind the color-bar generator,

let's briefly discuss the various components that make up the composite NTSC video signal: synchronization, luminance, and chrominance information.

The NTSC signal

A typical NTSC composite color video signal is shown in Fig. 1-a. (NTSC is the National Television Systems Committee, who has set the standards for color encoding and decoding systems in the U.S. since 1953.) The picture on a color TV is formed by three electron beams of varying amplitudes and phases: red, blue, and green. Each of those beams are scanned horizontally and ver-

tically over the screen. As the beams scan, their currents and amplitudes change to create the light and dark areas on the picture-tube face and form the image that you see displayed on the screen.

The composite video signal is made up of three basic components: the scan control information called the synchronizing pulses (Fig. 1-b), the luminance signal, which is the brightness information and is often referred to as the Y signal (Fig. 1-c), and the color information called the chrominance signal (Fig. 1-d). Let's briefly discuss each type of video information.

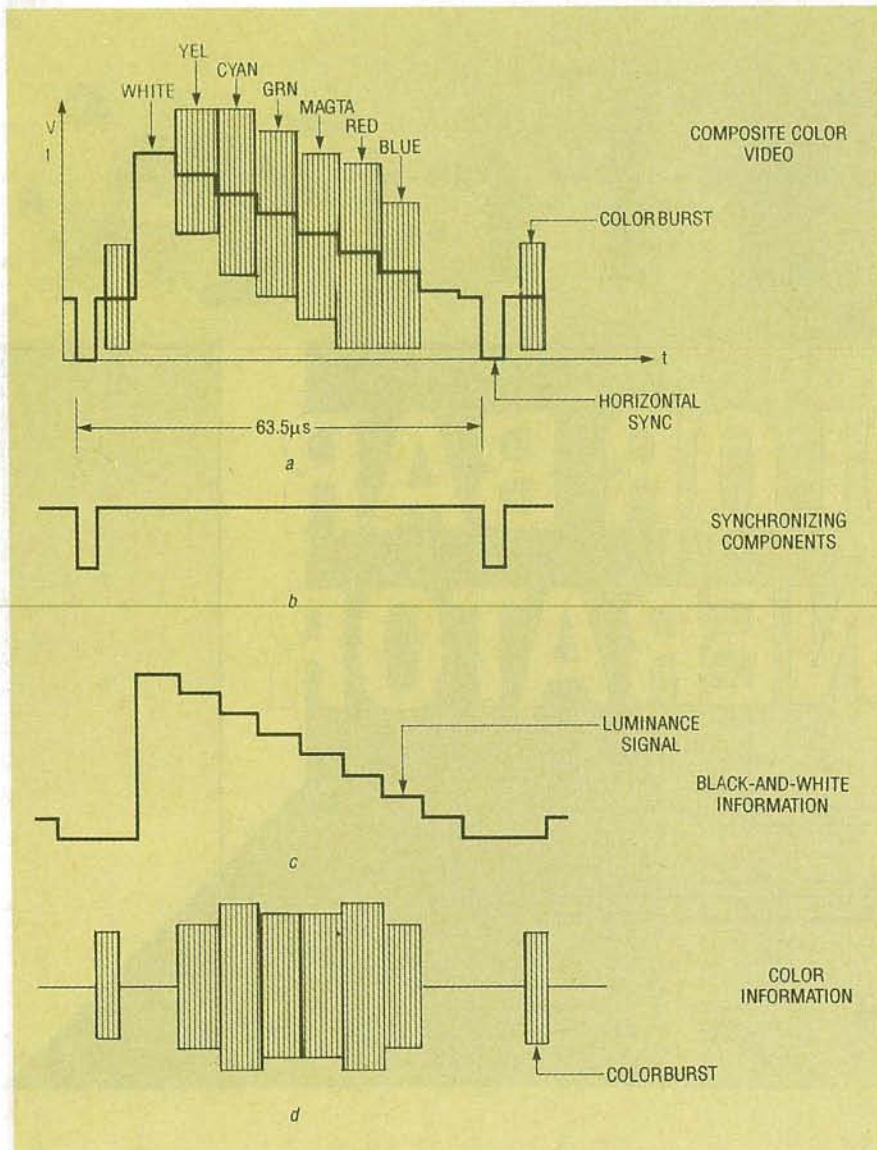

FIG. 1—A COMPOSITE VIDEO SIGNAL (a) includes sync pulses (b), black-and-white information (c), and the colorburst signal (d).

Synchronizing components

In order for a picture to be reproduced properly, the TV receiver must scan its screen exactly in step with the camera in the studio. To make sure the camera and the receiver are synchronized, a series of pulses are

sent to the camera telling it when to start at the top of the screen and when to begin a new line at the left of the screen. Those same pulses are sent to the receiver along with the video information. The signals that tell the camera and receiver when to

start at the top are called vertical sync pulses, while those that start scanning each line at the left are known as horizontal sync pulses.

In the NTSC system, each frame, of complete video image, contains 525 lines. That is accomplished by horizontally scanning at approximately 15,750 lines per second, and vertically scanning at 30 frames per second. (The vertical scan rate is actually 60 Hz, but it takes two trips, or fields, down the screen to complete one frame.) The process of returning to start a new scan is called retrace or flyback.

Luminance

Black and white information is contained in the Y or luminance signal, which determines the instantaneous brightness of the electron beams as they scan over the screen. In fact, it is all that is used for the single electron beam in a black-and-white TV set. A negative-going video detector detects a luminance signal in which the negative signal extremes correspond to bright areas of the picture. The waveform shown in Fig. 1-c would, therefore, produce vertical bars of decreasing brightness from left to right. Note that the output is black during retrace so the electron beams will not be seen.

In the NTSC color system, the Y signal is made from the red, green, and blue cameras by an additive technique: 30% of the red signal, 59% of the green signal, and 11% of the blue signal are added together to form the Y signal. The luminance signal can also be expressed as

$$E_Y = .30E_R + .59E_G + .11E_B$$

where E_R , E_G , and E_B are the voltages of the red, blue, and green signals, respectively.

The combination of different amplitudes of color signals is what determines the various shades of gray in a monochrome receiver—white having a luminance of one, black a luminance of zero. The ability of a receiver to determine a corresponding level of gray from color levels is an important feature in the compatibility of color and monochrome TVs because the black-and-white signals can be obtained from the three primary color signals.

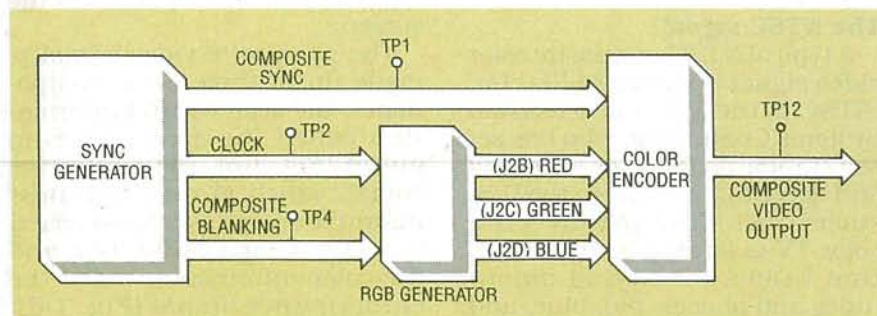

FIG. 2—A BLOCK DIAGRAM of the color-bar generator shows the main components of the circuit: RCA's CD22402E sync generator and Motorola's MC1377P color encoder.

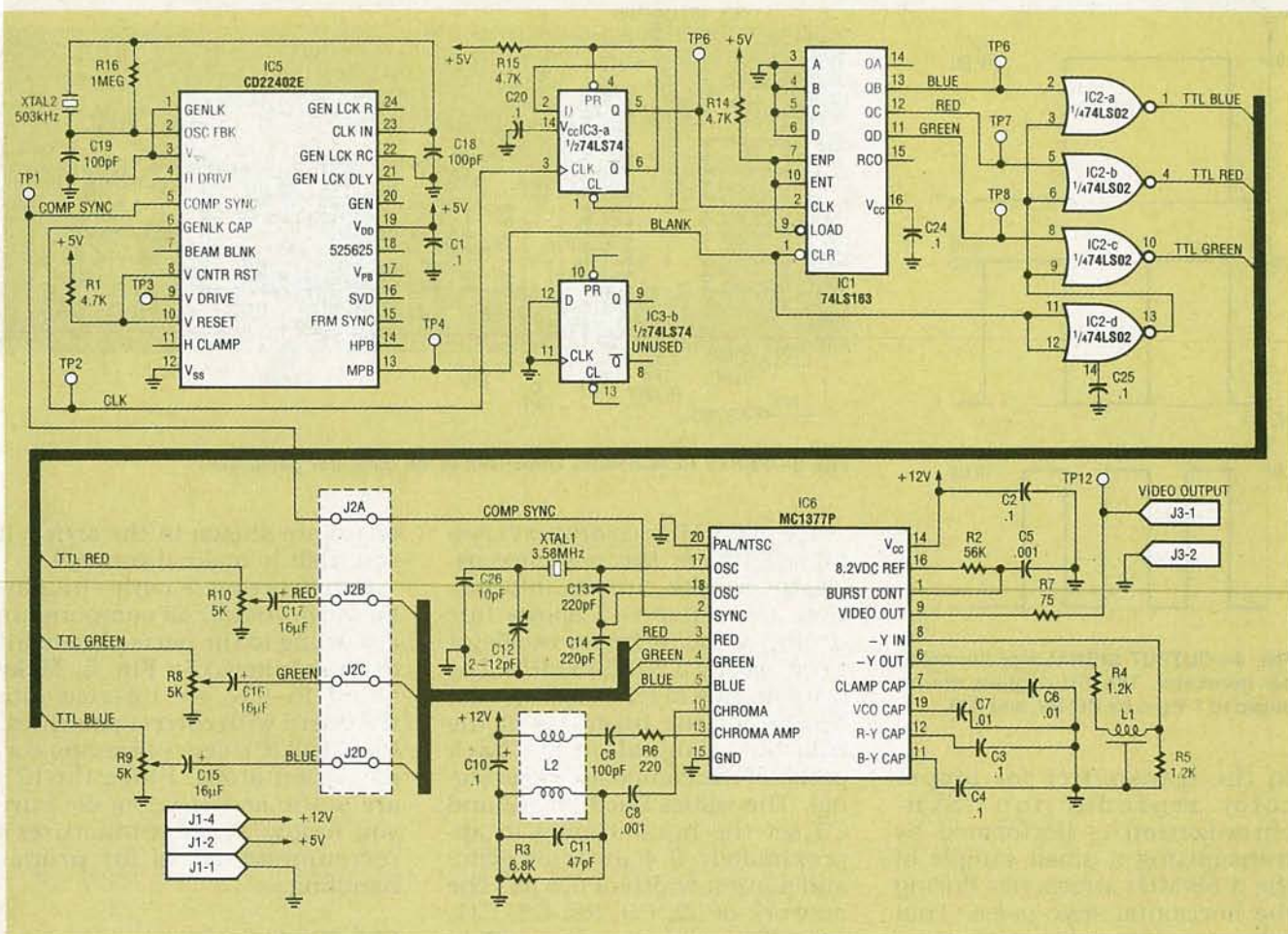

FIG. 3—SCHEMATIC OF THE COLOR-BAR GENERATOR. Sync generator IC5 provides the composite-sync timing signals, color encoder IC6 takes the separate red, green, and blue video signals and composite sync to generate the composite video signal.

All resistors are ¼-watt, 5%, unless otherwise indicated.

R1, R14, R15—4700 ohms
 R2—56,000 ohms
 R3—6800 ohms
 R4, R5—1200 ohms
 R6—220 ohms
 R7—75 ohms
 R8—R10—5000-ohm potentiometer
 R16—1 megohm

Capacitors

C1—C4, C10, C20, C24, C25—0.1 µF, bi-polar electrolytic
 C5, C8—1000 pF, mica
 C6, C7—0.01 µF, bi-polar electrolytic
 C9, C18, C19—100 pF, mica
 C11—47 pF, mica
 C12—2–12 pF variable ceramic capacitor
 C26—10 pF, mica
 C13, C14—220 pF, mica
 C15—C17—15 µF, electrolytic

Semiconductors

IC1—74LS163 counter
 IC2—74L02 quad NOR gate
 IC3—74LS74 flip-flop
 IC4—not used
 IC5—CD22402 sync generator, RCA
 IC6—MC1377 color encoder,

Motorola
 Other components

L1—400-ns delay line (TK1001)
 L2—30 µH, 2.52-MHz transformer (TK1603)

XTAL1—3.58-MHz colorburst crystal
 XTAL2—503-kHz ceramic resonator

Miscellaneous: enclosure, stand-offs for mounting circuit board, 4-pin friction-lock connector for J1, straight-header connector for J2, 2-pin friction-lock connector for J3, four shorting jumpers, wire, solder, etc.

Note: The following items are available from Geko Labs, 13019 250th Place SE., Issaquah, WA 98027-6730, (206) 392-0638: etched, drilled and plated-through PC board \$30.00; a complete kit including all parts, PC board, and assembly instructions \$80.00; a complete assembled and tested unit \$125. Add \$5.00 S & H with any order. Washington residents add 8.1% sales tax.

Chrominance

The color information, or chrominance, (which is ignored in a black-and-white TV) is made up of red, blue, and green signals required to drive the picture tube, minus the luminance signal. Those "color-difference" signals are designated as R-Y (red minus Y), and B-Y (blue minus Y). Color-difference signals are used solely for color reproduction. A special matrix circuit in the receiver can extract a G-Y (green minus Y) signal from the B-Y and R-Y signals. The advantage of changing the color signals into color-difference signals is the reduction of three color signals into two.

The R-Y, B-Y, and G-Y signals are decoded at the receiver by adding the Y signal back to each of the difference signals. A 3.58-MHz subcarrier is sent by the transmitter and used in the receiver to restore the original color information.

The frequency and phase angle of the 3.58-MHz subcarrier in the receiver must be the same as that

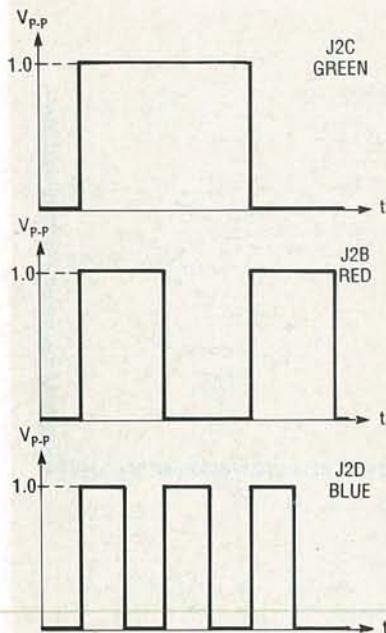

FIG. 4—OUTPUT SIGNALS of the color-bar generator. The TTL signals are reduced to 1 V p-p by R8, R9, and R10.

in the transmitter for proper color reproduction. Synchronization is performed by transmitting a small sample of the 3.58-MHz subcarrier during the horizontal sync pulse. That color sync interval is also known as the colorburst. The colorburst signal is used as a reference to synchronize the phase and amplitude of the color subcarrier. The colorburst also determines the tint and saturation of the color that is displayed.

Theory of operation

Figure 2 shows a block diagram, and Fig. 3 a schematic of our video generator. Sync generator IC5 is used to provide the composite-sync timing signals. The outputs are composite sync, composite blanking, and a buffered output of the sync oscillator. The sync generator uses a 503-kHz ceramic resonator (XTAL2) as a base oscillator. The 503-kHz frequency is divided by 32 for the horizontal sync, and is further divided to derive the vertical sync-timing signals. Those signals are all combined into the composite-sync signal which is sent to the MC131377 color encoder (IC6). The color encoder takes the separate red, green, and blue video signals and composite sync to generate the composite-video signal.

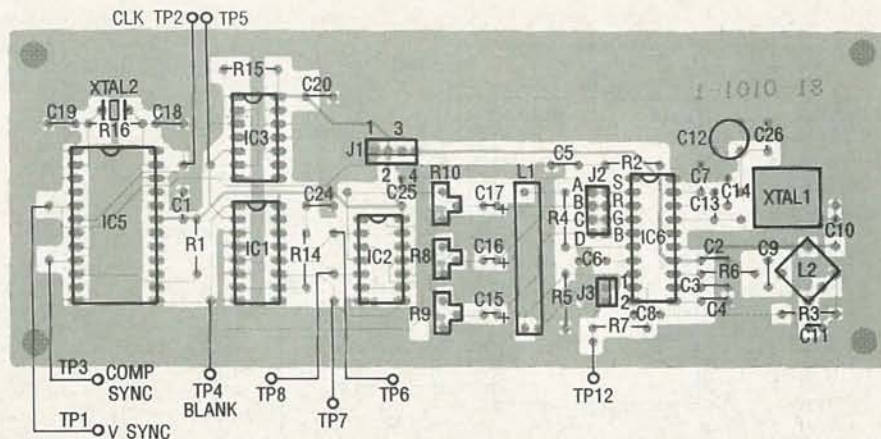

FIG. 5—PARTS PLACEMENT DIAGRAM of the color-bar generator.

The 3.58-MHz colorburst crystal, XTAL1, is the reference oscillator for the chroma information. Capacitor C12 allows fine tuning of the reference oscillator to be exactly 3.579545 MHz. The combination of R2 and C5 set the timing for the insertion of the colorburst signal on the back porch of the composite video signal. The values used for R2 and C5 set the burst timing to approximately 0.4 μ s after sync, and a burst width of 0.6 μ s. The network of L2, C9, R6, C8, C11, and R3 provide bandpass filtering for the chroma component. A delay for the luminance channel (-Y) is provided by R4, L1, and R5 to compensate for the internal delay of the chroma signal.

RGB generators IC1, IC2, and IC3 make up the red, green, and blue video signals that drive the video encoder section to make the color bars. One half of IC1 is used as a divide-by-2 counter, which generates the 252-kHz clock for the four-bit counter IC1. The non-inverted blue, red, and green signals are the divide-by-4, -8, and -16 outputs of IC1, respectively. The blue, red, and green signals are inverted, and blanking is added by IC2. The TTL level is reduced to 1 volt p-p by R8, R9, and R10, as shown in Fig. 4.

Construction

The video generator uses a double-sided PC board that is available from the source mentioned in the parts list. We recommend that you use a PC board for this project because the frequencies involved require a large ground plane. Both the component and the solder side of the PC

board are shown in the article if you wish to make it yourself.

Construction is fairly straightforward. Install all components according to the parts placement diagram shown in Fig. 5. Make sure C15-C17 are inserted into the board with correct polarities. Install all IC's last, observing correct orientation. Since the IC's are static sensitive, make sure you follow the manufacturer's recommendations for proper handling.

Checkout

The measurements listed in this section will help to make sure the video generator is working properly. The power on tests should be made with the +12- and +5-V power sources on. Set R8, R9, and R10 to mid range. If you are the impatient type you can go right to the video output test point TP12 and see what you get. If you're lucky you'll have a video signal that probably needs some adjustments. If that's the case you can proceed directly to the video adjustments section. If not, proceed slowly through the following steps to isolate the problem and verify each of the listed voltages, frequencies and waveforms. Keep in mind that you will need an oscilloscope for the video level adjustments.

- Pin 2 of J1 and +5 V \rightarrow 2000 ohms (power off)
- Pin 4 of J1 and +12 V \rightarrow 1 megohm (power off)

Power-on Tests

- +12-V supply—57 mA
- +5-V supply—29 mA
- IC1 pin 16—+5 V
- IC2 pin 14—+5 V
- IC3 pin 14—+5 V

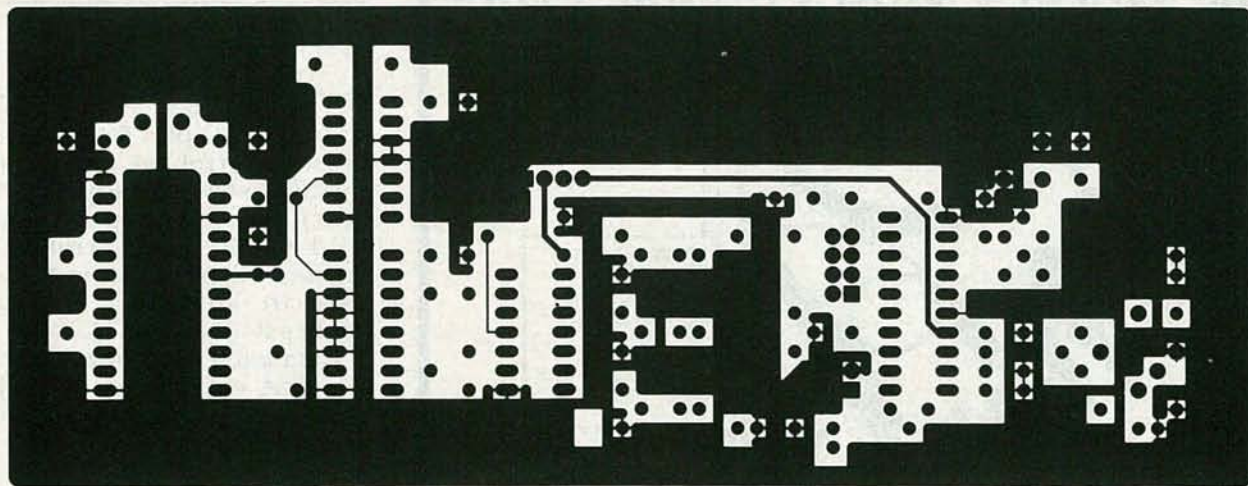

6 1/2 INCHES

FOIL PATTERN OF THE COMPONENT side of the double-sided PC board.

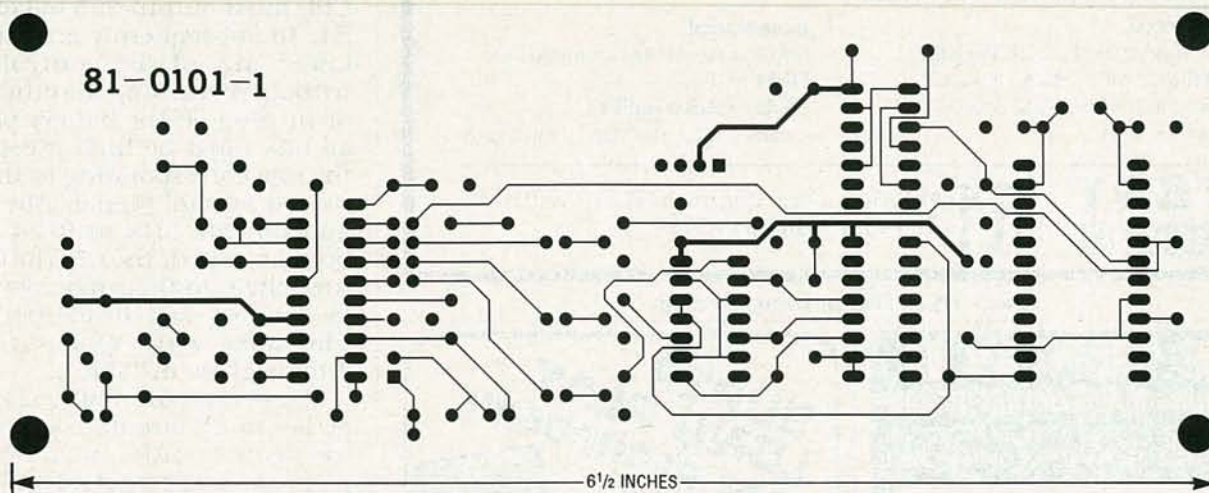

6 1/2 INCHES

FOIL PATTERN OF THE SOLDER SIDE of the PC board.

- IC5 pin 19—+5 V
- IC5 pin 6 (TP2)—2.504-kHz, 5-V p-p (TTL level) square wave
- IC5 pin 5 (TP1)—TTL-level composite-sync signal
- IC5 pin 13 (TP4)—TTL-level blanking signal
- IC3 pin 5 (TP5)—252-kHz signal
- IC1 pins 11–13 (TP6, 7, 8)—Divided down signals

Sync Generator

- IC5 pin 19—+5 V
- IC5 pin 5 (TP1)—TTL-level composite-sync signal
- IC5 pin 6 (TP2)—504-kHz, 5-V p-p TTL-level square wave
- IC5 pin 13 (TP4)—TTL-level blanking signal

RGB Generator

- IC1 pin 16—+5 V
- IC2 pin 14—+5 V
- IC3 pin 14—+5 V
- IC3 pin 5 (TP5)—252-kHz signal

- IC1 pins 11–13 (TP6, 7 and 8)—Divided down signals as shown in Fig. 4

Color Encoder

- IC6 pin 14—+12 V
- IC6 pin 2—TTL-level composite-sync signal (Fig. 1-b)

Amateur Television Quarterly

This article originally appeared in ATVQ magazine. ATVQ is a quarterly publication featuring technical articles on subjects related to ham radio, including VHF, UHF, amateur TV (ATV), computer programs, and repeater projects. ATVQ is enjoyed by hams of all levels, from beginner to Extra class. A subscription to this magazine is available for \$15 per year, \$4.00 for a sample copy (Visa and Mastercard are accepted). For more information contact

Amateur Television Quarterly
1545 Lee St. #73
Des Plaines, IL 60018
(708) 298-2269

- IC6 pins 3–5—1 V p-p signal
- IC6 pins 17 and 18—3.58-MHz oscillator signal
- IC6 pin 16—8.2 VDC
- IC6 pin 1—Ramp signal
- IC6 pins 10 and 13—Chroma signal (Fig. 1-d)
- IC6 pins 6 and 8—Luminance signal (Fig. 1-c)
- IC6 pin 9—2 V p-p (Fig. 1-a signal)

Video Level Adjustments

- IC6 pin 4 (J2C)—Adjust R8 to 1 V p-p
- IC6 pin 3 (J2B)—Adjust R10 to 1 V p-p
- IC6 pin 5 (J2D)—Adjust R9 to 1 V p-p
- J3 pin 1—Terminate into a 75-ohm connector
- Video Output (TP12)—Composite 1-V p-p signal. If you can't get this signal, adjust R8 for the proper peak level and null out the

continued on page 79

The World's Most Popular Probe



Free

Model SP100
100 MHz Switchable 1x-10x **\$45**

Free probe guide shows economical replacements for Tektronix, H-P, Philips and all others

More SP100 Probes Have Been Sold Worldwide Than Any Other Probe Ever Made

- **Universal**
For Tektronix, Hewlett Packard, Philips, Leader, B&K, Kikusui, Hitachi, Beckman and other oscilloscopes
- **Economical**
Substantial savings compared to OEM probes
- **10 day return policy**
Guaranteed performance and quality

**TEST
PROBES, INC.**



9178 Brown Deer Road, San Diego, CA 92121
Toll Free 1-800-368-5719

CIRCLE 123 ON FREE INFORMATION CARD

LEARN VCR CLEANING/MAINTENANCE/REPAIR

EARN UP TO \$1000 A WEEK, WORKING PART TIME FROM YOUR OWN HOME!



Secrets Revealed!

NO Special Tools or Equipment Needed.

EARN UP TO \$60 AN HOUR AND MORE!

THE MONEY MAKING OPPORTUNITY OF THE 1990'S

IF you are able to work with common small hand tools, and are familiar with basic electronics (i.e. able to use voltmeter, understand DC electronics). . . . IF you possess average mechanical ability, and have a VCR on which to practice and learn. . . . then we can teach **YOU** VCR maintenance and repair!

FACT: up to 90% of ALL VCR malfunctions are due to simple MECHANICAL or ELECTRO-MECHANICAL breakdowns!

FACT: over 77 million VCRs in use today nationwide! Average VCR needs service or repair every 12 to 18 months!

Viejo's 400 PAGE TRAINING MANUAL (over 500 photos and illustrations) and **AWARD-WINNING VIDEO TRAINING TAPE** reveals the **SECRETS** of VCR maintenance and repair—"real world" information that is **NOT** available elsewhere!

Also includes all the info you'll need regarding the **BUSINESS-SIDE** of running a successful service operation!

FREE INFORMATION
CALL TOLL-FREE 1-800-537-0589
Or write to: Viejo Publications Inc.
5329 Fountain Ave.
Los Angeles, CA 90029 Dept. RE

CIRCLE 187 ON FREE INFORMATION CARD

SUPER LONG PLAY TAPE RECORDERS

12 Hour Model —
USES 120 TAPE
\$119.00*

Modified Panasonic Slimline, high quality AC-DC provide 6 continuous hours of quality recording & playback on each side of cassette for 12 hours total. Includes • Voice level control • Digital counter, etc. TDK -120 Cassette Furnished.



PHONE RECORDING ADAPTER

Records calls automatically. All Solid state connects to your telephone jack and tape recorder. Starts recording when phone is lifted. Stops when you hang up.

\$28.50*

FCC APPROVED

VOX VOICE ACTIVATED CONTROL SWITCH
Solid state. Self contained. Adjustable sensitivity. Voices or other sounds automatically activate and control recorder. Uses either recorder or remote mike. \$28.50*

* Add for ship. & handling. Phone Adapter & Vox \$2.00 each. Recorders \$5.00 each. Calif. Res. add tax. Mail order, VISA, M/C, COD's OK. Money Back Guarantee. Quantity discounts available. Dealer Inquiries invited. Free data.
AMC SALES INC. Dept. A 9335 Lubec Street
Box 928, Downey, CA 90241
Phones (213) 869-8519 1-800-926-2488
FAX (213) 923-1478
Mon-Fri 8-5 PAC. TIME

CIRCLE 108 ON FREE INFORMATION CARD

ECC

continued from page 40

addresses I/O port 53. These two pulses control the operation of the ECG signal multiplexer. The other two pulses produced at IC14 when the controller addresses I/O ports 54 and 55 are used to latch data into octal latches IC16 and IC17.

Data latch IC17 stores data for the D/A converters IC21 and IC22. Latch IC16 is used to derive additional control signals.

Table 2 shows that to turn both batteries on and to place the other control signals in an inactive state, all output bits of IC16 must be a 1. To achieve that, the CPU must output 255 to I/O port 54. To subsequently activate, or lower, any of the control bits without disturbing the other bits or turning off the battery power, all bits must be high except for the one corresponding to the activated control signal. After the appropriate bits in IC24 have been activated, the CPU must return them to their inactive state by sending 255 to I/O port 54. The same logic applies to the other signals in Table 2.

To see how this all works together in the circuit, let's assume we need to turn on both the positive and negative battery-powered supplies on the front-end board, and write a 127 to IC21 on the controller board. First, the CPU outputs a 255 to I/O port 54. That places a "1" at all outputs of IC16. The "1" at Q8 of IC16 produces a current flow in the LED of optoisolator IC16-a, causing current to flow through its associated transistor. The ensuing voltage drop across R60 turns FET Q1 on, completing the battery input circuit to the -6-volt regulator, IC11. The negative supply is now on. The positive supplies are turned on by the "1" on Q7 of IC16.

Now the CPU must place our arbitrarily chosen value, 127, into the octal latch, IC17, on the controller board. As shown in Table 1, that is accomplished by writing 127 to I/O port 55. Once the correct number is in the latch, the CPU must write it to the D/A converter. Notice that the outputs of the octal latch, IC17,

continued on page 88

GERARD ROBIDOUX AND
ROBERT DMITROCA*

LAST MONTH WE INTRODUCED THE 16-channel, 50-MHz logic analyzer. We discussed all the capabilities of this digital-test instrument, and the theory behind its operation. This month we'll show you how to build it.

Construction

The logic analyzer consists of two PC boards, a case, and an overlay. Due to the extremely high-speed logic used in this design, it is critical that PCB's be used. Wire-wrap and point-to-point construction techniques will not work!

A photo of the inside of an assembled unit is shown in Fig. 7. The main logic board has four circuit layers: two signal layers, one power, and one ground plane. The PC board can only be fabricated by a fairly sophisticated board vendor. Because of that, foil patterns have not been provided in this article. A finished board and all the required parts, however, are available from the source mentioned in the Parts List. Figure 8 shows an internal photo of the unit with the LCD panel removed.

Figure 9 shows the parts-placement diagram. Make sure you observe the correct component orientation and capacitor polarities when soldering the components. Assemble the keyboard first, because it is the simplest circuit. Note how the keys are placed on the component side of the circuit board, as shown in Fig. 9. The keyboard connector, P1, must be placed on the solder side, in the position that is shown.

When soldering the keys, S1-S12, pay particular attention

*Gerard Robidoux and Robert Dmitroca are partners in Convention Systems, a software consulting company specializing in the design of low-cost test instrumentation.

LOGIC ANALYZER

Troubleshooting digital circuits is a cinch with this 16-channel, 50-MHz logic analyzer.



to their alignment. They must be straight with respect to the edge of the board and to each other, otherwise the cutouts in the case will not fit over them.

When you've finished soldering in the components, all flux *must* be removed from the circuit boards. We recommend that solder with a water-soluble flux be used, rather than the standard rosin core. Rosin-core flux must be removed with a freon based solvent, which is quite expensive. Water-soluble flux, however, can be cleaned off with warm tap water and a small brush (a toothbrush is remarkably effective). Kester solder with type 331 flux is a good one to use.

Assembling the main circuit board is also straightforward. In-

stall all mechanical components as shown in Fig. 10. Most of the components on the main board are CMOS, therefore they're quite sensitive to static electricity. Make sure you follow adequate precautions when handling those IC's. When assembling the main board, it is critical that you use a properly grounded three-wire soldering iron, and that your workbench is covered with an anti-static mat to avoid damage to the CMOS IC's.

Solder in all of the IC's and sockets first. Notice that IC1, IC2, IC30, IC32, IC40, IC44, IC45, and IC46 are socketed. The socket for IC30 has pin 1 facing to the left. The socket for IC40 is a Dallas Semiconductor Smart Socket. It does not use all of the

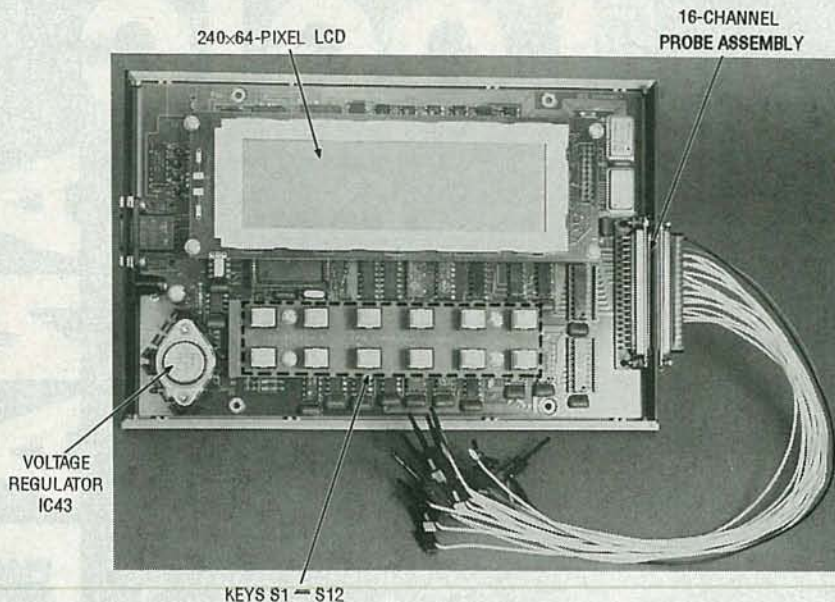

FIG. 7—INTERNAL PHOTO OF the logic analyzer. The main PC board has four layers: two signal layers, one power, and one ground plane. Wire wrap and point-to-point soldering techniques cannot be used because of extremely high-speed logic.

holes provided for IC40. Align that part in the lower part of the socket.

The capacitors and resistors should then be added, followed by connectors J1–J4, P1, and the header blocks P2–P4. Attach the heatsink to the voltage regulator, IC43, using a thin layer of conductive heat-sink cream. Secure that assembly to the board using 1/2-inch 4-40 screws, washers, and nuts.

The circuit board must be jumpered to work properly with the size of SRAM and ROM being used. To accomplish that place shorting blocks between P2 (pins 1-2), P3 (pins 2-3), and P4 (pins 2-3).

That completes the assembly of the main logic board. After cleaning the board of flux, carefully inspect it for good solder connections and make sure there are no solder bridges present. Touch up any cold or questionable solder joints.

Carefully inspect the alignment of all of the components. Insert the V25 microprocessor (IC30) into its socket. Make sure that pin 1 is aligned correctly. It's very difficult to remove a PLCC device from the socket once it's been inserted. Insert components IC1, IC11, IC44, IC45, and IC46. IC44 and IC45 are programmable logic devices (PLD's).

Acquisition connector

The acquisition clip assembly

consists of a DB-37 connector shell containing eighteen wires terminating in small micro-clips. It is supplied in a pre-assembled format.

There are three separate parts to each micro-clip assembly; the wire, the body, and the plunger. Each part can have a different color. The color coding is used to separate the function of the input lines; all data input channels have a white wire, the clock wire is green, the ground wire is black.

The plunger and body are used to distinguish the input channel numbers. Channel 0 has a black plunger and a black body, channel 1 has a brown plunger and a black body, channel 2 has a red plunger and a black body, and so on. Table 1 lists the cap, plunger, and wire color coding of the probe assembly.

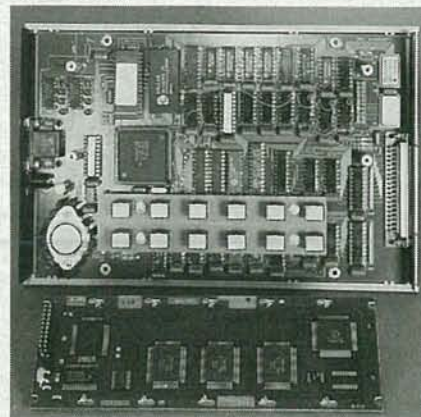

FIG. 8—INTERNAL PHOTO OF the logic analyzer with the LCD panel removed.

Final assembly

We're now ready for final assembly. To connect the LCD panel to the main logic board, connector P4 must be soldered onto the display. Connect P4 to the bottom side of the LCD panel (away from the LCD panel itself).

To complete the mechanical assembly, attach four 5/8-inch and four 3/8-inch standoffs to the circuit board as shown in Fig. 10. The shorter standoffs are used for the keyboard. Align the keyboard connector and attach it to the main circuit board. Do the same for the LCD panel.

Checkout

At this point we're ready to test the logic analyzer. Measure the resistance between pin 20 and pin 10 of IC1 (the power pins). The resistance should be above 20 ohms. If it's below that value, there's a short somewhere on the board. Do not power the unit up until you find it!

Plug the AC adapter into the wall outlet then plug it into J2. The LCD panel should display a brief title-page before running the software. (You can become familiar with the software running on the logic analyzer by reviewing the introductory sections in the manual provided with the kit or with the ROM). If you don't see the title page, then there's a problem with the microprocessor section (IC30, IC40, IC42, IC44, and IC46). The LCD contrast voltage at R10 should be around -10 volts. The voltage at IC1 pin 20 (+5-volt power supply) should be between 4.75 and 5.1 volts.

We will now test the internal clock generator circuits. For that test, you'll need a 100-MHz counter. Connect the counter to pin 5 of IC38. Go to the SYSTEM screen and select an internal clock. Then select each clock speed in turn. For each clock speed, make sure the counter shows the same speed on the display (for example, if a 10-MHz clock has been selected, the counter should show 10 MHz).

You can check the external clock signal input by selecting the external clock function. Using a function generator, place a TTL-level signal of a known frequency into the CLK pod. The counter should show the function generator's frequency.

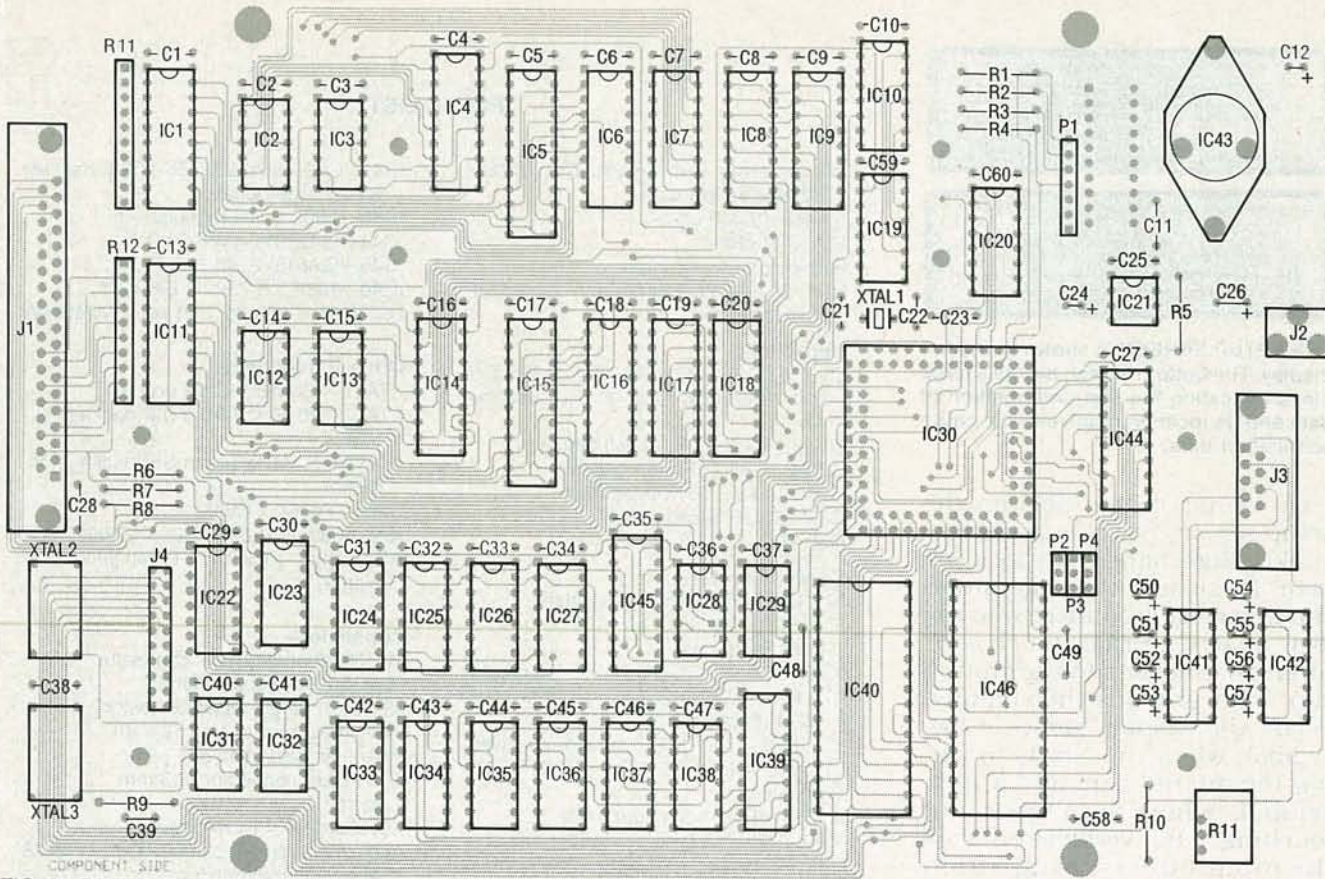

FIG. 9—PARTS-PLACEMENT DIAGRAM.

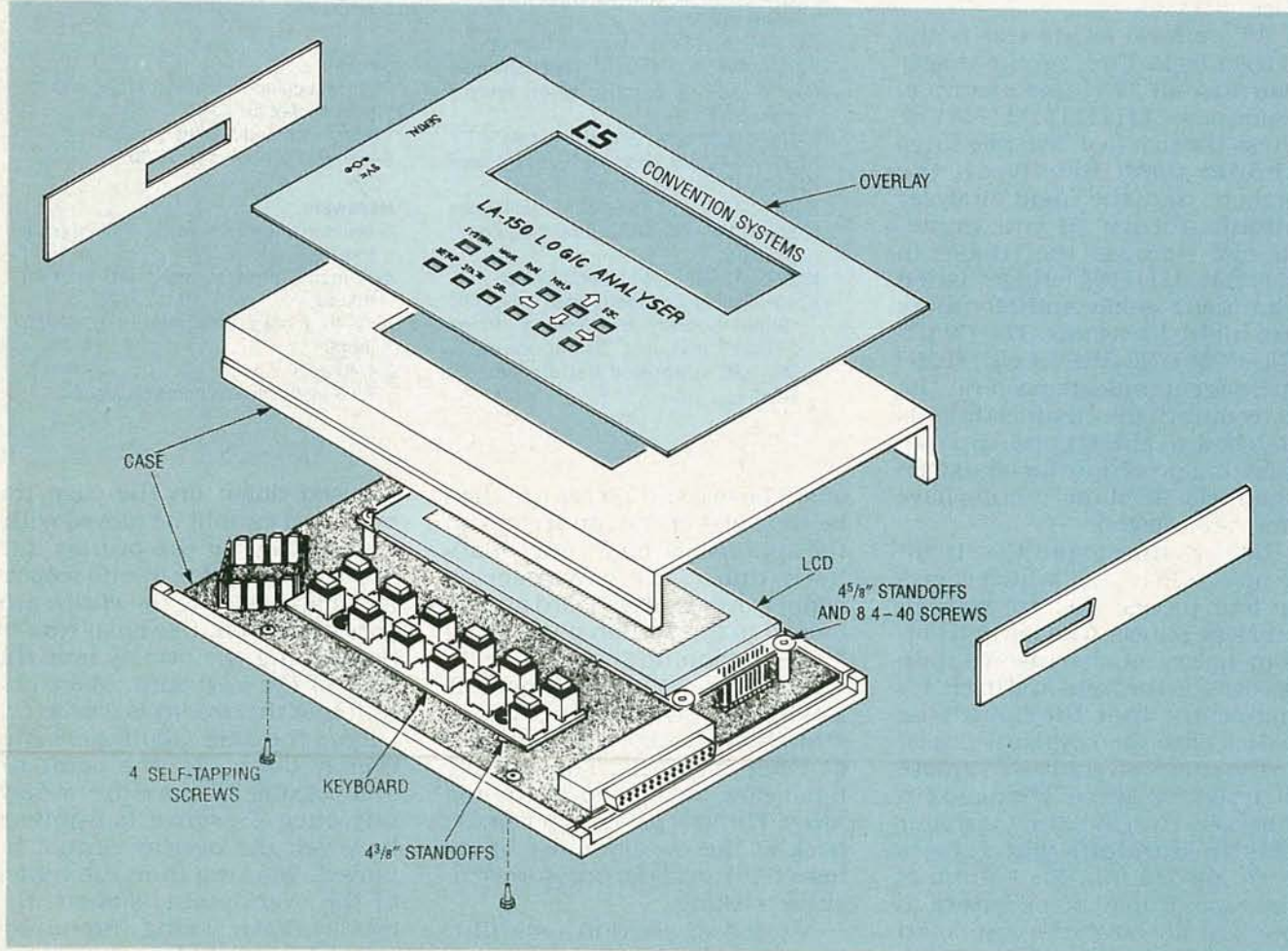
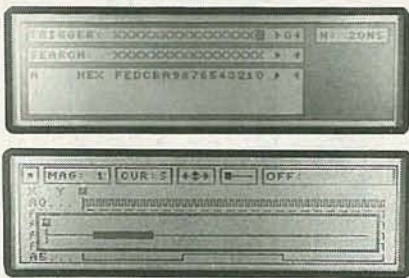

FIG. 10—THE ASSEMBLY DRAWING SHOWS how the case is secured together.



THE SETUP SCREEN is shown in the top display. The bottom screen shows a large block indicating the size and position of data and its location relative to the entire acquisition data.

Go to the SEARCH field on the setup screen. Select it using the SEL key, and change it to the INPUT item. Make sure the acquisition clip assembly is connected to the logic analyzer. Briefly touch each input channel clip to the ground clip. That grounds the channel. Verify the display shows a low symbol, when the clip is touching the ground clip, and a high symbol, when the clip is not touching. That verification tests the input buffers, acquisition RAM, and microprocessor interface.

All we have left to test is the trigger logic. First set the trigger word to all "1's" (for example, TRIGGER = "11111111111111"). Press the RUN key. Two messages should flash briefly on the screen, and the logic analyzer should return to you immediately. Now set the trigger to "1111111111110" (trigger when channel 1 is low and all others are high). Press RUN. The "WAITING FOR TRIGGER CONDITION" message should remain on the screen until the channel 0 clip is touched to the ground clip. Repeat that procedure for all sixteen channels. All of the circuits have now been tested.

Now it's time to put the circuit boards into a case, which comes in four pieces; the top, bottom, and side panels. The top and bottom halves of the case contain grooves on the front and back. It's important that the boards be placed with the keyboard closest to the side with the raised groove of the bottom piece. The main circuit board will fit tightly over four plastic standoffs which have been molded into the bottom of the case. It may be necessary to press firmly on the circuit board to force the holes over the stand-

PARTS LIST

All resistors are ¼-watt, 5%, unless otherwise indicated.

R1—R8—10,000 ohms
R9—470 ohms
R10—0 ohms, or jumper wire
RA1, RA2—1 megohm, 10-pin bussed SIP resistor array

Capacitors

C1—C11, C13—C20, C23, C25, C27—C38, C40—C49, C58—C60—0.1 µF, ceramic axial
C12, C24—3.3 µF, 10-volt tantalum
C21, C22—10 pF, ceramic disc
C26—100 µF, 25-volt tantalum
C39—50 pF, ceramic disc
C50—C57—22 µF, electrolytic

Semiconductors

IC1, IC11—74ACT574 8-bit latch
IC2, IC3, IC12, IC13—74ACT00 quad 2-input NAND gate
IC4, IC14—74ACT521 8-bit comparator
IC5, IC15—CY7C128A 2K × 8 15-ns static RAM (SRAM)
IC6, IC16—74HCT245 octal transceivers
IC7—IC9, IC17, IC18, IC39—74HCT574 8-bit latch
IC10—74F85 4-bit comparator
IC19, IC22—IC27—74ACT163 4-bit counter
IC20—74HCT138 3-to-8 demultiplexer
IC21—TL7705A voltage supervisor and reset control
IC28—74ACT74 dual D-type flip-flop
IC29—74ACT02 quad 2-input NOR gate
IC30—V25 high-integration microprocessor
IC31—74F32 quad 2-input OR gate
IC32—74ACT86 quad 2-input XOR gate
IC33—74F160 4-bit counter
IC34—74ACT153 dual 4-to-1 multiplexer
IC35—IC37—74LS390 dual bi-quinary counter
IC38—74ACT151 8-to-1 multiplexer
IC40—Dallas Semiconductor DS1213C "Smart Socket" and 32K × 8 100-ns SRAM or Dallas Semiconductor DS1235 integrated battery backed RAM

IC41, IC42—MAX232 RS-232 transceiver and charge pump
IC43—7805 5-volt regulator
IC44—GAL16V8-15LP PLD
IC45—GAL16V8-10LP PLD
IC46—128K × 8 250-ns EPROM
LCD panel—Sharp part no. LM24014W

Other components

XTAL1—16-MHz HC-49 crystal
XTAL2—20-MHz 14-pin DIP package oscillator
XTAL3—50-MHz 14-pin DIP package oscillator
Case—Pactec CM69-120
Key switches (12)—75120-002/0000
AC adapter—9 VDC at 1 amp secondary output

Connectors

J1—Right-angle DB37 connector
P2—P4—3-pin socket strip
J3—Right-angle DB9 connector
J4—20-pin socket strip (2 × 10)
P1—7-pin socket strip (1 × 7)
J2—Power connector (2.3-mm barrel)
Keyboard—7 × 1 row-header
Acquisition clip—DB37 connector with 18 wires and micro-clips.
P1—2 × 10 row-header connector for LCD panel

Sockets

20-pin machined sockets for IC1 and IC11
32-pin socket for IC46
14-pin machined socket for IC32
84-pin PLCC socket for IC30

Hardware

4 ¾-inch standoffs with 4-40 internal thread
4 ½-inch standoffs with 4-40 internal thread
18 4-40 screws with pan head, ¼-inch length
2 4-40 nuts
1 TO-3 heatsink and heatsink grease

offs. The two side pieces can then be slipped over the connectors on the appropriate ends. After that's been done, the top piece is slipped over the keyboard and attached to the bottom piece using four self-tapping screws.

At this point, make sure the keyboard and display are straight with respect to the edges of their cutouts. The overlay must now be applied to the top piece. The wax paper sheet on the back of the overlay must be removed to reveal the pressure-sensitive backing.

A word of caution regarding the glue used: once it's been

pressed down on the case the overlay, it cannot be moved without destroying the overlay and the case. This glue has no respect for mistakes! Peel the entire wax paper sheet off. Use great care in positioning the overlay over the keys of the keyboard. Make certain that the overlay is true to the edge of the case. Gently press the overlay down. At this point it's still possible to move the overlay, but once pressure is applied, however, the overlay cannot be moved. Working from the center of the overlay out, smooth the overlay down, being careful not to catch air bubbles.

TABLE 1—PROBE ASSEMBLY

Connector Pin No.	Cap Color	Plunger Color	Wire Color
1 (GND)	Black	Black	Black
4 (AQ14)	Brown	Yellow	White
5 (AQ13)	Brown	Orange	White
7 (AQ10)	Brown	Black	White
8 (AQ09)	Black	White	White
10 (AQ06)	Black	Blue	White
11 (AQ05)	Black	Green	White
13 (AQ02)	Black	Red	White
14 (AQ01)	Black	Brown	White
21 (CLK)	Green	Green	Green
22 (AQ15)	Brown	Green	White
24 (AQ12)	Brown	Red	White
25 (AQ11)	Brown	Brown	White
27 (AQ08)	Black	Grey	White
28 (AQ07)	Black	Purple	White
30 (AQ04)	Black	Yellow	White
31 (AQ03)	Black	Orange	White
33 (AQ0)	Black	Black	White

*Pins not listed are unused.

Software

The software which controls the logic analyzer is quite sophisticated and very complex. Since a thorough examination of it is beyond the scope of this article we'll only present the highlights of the software interface. The software listing is, however, available on the RE-BBS (516-293-2283, modem settings: 1200/2400, 8N1, file name: LA150.ARC). More information on the operation of the analyzer can be found in the user's guide. That document is provided with every kit or assembled unit, as well as with the separate ROM's, from the source in the Parts List.

Here are some of the special features that the software offers:

- **User Interface**—The logic analyzer has a friendly, consistent user interface. Pull-down and pop-up menus, form menus, and selection boxes enable you to easily configure the analyzer. Four distinct screens allow you to interact with the logic analyzer. Each portion of the screen is associated with one of the SYSTEM, SETUP, WAVE and STATE keys.

- **System Screen**—Most system-wide parameters are set up using this screen. The configuration name, clock type, clock speed, trigger position, and threshold

level are always displayed. A pull-down menu is provided which allows you to change communication and printer parameters.

- **Setup Screen**—The trigger word, search word, and acquisition line groups are defined in this screen. An input-line monitor allows you to view the current state of the input lines without having to start the acquisition cycle again.

- **Waveform Screen**—Displays the contents of the acquisition data buffer in graphical format. Two cursors are provided which let you determine the time relationships between signals. A pull-down menu is provided which allows you to jump to a particular location within the data, search for a pattern, or print out a continuous range of data.

- **State Screen**—Displays the contents of the acquisition data buffer in tabular format. Two cursors are provided which let you quickly determine the time relationships between signals. A pull-down menu, identical to that of the waveform screen, is also provided.

- **On-Line Help**—The logic analyzer contains a true context-sensitive on-line help system. Help is always available at the touch of

ORDERING INFORMATION

Note: The following items are available from Convention Systems, 1214-315 Southampton Dr. SW, Calgary AB, Canada T2W 2T6, (403) 253-4427. Send check or money order. Shipping is by ground delivery. Contact Convention Systems for additional charges if overnight delivery is desired. All items are postpaid, except as noted.

- Etched, drilled and plated main and keyboard PC boards—\$99.00.
- Preprogrammed EPROM, GAL16V8-15LP, and GAL16V8-10LP (IC44-IC46)—\$99.00
- Milled-out case with plastic overlay—\$79.00.
- Probe assembly—\$99.00
- AC adapter—\$15.00
- LCD panel—\$150.00
- IC30 V25 microprocessor—\$29.00
- Manual—\$32.00
- Complete kit, including probe assembly and AC adapter—\$695.00 plus \$20.00 S & H.
- A complete assembled unit, including probe assembly and AC adapter—\$695.00 plus \$20.00 shipping and handling.

the HELP key. Help is always given about the item that is currently highlighted.

- **RS-232 Interface**—The logic analyzer contains a serial RS-232 interface for connecting with external devices. The baud rate, data bits, stop bits, parity, and protocol can all be configured using this interface.

- **Printer Support**—A serial printer can be connected directly to the analyzer. All or part of the acquisition data may be printed out in waveform or state format. All formatting of the output is handled by the logic analyzer.

- **Slave-Mode Operation**—The logic analyzer can be controlled by a host or remote computer, therefore, it can be used in an automated test environment. Acquisition data and configuration settings can be downloaded to the host computer for storage and further manipulation. A library of IBM-PC based interface routines is provided with the logic analyzer.

The next time you find a problem with one of your digital designs, use the logic analyzer to quickly and effectively find the problem. You'll wonder how you ever did without it!

R-E

In previous installments we built computer-assisted test instruments to measure voltage, resistance, and capacitance. In this final installment, we'll round out our component inspection system (CIS) with a PC-based IC tester. Our tester can test all 14- and 16-pin CMOS and TTL IC's. It can also be modified to test any IC that requires digital inputs and provides digital outputs.

Testing methods

There are two common ways of testing digital circuits and IC's: transition and state testing. In transition testing, you provide a series of signals to the circuit and note the output transitions. Transition testing is beneficial when you are interested in the AC characteristics (slew rate, propagation time, etc.) of a circuit. Transition testing is, however, expensive and time-consuming.

With state testing, you change one input at a time and note any changes in the outputs. State testing can't check the high-speed response of an IC, but it does allow you to exercise an IC and determine whether it's good or bad. Our tester uses the technique of state-testing.

Specifications

An IC may be fully specified by a connection diagram, a block (or function) diagram, and a truth table. The connection diagram shows the physical layout and name of each pin. The block diagram shows the internal functions of the IC. The truth table lists outputs provided by various input combinations.

For example, Fig. 1 shows a connection diagram (a), function diagram (b), and truth table (c) for a 4011 CMOS quad two-input NAND gate. The connection diagram shows that the 4011 is a 14-pin IC with ground (V_{SS}) at pin 7 and +V (V_{DD}) at pin 14.

The other pins are labelled as well, but to find out what the labels mean, we must refer to the functional diagram (Fig. 1-b). Here we see four NAND gates, each with two inputs (A and B) and one output (Y). To find out how each gate works, we must examine the truth table (Fig. 1-c). For each gate, the output is high unless both inputs are high, in which case, the output is low.

Testing steps

Using the connection and functional diagrams, as well as the truth table, we must follow four steps to test an IC.

1. Determine its pinout, its logic functions, and its truth table.
2. Specify a series of inputs to exercise all of the functions.
3. Determine the proper outputs for each input combination.
4. Perform physical testing.

You get pinout, functional, and truth-table information from data books, which can be purchased from IC distributors. (They are also available at larger local libraries). Using that information, you then plan a series of inputs. Using the truth table as a guide, step through each of the possible inputs (or as many as necessary to determine proper function) and determine the proper outputs. A programming form (like that shown in Fig. 2) can be helpful in setting up a test program.

After setting up a test program, it's time to perform a physical test. Physical testing includes these four steps:

1. Initialize the IC to a predetermined state.
2. Apply inputs.
3. Monitor outputs.
4. Compare to what should occur; determine pass or fail.

For example, Fig. 2 shows a test program for the 4011. That program first initializes all inputs high. Actually, any initialization is fine (all inputs low, for example) as long as testing begins in a known, repeatable state. The actual test begins at step 9. One input on each gate is brought low, changing that gate's output from low to high. Then the input is returned low, making the output also return low.

The tester

For maximum flexibility, we designed a simple interface card, shown in Fig. 3. The heart of our card is a standard 8255 (IC2); the only other active component is a 74LS138 decoder (IC1) that allows you to choose an I/O port for communicating with the card. To avoid conflicts with other hardware devices, DIP switch S1 allows you to choose one of several different ports, ranging from 512 through 736 decimal.

The 8255 can function in sev-

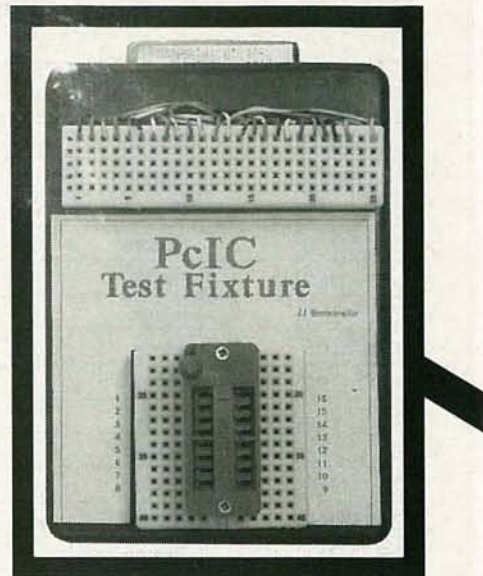

eral modes; we use Mode 0, in which each eight-bit register (PA, PB, and PC) can be programmed for input or output. A separate control register specifies how the data registers work.

If we program PA and PC as outputs and PB as input, we have eight inputs and 14 outputs. Conversely, programming PA and PC as inputs and PB as outputs gives us eight outputs and 14 inputs. With these two possibilities, we can test any 14- or 16-pin IC with any combination of inputs and outputs.

A standard 25-pin cable connects J2 on the I/O board in the PC to the test fixture, shown in Fig. 4, which consists of J1, two solderless breadboards, and SO1, a 16-pin zero-insertion-force (ZIF) socket. That arrangement allows any of the 24 lines from J1 to be connected to any of the 16 pins on SO1 with jumper wires.

Software

All our test and control programs are written in BASIC. Unfortunately, there is not enough space to present complete listings, but we will provide enough sample code so that you can understand the principles involved. In addition, we'll post compiled programs on the RE-BBS (516-293-2283, 1200/2400, 8N1; look for file PCTEST3.ZIP); software is also available on disk directly from the author, as discussed in the parts list.

EXPERIMENTING WITH PC-BASED TEST EQUIPMENT

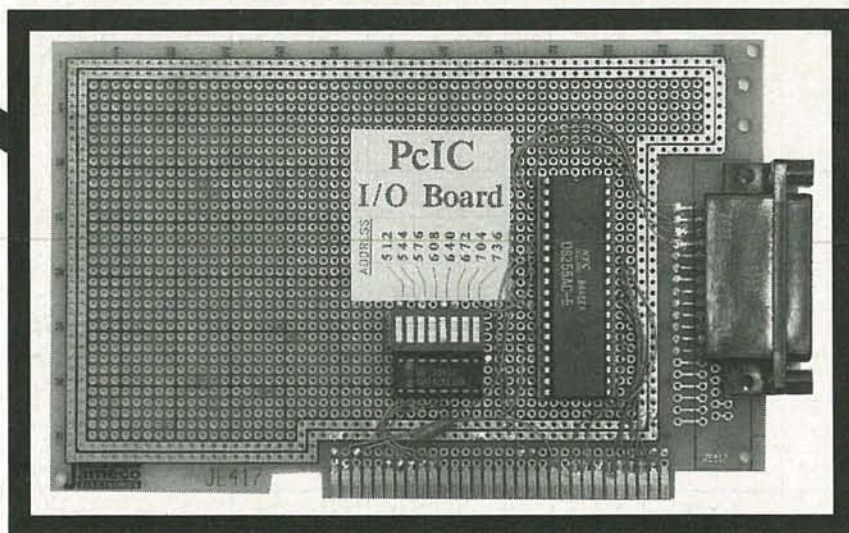

**Build this low-cost
(under \$100)
PC-based IC tester!**

JAMES J. BARBARELLO

The software needs to know the port address of the tester. If we define A as the address of PA (the decimal address selected by S1), then $B = A + 1$, $C = B + 1$, and $D = C + 1$, where B is PB, C is PC, and D is the control register. For example, if S1 is set for address 640, then:

```
10 A=640: B=641: C=642: D=643
```

Now, to set up the 8255 PPI, we must send an appropriate value to the control register. For PA=output, PB=input, and PC=output, that value is 130. For PA=input, PB=output, PC=input, the value is 153. For example, to set PA and PC as outputs, and PB as input, then:

```
20 OUT D, 130
```

After setting up the 8255, we can send and receive information to and from the registers. For example, to bring PA lines PA0 and PA2 high, and then sense those lines to make sure everything is working correctly:

```
30 OUT A, 5
```

```
40 IF INP(A) 5 THEN PRINT "There's A  
Problem With PA":END  
50 IF INP(A) = 5 THEN PRINT "Peripheral  
Register A is OK":END
```

To sense the status of the input register, PB, use the same approach as in lines 40 and 50. For example, to sense the status of PB5 (J2-14):

```
60 X=INP(B): X = X AND 8 : PRINT "PB5  
is":
```

```
70 IF X=0 THEN PRINT "Low"
```

```
80 IF X=8 THEN PRINT "High"
```

The value 8 is the decimal number associated with PB5. ANDing the result of the input (INP) isolates its value from the other PB bits. The value 8 is called a "mask." Mask values for bits 0 through 7, respectively, are 1, 2, 4, 8, 16, 32, 64, 128.

Combining ideas, we can create a small test program to tell us whether the tester is working at the selected address. Refer to Listing 1.

It's important to remember that outputs remain constant until you change them—in other words, outputs are latched. Inputs, on the other hand, are not latched. The value returned is what exists at the instant you

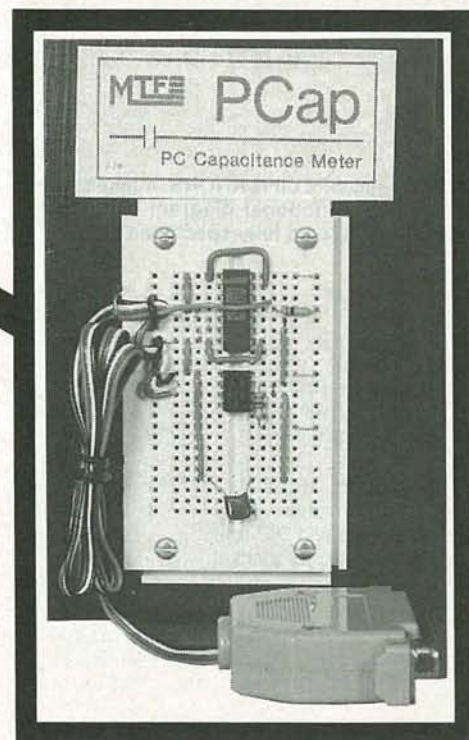

sense it. If a signal changes a short time before you sense it, you would not see the change. If you want to check for a change in input, you can create a loop that continually senses until a change occurs, or until the program has gone through the loop a specified number of times. For example, the fragment in Listing 2 checks input status on PB5 until it finds a high or has looped 500 times.

JULY 1991

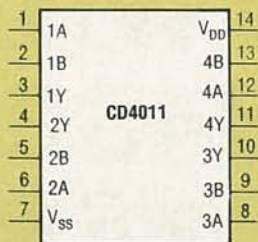

a

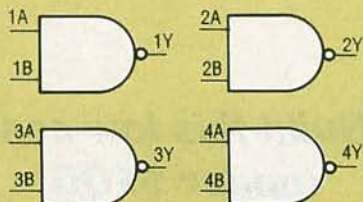

b

INPUTS		OUTPUT
A	B	Y
0	0	1
0	1	1
1	0	1
1	1	0

c

FIG. 1—IC SPECIFICATIONS. It takes a pinout (a), functional diagram (b), and a truth table (c) to fully specify an IC.

Components

- C1—0.1 μF, Mylar
- IC1—8255 PPI
- IC2—74LS138 3/8 decoder
- J1—DB-25 female D connector, chassis mount
- J2—DB-25 female D connector, right-angle PC mount
- S1—8-position DIP switch
- SO1—16-pin ZIF socket

Miscellaneous: 16-pin and 40-pin low-profile IC sockets, solderless breadboard, case, DB-25 male/male 10-foot cable, PC proto card, wire, solder, etc.

Note: The following items are available from JJ Barbarello, RD3, Box 241H, Tennent Road, Manalapan, NJ 07726: Double Sided I/O PC Board (PCIO), \$20.00; Complete kit with all parts (no programs or libraries), \$85.00; Programs on 5¼" or 3½" PC disk, \$10.00; Program and libraries on 5¼" or 3½" PC disk, \$35.00; Complete Kit with all parts, programs, and libraries, \$99.95. Programs include both BASIC and compiled versions of CHNGADR, ICSETUP, IC, and ICAUTO. Libraries include both .DEF and .DAT files for the most common TTL (74xx series) and CMOS (4xxx series) IC's. NJ residents must add 7% sales tax.

PC IC PROGRAMMING SHEET

Sheet 1 of 1

IC TYPE: CD 4011 CMOS Quad 2-In NAND Gate

REMARKS: Inputs=1,2,5,6,8,9,12,13. Outputs=3,4,10,11.

INTERCONNECTS (From ICSETUP Program):

IC: 1 2 3 4 5 6 7 8 9 10 11 12 13 14 15 16
 J1: 1 2 9 10 3 4 23 N/A N/A 5 6 11 12 7 8 25

STEP No.	IC PINS																NOTES
	1	2	3	4	5	6	7	8	9	10	11	12	13	14	15	16	
1	1		X	X						X	X						Init. X= Don't Care
2		1	X	X						X	X						
3			X	X	1					X	X						
4			X	X		1				X	X						
5			X	X			1			X	X						End Init ----- Test
6			X	X				1		X	X						
7			X	X						X	X	1					
8			X	X						X	X		1				
9	0		Hi	Lo						Lo	Lo						Hi,Lo are outputs
10	1		Lo	Lo						Lo	Lo						
11			Lo	Hi	0					Lo	Lo						
12			Lo	Lo	1					Lo	Lo						
13			Lo	Lo			0			Hi	Lo						
14			Lo	Lo			1			Lo	Lo						
15			Lo	Lo						Lo	Hi	0					
16			Lo	Lo						Lo	Lo	1					

FIG. 2—PROGRAMMING SHEET. Create a test program using a form like this for each IC you wish to test.

Tester programs

Four programs control the tester: CHNGADR, ICSETUP, IC, and ICAUTO. Starting with the simplest, CHNGADR is a short program that reads the file HWADDRESS.DAT, displays it on the screen, and then asks you for a new hardware address. It stores your answer in a four-character data file (three characters for the value of the address, and a trailing "D" to indicate that the address is in decimal).

ICSETUP allows you to identify the number of pins on the IC under test, specify each pin as an input, output, ground, or +V, and label each pin. Then ICSETUP counts the number of inputs and outputs to determine the 8255's mode (PA=In, PB=Out, PC=In; or PA=Out, PB=In, PC=Out). Then ICS-

ETUP assigns the available input and output lines to appropriate pins on the ZIF in the test fixture, and displays an interconnect list, like that shown in Table 1, which specifies which connections from the solderless breadboard go to which ZIF pins.

The program then writes your definitions and the 8255 setup information to a definition file. For example, if you specify file "4011," ICSETUP creates a file named 4011.DEF. You have to run ICSETUP only once for each type of IC; a library of definitions for common IC's is available from the author.

The program called IC uses the definition-file information to allow you to perform manual testing. You use the manual procedure to create a test file that ICAUTO can use to do all testing

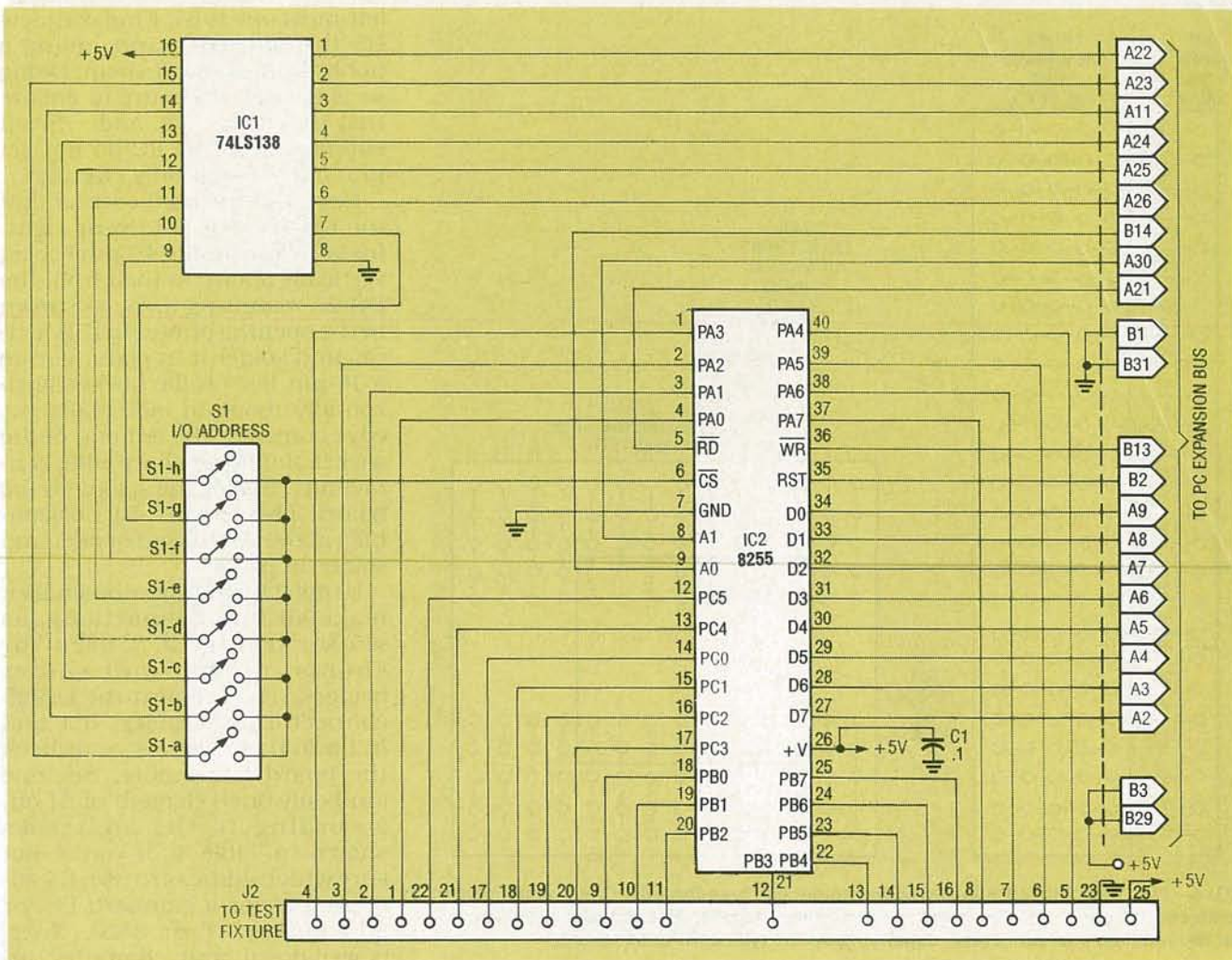

FIG. 3—THE I/O BOARD CONTAINS only two active components, an 8255 and a 74LS138. A bypass capacitor and a DIP switch round out the circuitry.

automatically. IC asks you for the name of the file, retrieves the definition information, displays an interconnect list, and then displays a graphical view of the IC under test.

Using the interconnect list, you make the connections and then insert the IC to be tested into the ZIF socket. Next you enter a pin number and a value (0 or 1). (For IC's that require a clock signal, you can specify a pulse by typing P instead of 0 or 1. A pulse reverses the state of a signal momentarily and then returns it to the original value. Only the IC's response at the end of the pulse will be stored as relevant.) The program outputs the specified value to the specified pin, reads the IC's outputs, saves the results, and displays the states of all pins on the screen.

Actually, the IC program has two phases, Initialize and Test.

During Initialize, all outputs are stored as "256," which indicates that the results are not to be considered in determining whether an IC is good or bad. When you finish initialization, you select the Test phase. Now both inputs and outputs are stored as they occur. When you finish the Test phase, you select End, at which point you can save the complete test procedure, along with the acceptable results, to a data file if you so desire. Examples of the data structure for the DEF and DAT files are shown in Tables 2 and 3, respectively.

The final program, ICAUTO, uses the DEF and DAT files to test an IC automatically. If a response is not what is specified in the DAT file, the program stops, indicates a failure, and identifies the pin where the failure occurred. Otherwise, after completing all the sequences in the DAT file, ICA-

UTO indicates Pass and requests the next IC.

Construction

The tester hardware consists of two major components: the PC-based I/O board and the test fixture. The two communicate via a standard ribbon cable with 25-pin male D connectors at both ends.

We'll begin with the I/O Board, which can be built with a prototyping PC "half-card," such as Jameco's JE417. This type of card contains an array of plated-through holes on a 0.1" grid, a mounting area for a DB-25 connector, and an edge-contact area suitable for an 8-bit PC expansion slot. Before beginning assembly, place the card in front of you with the DB-25 mounting area to your left, and the edge-contact area down. Note the 31 gold-plated edge contacts; the

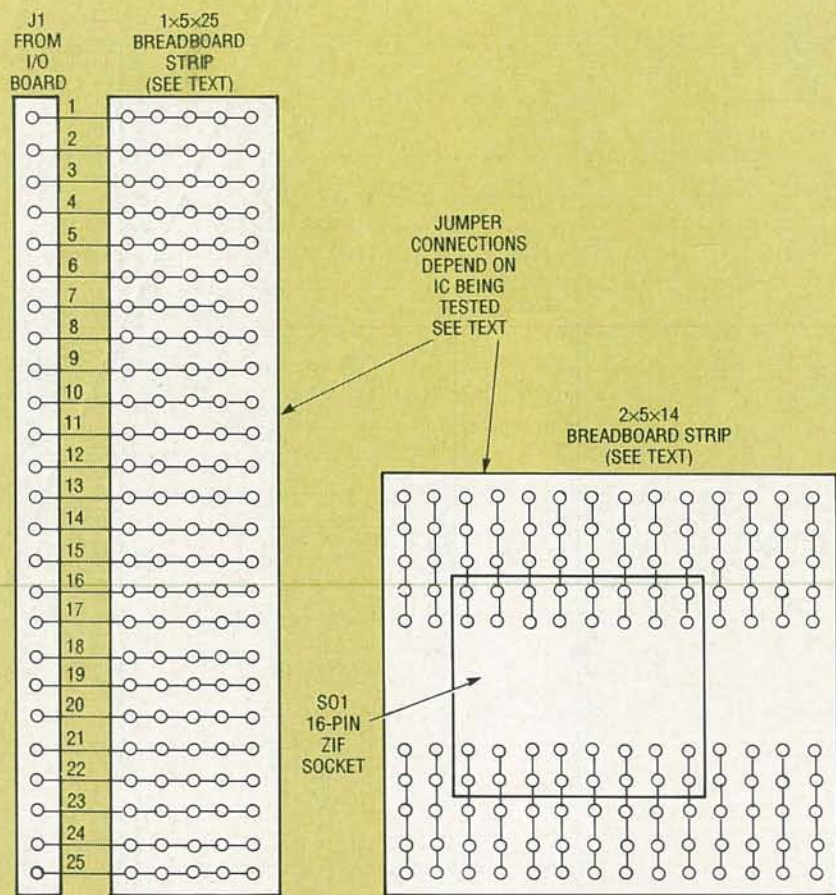

FIG. 4—THE TEST FIXTURE includes two solderless breadboards. One has permanent connections from J1; the ZIF socket is inserted into the other. The software specifies how the two must be interconnected, depending on the type of IC to be tested.

LISTING 1

```

1 REM** I/OTEST.BAS
10 CLS : PRINT : PRINT : PRINT : DEF SEG = 64
20 INPUT "Address You've Selected (ex: 640)"; A
15 B = A+1: C = B+1: D = C+1
30 OUT D, 130 : REM** PA=Output, PB=Input, PC=Output
40 OUT A, 255 : X1 = INP(A)
50 OUT A, 0 : X2 = INP(A)
60 IF (X1 <> 255) OR (X2 <> 0) THEN PRINT "Problem With PA"
70 OUT C, 255 : X1 = INP(C)
80 OUT C, 0 : X2 = INP(C)
90 IF (X1 <> 255) OR (X2 <> 0) THEN PRINT "Problem With PC"
100 OUT D, 153 : REM** PA=Input, PB=Output, PC=Input
110 OUT B, 255 : X1 = INP(B)
120 OUT B, 0 : X2 = INP(B)
130 IF (X1 <> 255) OR (X2 <> 0) THEN PRINT "Problem With PB"
135 GOTO 150
140 PRINT : PRINT TAB(25); "I/O BOARD TESTS OK AT ADDRESS";A
150 PRINT : PRINT : PRINT : END

```

LISTING 2

```

200 REM** This code checks for a high input on PB5 (J2-14)
210 REM** It assumes you've set up the 8255 by creating
215 REM** variables A,B,C,D and have performed an
220 REM** OUT D, 130 to set PB as an input register.
230 REM
240 IF (INP(B) AND 8) <> 8 THEN X=X+1 : GOTO 260
250 PRINT "High Sensed On PB5." : END
260 IF X < 500 THEN GOTO 240 : REM** Try 500 times.
270 PRINT "PB5 Remained Low During 500 Sensings." : END

```

left-most one is B1. Find contacts B5 through B10, and, using a hobby knife, remove them. Doing so is a safety measure to ensure that the +12, -12, and -5-volt supplies from the PC do not get into our +5-volt-only circuitry.

Next, flip the card over so that the DB-25 area is to your right. Install a low-profile 40-pin socket vertically about an inch from the DB-25 mounting area, as shown in the opening photos of this article, and solder it in place. Locate a 16-pin low-profile socket horizontally about an inch above the edge contacts; the left end of the socket should be above edge-contact A31. Solder the socket to the board. Then mount S1 horizontally above the 16-pin socket and solder in place.

Using 22-gauge wire or smaller, make all interconnections, as shown in Fig. 2. Check for shorts, opens, and solder bridges. Then mount the DB-25 connector. Now insert IC1 and IC2 into their sockets, and check the board once more. Set one (and only one!) element of S1 on, according to the addresses shown in Table 4. If you're not sure which address to use, try address 544 for a standard PC, or 640 for an AT or 386). Next, power down your computer, insert the card in a free slot, and power back up. *Never fiddle with the board while the PC is on.*

Enter and run I/OTEST.BAS (shown in Listing 1) using GWBASIC or BASICA. Be sure to enter the correct address when the program prompts you. If you get the message "I/O BOARD TESTS OK AT ADDRESS XXX" (where "XXX" is the address you specified with S1), you're ready to proceed. Otherwise, power down the PC, set S1 to another address, and try again.

The test fixture consists of a plastic box (any size or type will do), a DB-25 female connector, two chunks of a solderless breadboard, and a 16-pin ZIF socket for test IC's. See the opening photos of this article.

The solderless breadboard should have at least 42 rows of contacts and no power buses. Starting from one end, count down 26 rows and carefully cut the breadboard with a fine-tooth hack saw. File the end of the piece you just cut so that you end up

with a piece with 25 clean rows of contacts.

Typical breadboards have two unconnected columns of contacts separated by a "valley." Cut along the valley to create a piece with just a single column of 25 rows of five contacts. This is the block into which the 24 wires from J1 will be inserted.

From the remaining piece (with the valley), cut a section that contains 22 rows. Do not cut down the valley, because this piece will accept the ZIF socket. File the ends smooth.

Now machine the box to accept J1 and the breadboards, and drill some holes on top to pass the J1 wires. Solder 6" lengths of #22 solid wire to J1 pins 1 through 23, and pin 25. Mount J1 in the box. Locate the J1 connecting block (the one without the valley) on the box and secure it with glue or double-sided tape. Beginning with pin 1, feed each wire up through the hole and insert in row 1. Continue through pin 23. Last, feed the wire from J1, pin 25 and insert it in row 25. Note: Nothing is connected to row 24. Check continuity between J1 and the block to ensure you've connected all the leads correctly. Locate the other block (with the valley) perpendicular to the J1 block and secure it to the box. Insert the ZIF into the block. Mark the block to indicate which row is pin 1, which is pin 2, etc. Cut sixteen 6" lengths of #22 solid wire and strip 3/8" of insulation from each end of each wire. These will serve to connect the J1 block to the ZIF block.

Use

At this point you should have a board (with verified address) and a HWADDRES.DAT file indicating that address. You should also have a correctly-wired test fixture, and a cable to connect it to the board.

To create a data file for an IC, run ICSETUP. Identify the IC as either 14 or 16 pins. Then define each pin as an output or an input, and give each pin a name (six-character maximum length). Don't define the power pins yet. When finished, enter "99." Now you'll be asked to identify the GND and +V pins. When you're done, you'll be asked if you want to save this definition to a file.

**TABLE 1
SAMPLE INTERCONNECT LIST**

SO1/ZIF Socket	J1/Breadboard
1	1
2	2
3	9
4	10
5	3
6	4
7	23
8	
9	
10	5
11	6
12	11
13	12
14	7
15	8
16	25

TABLE 2—4011 DEF FILE

Rec. No.	Data	Decoded Mask
1	CD 4011, Quad	
2	2-In NAND Gate,	
3	CMOS	
4	Decoded	
5	Mask	
6	130	
7	OUT1 IN-A A**	1
8	OUT2 IN-A A**	2
9	OUT3 IN-A B**	1
10	OUT4 OUT-A B**	2
11	OUT5 OUT-B A**	4
12	OUT6 IN-B A**	8
13	N/A7 IN-B **	0
14		** 0
15		** 0
16	OUT 8IN-C A**	16
17	OUT 9IN-C A**	32
18	OUT10OUT-C B**	4
19	OUT11OUT-D B**	8
20	OUT12IN-D A**	64
21	OUT13IN-D A**	128
22	N/A14V+ **	

** Note: Encoded mask value

Answer yes and enter a descriptive name (the number of the IC, maximum eight characters), and don't include an extension.

Now get a clean programming sheet and create a test program for that IC. With the programming sheet in hand, run IC. Identify the previously specified file name. Connect the J1 and ZIF test blocks according to the interconnect list that appears on the screen. Insert a known good IC and press a key.

Execute the Initialize and Test procedures as outlined above.

TABLE 3—4011 DAT FILE

Rec. No.	PortA	PortB	PortC
1	1	256	0
2	3	256	0
3	7	256	0
4	15	256	0
5	31	256	0
6	63	256	0
7	127	256	0
8	255	256	0
9	254	1	0
10	250	3	0
11	234	7	0
12	170	15	0
13	171	14	0
14	175	12	0
15	191	8	0
16	255	0	0
17	253	1	0
18	245	3	0
19	213	7	0
20	85	15	0
21	87	14	0
22	95	12	0
23	127	8	0
24	255	0	0

TABLE 4—I/O ADDRESS

Switch Pos.	Address
S1-a	512
S1-b	544
S1-c	576
S1-d	608
S1-e	640
S1-f	672
S1-g	704
S1-h	736

When done, select End, and in response to the Save question, specify Yes. You now have the files necessary to test IC's of this type.

To test an IC, run ICAUTO. Specify a file name, connect the test blocks, insert the IC to be tested, and press a key.

As the IC is tested, you will hear a short tone as each step is performed. The bottom of the screen will report the relevant information, and the graphical representation of the IC on the screen will show how the inputs and outputs are changing. If the IC fails, the test will stop and the pin where failure occurred will be highlighted. Otherwise, the test will end and "Pass" will be indicated. Insert the next IC to be tested and press any key to continue. After testing all IC's of that type press Esc to end. **R-E**

ANALOG TO DIGITAL

```
100001111000101001011100010100
01111000011101011010001110101
011000111100010110100001110100
110010111000101001010010110100
11001011 000100110001001011
10010101110100010110101100100
110011010101001100101000001100
01010001110001010100001110101
```

```
100001111000101001011100010100
01111000011101011010001110101
011000111100010110100001110100
110010111000101001010010110100
01100101110001001110000101011
10010101110100010110101100100
110011010101001100101000001100
01010001110001010100001110101
```

DIGITAL TO ANALOG



CONVERTERS

Discover the basics of some of the most widely used D/A and A/D conversion techniques.

WE LIVE IN A WORLD OF CONTINUALLY varying analog dimensions, whether we're dealing with sight, sound, temperature, voltage, or current. Most physical and electrical parameters that we perceive change in a continuous manner, taking on an infinite number of values. Although our real-world consists mostly of analog signals, they can be difficult to manipulate. Digital signals, on the other hand, can be controlled by simple logic circuits, or by microprocessors. Complex operations can be more easily performed by digital rather than analog circuits. When digital circuits need inputs from the analog world or must output data to it, digital-to-analog (D/A) and analog-to-digital (A/D) converters become an essential interface.

We will explain some basic techniques of D/A and A/D con-

STEPHEN J. BIGELOW

version, as well as the important characteristics of certain types of approaches. We'll also show you some simple circuits with inexpensive, off-the-shelf parts you can easily build yourself.

Digital-to-analog converters

Digital-to-analog converters (DAC's) translate binary words from computers or other discrete circuitry into proportional analog-voltage levels. D/A converters can be used to drive analog devices such as meters, motor controllers, or audio circuitry. Perhaps the most dramatic example of D/A conversion is in a compact disk (CD) player. A DAC is used to convert the digital data recorded on the CD into the high-fidelity audio signal that you hear. Let's look at important D/A concepts.

The resolution of a D/A converter is the number of individual analog voltage levels that the output is capable of generating. That is directly related to the number of input bits that forms the binary word. A 4-bit DAC has 4 input bits with a resolution of 4. The number of distinct and different analog output levels the IC is capable of generating will be 2^n (2^4) or 16 levels. That means the analog output can be represented by up to 16 voltage levels. An 8-bit DAC can provide an analog output at up to 2^8 or 256 discrete levels. A 12-bit DAC can represent a digital word in 2^{12} or 4096 levels. As you can see, the more bits an A/D converter provides, the more accurately it can generate an analog signal, as shown in Fig. 1.

Settling time is the term used for the time required for the ana-

log output to stabilize after the binary input changes. It is usually specified as the time taken for the output to stabilize within $\pm \frac{1}{2}$ the least significant bit (LSB) of the expected value after the binary input changes. What that means in practical terms relates to the actual value of the LSB itself. If an 8-bit DAC has a 0 to 10-volt output range, then the LSB is worth $10/2^8$ or 0.039 volts. Half of that value is 0.0195 volts. The settling time would be the time required for the output to reach 0.0195 volts of the expected value. Settling time is typically under 10 μ s.

Accuracy is another important factor in D/A converters. In simplest terms, the accuracy of a DAC is usually specified as \pm anywhere from $\frac{1}{2}$ to 2 times the LSB. Let's consider that more closely. For a DAC with an accuracy of \pm one times the LSB, the voltage output can vary by as much as $+$ or $-$ the value of one bit. If the DAC has a 0- to 5-volt output with 12 bits of resolution, the LSB would be $5/2^{12}$ or 0.00122 volts. For any binary input, the output voltage may be higher or lower than the expected value by 0.00122 volts. If that same DAC has $\pm \frac{1}{2}$ times the LSB accuracy, an output could only deviate $\pm 0.00122/2$ or ± 0.00061 volts. The smaller an accuracy value is, the more closely the output will match the expected output.

Several methods have been developed over the years to deal with digital-to-analog conversion. We will look at two generally accepted methods: binary weighted and binary ladder D/A.

Binary-weighted resistor D/A

The binary-weighted technique is the oldest and simplest method of converting digital bits into an analog signal. For the circuit in Fig. 2, a binary word is applied to a series of gates that drive analog switches. When a binary 0000 is applied to the gates, all analog switches are open so no voltage is applied to the op-amp. The output is then 0 volts. When a binary 0001 is applied, S1 closes and -10 volts is applied to R1. Since the op-amp input represents a virtual ground, there is effectively 10 volts across the 8K resistor. That causes 10 V/8000 Ω , or

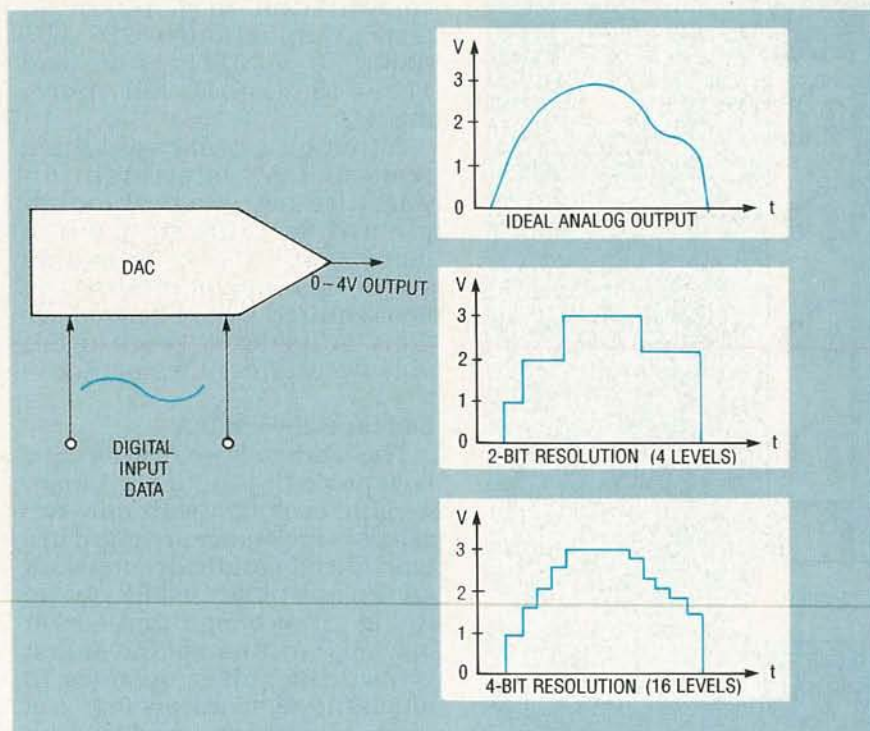

FIG. 1—FINER RESOLUTION OF THE OUTPUT VOLTAGE in a DAC is provided by using a larger number of bits.

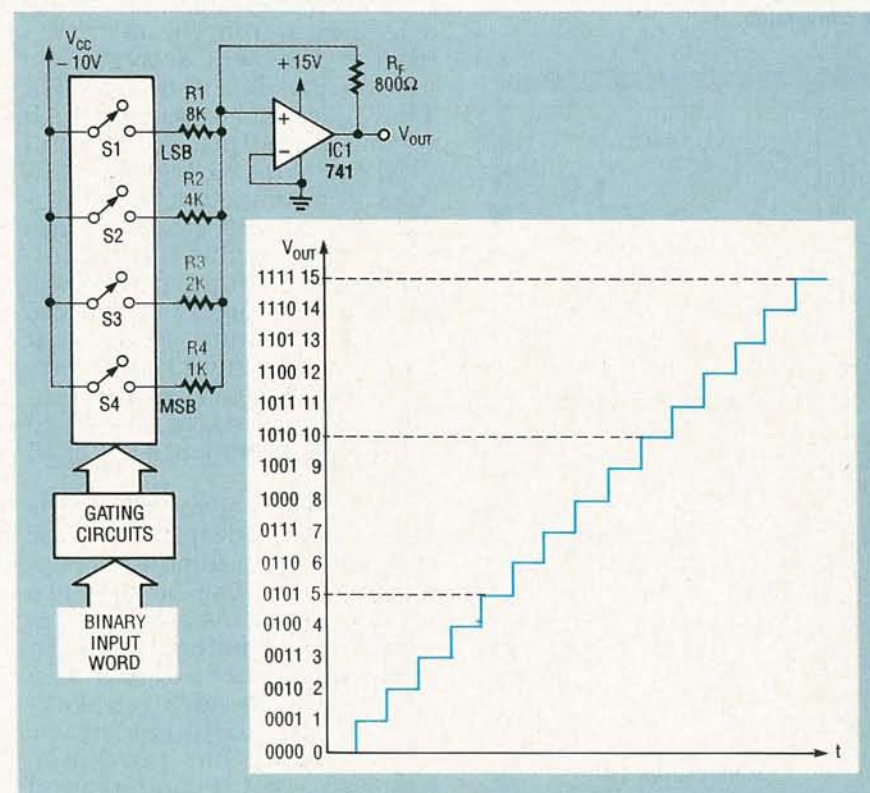

FIG. 2—A BINARY WEIGHTED D/A converter offers a simple example of basic DAC operation.

1.25 mA, to flow through the 800-ohm feedback resistor, R_F . By Ohm's law, the voltage across R_F would be 800 ohms \times 1.25 mA, or 1 volt.

When the binary word changes to 0010, S1 opens and

S2 closes. That causes 2.5 mA (10 V/4000 Ω) to flow through R2. The voltage across R_F is then 800 ohms \times 2.5 mA, or 2 volts. A binary 0100 would result in 4 volts at the output, and a binary 1000 would cause 8

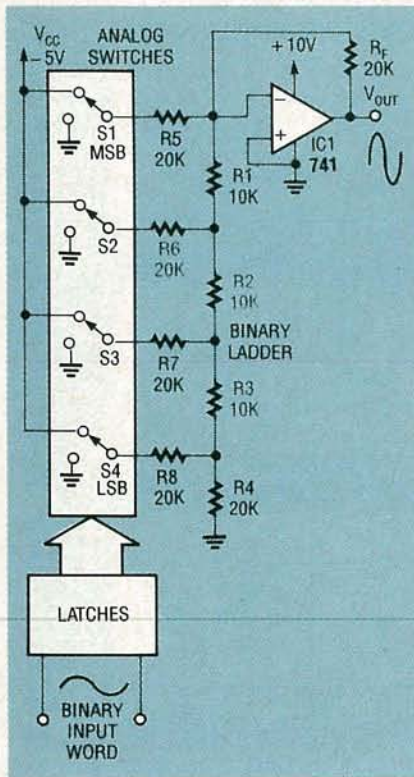

FIG. 3—A BINARY LADDER provides a simple, reliable, and accurate method of D/A conversion.

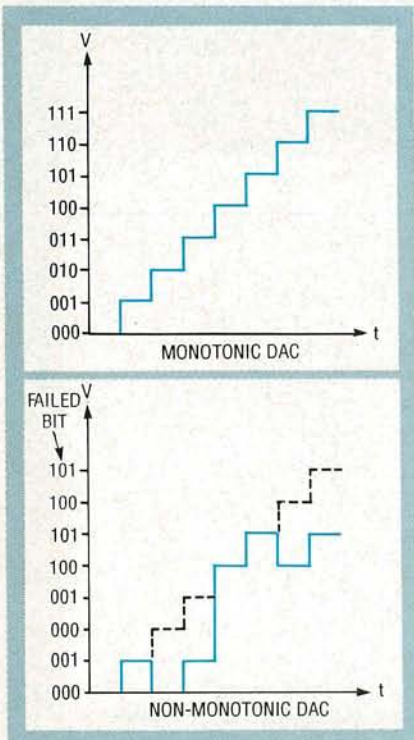

FIG. 4—A MONOTONIC DAC will reach every analog step correctly for each digital input word.

volts at the output. Notice how the value of input and feedback resistors are carefully chosen to create a binary progression. Each switch can be closed in

combination to generate an analog output from 0 to 15 volts (0000 = 0 V, 0111 = 7 V, and 1111 = 15 V) in 1 volt increments.

Although a binary-weighted resistor DAC is straightforward, it's not practical for applications requiring much more than 4 bits of resolution since the range of resistor values required would be tremendous. A ladder network needs only two values of resistance.

Ladder network D/A

The ladder-network technique is capable of producing binary weighted voltages with only two values of resistance arranged in a type of voltage-divider network known as a binary ladder, shown in Fig. 3. Although that circuit may appear intimidating at first glance, the ladder operates in much the same way as Fig. 2. A series of gates are used to drive analog switches. When a binary 0000 is sent to the gates, all analog switches are open so there is a 0-V output from the op-amp. A binary 1000 will activate the most significant bit (MSB). That closes S1 resulting in 5 volts at the output. An input of 0100 will close S2 and yield 2.5 volts at the output. A binary signal of 0010 will close S3 and place 1.25 volts at the output. And finally, an input of 0001 will close S4 to produce 0.0625 volts at the output. Notice that each output is in a binary progression. That allows the output to vary from 0 to 10 volts in 0.625-volt increments (24 or 16 steps).

The primary advantage of the binary ladder design (and the reason for its tremendous popularity) is its use of only two resistor values. As a result, it is a very simple matter to add virtually any number of bits simply by adding additional resistor "rungs" to the ladder. The binary ladder has proven so successful that it can be found as the key segment of almost every DAC manufactured today.

Binary ladders also tend to be more accurate than binary weighted circuits since it's much easier to find precision resistors in two values (such as 10K and 20K) than the many diverse values that would be re-

TERMS AND DEFINITIONS

- **Accuracy**—A figure indicating how closely the converter's output represents the input information, usually expressed as a portion of the LSB.

- **Binary Coded Decimal (BCD)**—A binary numbering system using binary codes 0 through 9 only, instead of 0 through F. That allows a closer relationship between digital data and decimal numbers.

- **Comparator**—An op-amp circuit used in ADC's to compare the analog input signal to a reference voltage.

- **Conversion Time**—An ADC term used to indicate the amount of time required for the analog input voltage to be converted to a digital word.

- **Integrator**—An op-amp circuit used in some ADC's to provide stable voltage-ramp performance for slope conversion.

- **Least Significant Bit (LSB)**—A digital bit which carries the least binary weight in the digital word.

- **Monotonicity**—A DAC term used to indicate that each analog output step will be correct for every corresponding digital input word.

- **Most Significant Bit (MSB)**—A digital bit which carries the greatest binary weight in a digital word.

- **Quantizing Error**—Error introduced into an A/D conversion when the analog input changes during the conversion cycle. The amount of error depends on the rate of signal change and the conversion time.

- **Resolution**—The number of discrete digital states (usually expressed as 2^n bits) that are used to express an analog signal.

- **Settling Time**—A DAC term used to express the amount of time required for the analog output to stabilize after the digital input has changed.

quired in a binary weighted circuit. Conventional D/A converters integrate resistors and amplifiers onto a single IC, such as Precision Monolithic's DAC-08.

Now that we've discussed the basic approaches of DAC operation, we can examine a final important specification of monotonicity. As you know, the analog output voltage of a DAC will progress in steps as the binary input word increments, as shown in Fig. 4. Ideally, each increment in the binary input will cause a known, predictable step in the output voltage. In some devices, however, the switching and amplifier components do

not allow enough current to flow under all conditions. That can cause the DAC to "skip" steps at certain bit levels. While a monotonicity problem on a low-weight bit may have little impact on the output, the effects become more significant as the weight of the bit increases. A DAC is said to be monotonic if it does not miss any steps across the entire range of binary inputs. Now let's look at more involved A/D converters.

Analog-to-digital converters

An analog-to-digital converter (ADC) is used to translate a continuous analog signal into a finite number of digital bits. The resulting digital "word" becomes the binary representation of the analog level at the moment it was converted.

The resolution of an ADC is very much like its DAC counterpart—it is the number of bits with which the ADC will represent the analog signal. An ADC with 4 bits will have a resolution of 4 bits, and can represent an analog signal with up to 2^4 or 16 binary words. An 8-bit ADC can represent an analog signal with up to 2^8 or 256 discrete words. A 12-bit ADC can represent an analog signal with as many as 2^{12} or 4096 individual binary words. You probably get the picture. The more bits of resolution by now an A/D converter can provide, the more accurately it will represent the analog signal, as shown in Fig. 5.

Conversion time is another important aspect of A/D converters. As you will see, the conversion of an analog signal into a digital word is not an event, but a precise, deliberate process. As a result, it requires some finite amount of time to sample the analog input, digitize it, then make the binary result available at the output. The conversion time is the period of time required to complete that process. It can range anywhere from microseconds (for very fast converters) to milliseconds (for slower devices). Since A/D conversion is a precise synchronized process, a clock source is also needed in most devices.

Sampling theory

Since an ADC requires a cer-

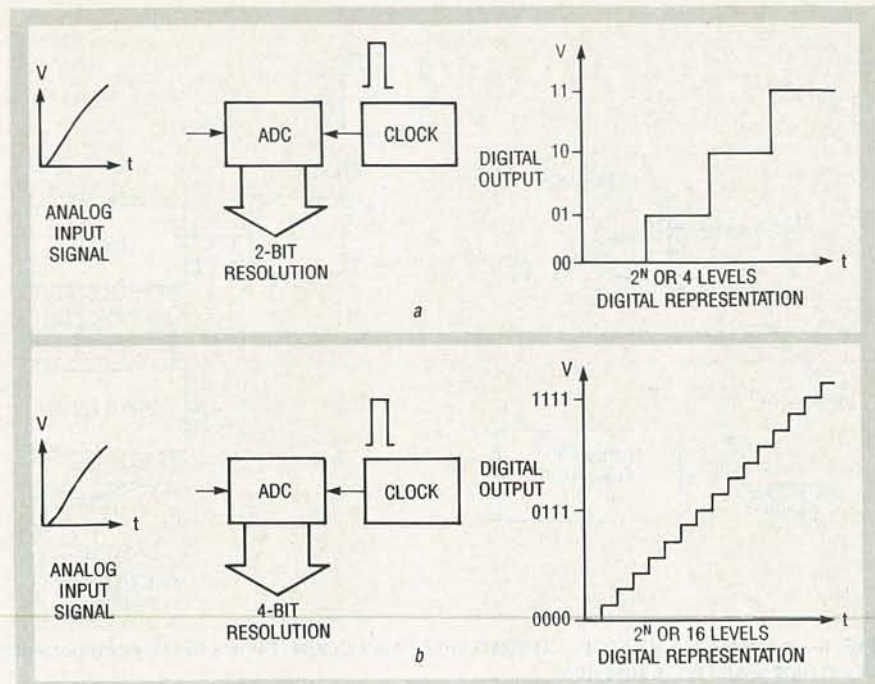

FIG. 5—THE RESOLUTION OF A/D CONVERTERS is directly affected by the number of bits.

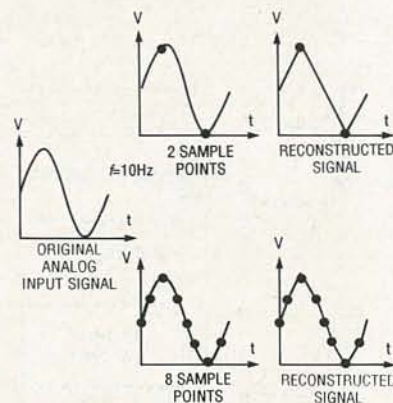
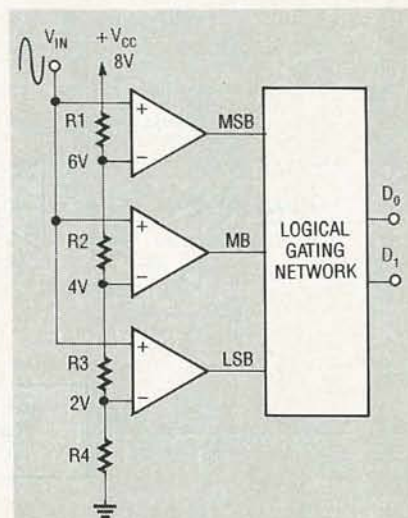

FIG. 6—THE MORE SAMPLE POINTS taken from an analog signal, the more closely a reconstructed signal will resemble the original.

tain amount of time to perform a conversion, there are only just so many samples of a signal a converter can digitize in any given time. For example, if an ADC makes one conversion in 1 ms, it could then theoretically make 1000 conversions in 1 second (1/.001 s). The maximum conversion rate is equal to the reciprocal of the conversion time.

To digitize a faithful representation of the analog input, the converter takes samples at a minimum of twice the maximum frequency component of the analog input signal. That sampling rate is also known as the Nyquist rate. Consider an analog sine wave of 10 Hz applied to an ideal ADC in



V_{IN}	BINARY OUTPUT		COMPARATOR OUTPUT		
	D_1	D_0	MSB	MB	LSB
0-2V	0	0	0	0	0
2-4V	0	1	0	0	1
4-6V	1	0	0	1	1
6-8V	1	1	1	1	1

FIG. 7—THE FLASH A/D CONVERTER offers speed and simplicity of operation at low resolutions.

Fig. 6. The minimum sampling rate is $2f$, or 20 Hz, which yields two digital-data points for each cycle. When the digital data is reconstructed by a DAC, the new analog signal bears a resemblance to the original. (A filter on the DAC output smooths

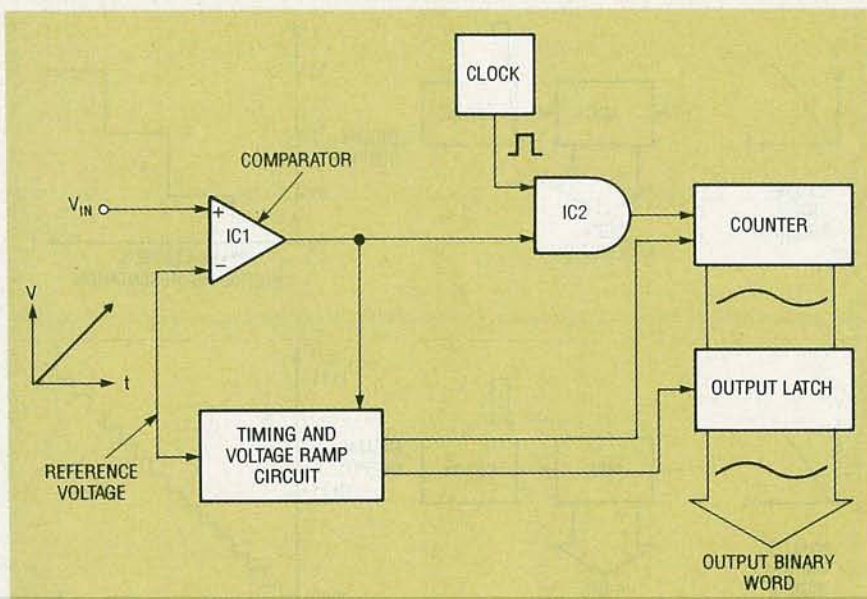

FIG. 8—A RAMP GENERATOR, COMPARATOR, AND COUNTER are the key components of a single-slope A/D converter.

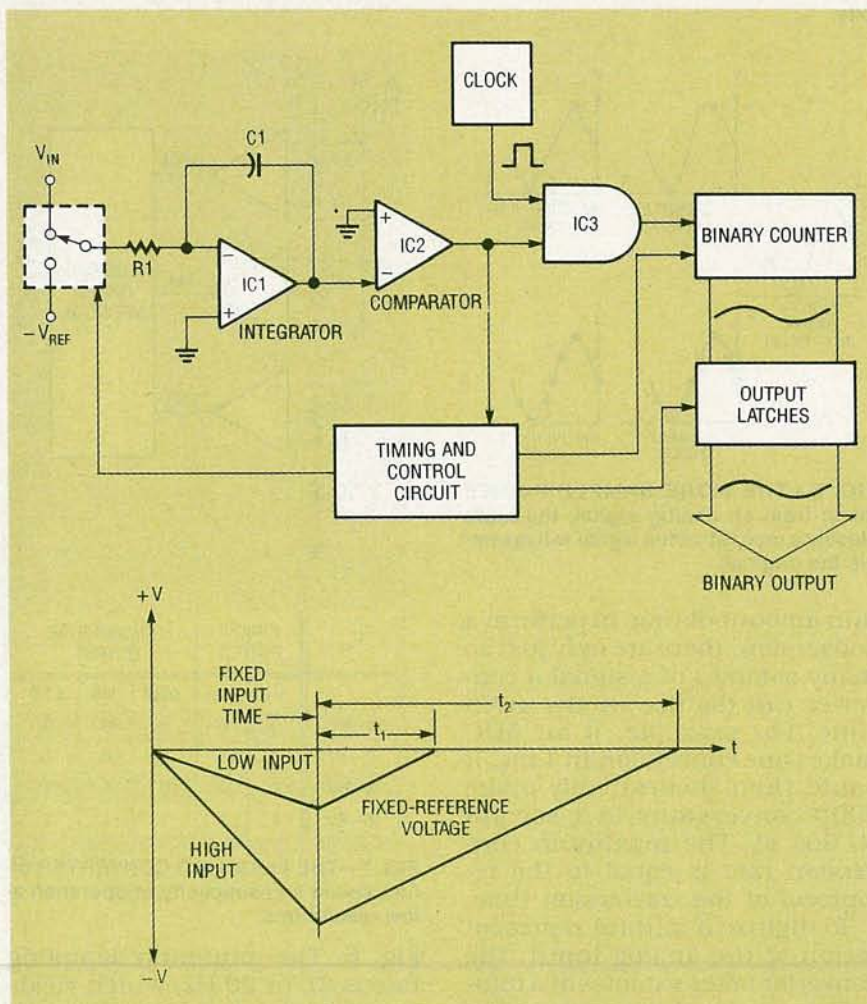

FIG. 9—A DUAL-SLOPE A/D CONVERTER provides much more stable operation than the single-slope converter.

the sharp peaks of the reconstructed signal.) If 10 Hz is the maximum frequency entering

the ADC, the maximum allowable conversion time is 1/20 Hz, or 500 ms. If the maximum input

frequency is raised to 10 kHz, the ADC needs to sample at $2f$, or 20 kHz to maintain the same two data points per cycle. That means the converter has to perform conversions in 1/20,000 Hz, or 500 μ s just to keep up with the input signal.

To improve the fidelity of the digitized signal, we could take more samples in the same period of time. A sample rate of 8 points per cycle requires a sample rate of 8 times the maximum frequency component of the input signal. An input of 10 Hz must be sampled at 80 Hz, so the converter would have to convert a point in 1/80 Hz or 12.5 ms. A 100-kHz signal needs to be sampled at 800 kHz. The ADC then converts a sample in 1/800,000 Hz, or 1.25 μ s. That is extremely fast for most A/D converters, although there are some types which can approach 1- μ s conversion times. If the ADC cannot sample fast enough to keep up with the signal, information contained in the analog input signal will be lost.

The relationship between input frequency, conversion time, and sample rate is a very important one. A variety of methods have been developed over the years to perform the digitizing of analog signals. Many are still in use today in one form or another. We will examine six of those techniques: flash, single slope, double slope, single counter, tracking counter, and successive approximation.

Flash conversion

The flash converter is the fastest type of A/D converter that is available (Fig. 7). It uses a bank of parallel comparators to process the analog input. Flash converters are also referred to as parallel converters. A series of resistors form a voltage-divider network across each comparator. The maximum input voltage that can be translated depends on the value of V_{CC} . The output signal from each comparator is either on or off, and is compatible with digital logic.

With no input voltage, the output of each comparator is logic low. As the input voltage increases, the output of each comparator will cascade high as the input exceeds each reference

voltage set by the voltage-divider network. A network of digital gates is used to convert the array of comparator signals into a binary word which is made available at the converter's output.

Our example in Fig. 7 provides only two bits of resolution. A 2-bit ADC is not very practical for most applications, but it demonstrates the key concepts needed to build a flash converter. As you may have noticed from the circuit in Fig. 7, it takes 2^{n-1} comparators to support the resolution of the converter. Our 2-bit ADC example requires $2^2 - 1$, or 3 comparators; a 4-bit converter needs $2^4 - 1$, or 15 comparators; an 8-bit flash ADC needs $2^8 - 1$, or 255 comparators, and so on. This vastly increasing complexity is a great disadvantage in flash devices—not only in the need for additional comparators, but also in the unwieldy gating circuitry as well.

The main advantage to flash converters, of course, is simple speed. Since the analog input is applied to every comparator simultaneously, the conversion time is merely equal to the propagation delay of the comparators and gating circuitry. A flash conversion can be accomplished in just a few microseconds.

Single-slope ADC

A more efficient method of A/D conversion is the single-slope A/D, also known as the single-ramp A/D (Fig. 8). In the single-slope circuit, the cycle begins with the counter reset and the ramp voltage at zero. The comparator's output at that point is low, so no clock signals are allowed to reach the counter. When an input voltage is applied to the converter, the comparator's noninverting input (+) will exceed the voltage at the inverting (-) input, so its output will be high. That will enable the AND gate, which will allow clock pulses to reach the binary counter. At the same time, a timing circuit drives the voltage ramp up, which quickly increases the reference voltage on the comparator's inverting input. When the reference-ramp voltage just exceeds the input voltage, the comparator's output falls low again. The clock pulses stop and the timing circuit latches the count at the binary

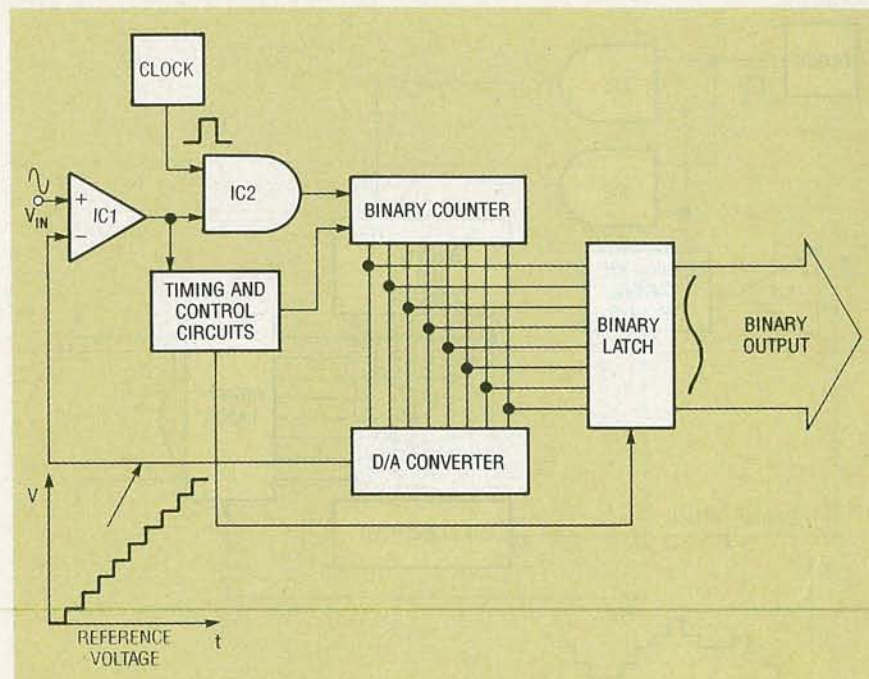

FIG. 10—A D/A CONVERTER can be used to provide the voltage ramp needed to operate a single-counter A/D converter.

counter and resets the counter for the next conversion.

The single-ramp circuit is little more than a controlled counter with a voltage-feedback loop. The circuit is timed in such a way that when the reference-ramp voltage equals the applied input voltage, the binary count existing on the counter at that moment is the digitized value of the analog signal. Note that the speed of the clock and the rate of the voltage ramp must both be set correctly for the counter to function properly.

The time required to perform a conversion will depend upon the level of the analog input. Since the counter and reference ramp both start from zero at each conversion, it will take longer to match a higher level of analog input than a low level. The sequence of operations can take place very quickly. The reference-ramp voltage can change faster than 1 volt per ms to reach the input voltage. For example, if an input of 2 volts is applied to the circuit in Fig. 8, it would take 2×1 volt/ms, which equals 2 ms for the ramp voltage to equal the input. The actual binary count after 2 ms depends on the speed of the clock. A faster clock speed will yield a higher count, and vice versa.

Since the clock can operate independent of the voltage ramp,

unique opportunities for other outputs besides straight binary become available. Some customized instrument IC's use single-slope techniques to convert an analog input directly to binary coded decimal (BCD) to drive 7-segment displays. That type of flexibility is a strong advantage. The primary disadvantage of using single-slope techniques is the tendency toward unstable operation over time. Without some form of synchronization between the clock and ramp generator, any drift in clock speed or ramp voltage performance will cause errors in the output word. That's why single-slope converters are not used in high precision applications.

Dual-slope ADC

The dual-slope conversion technique offers the advantage of conversion stability at the expense of conversion speed. The reference-ramp generator circuit eliminates the effects of component drift over time (Fig. 9).

The input signal of a dual-slope converter is fed into an integrator. When a positive input signal is applied, the integrator's output voltage ramps in the negative direction. The negative voltage forces the output of the comparator high. That in turn activates the clock input to the counter which will begin to incre-

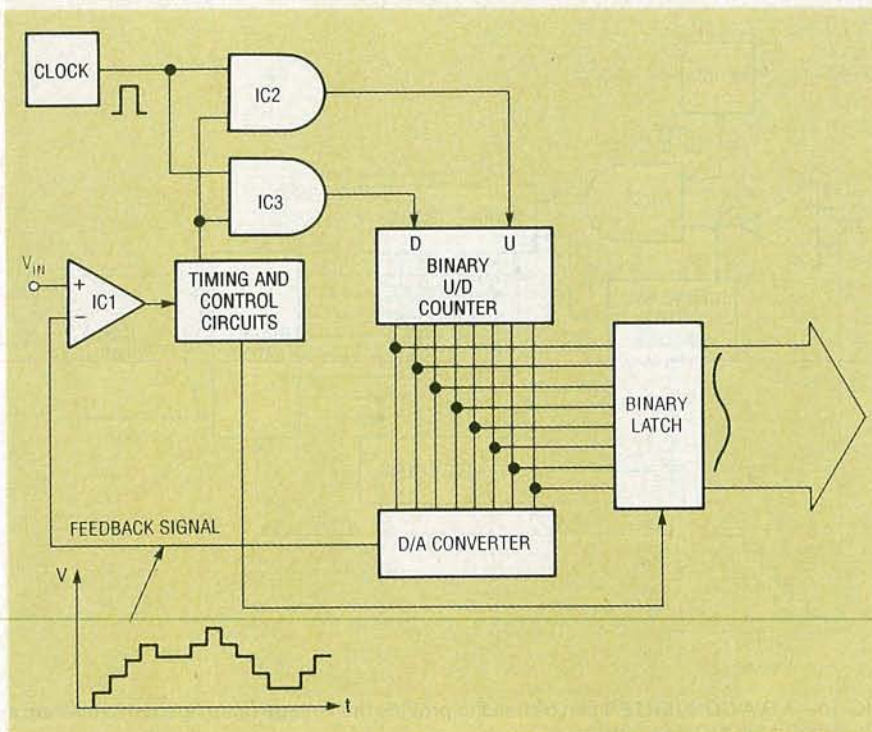

FIG. 11—A BINARY UP/DOWN COUNTER enables the A/D converter to track changes in the analog input for the tracking-counter A/D.

ment. The integrator will ramp for only a fixed period of time. After that fixed "input-time," the control circuit clears the counter and switches the converter's input to a fixed negative-reference voltage ($-V_{REF}$). With a negative voltage now applied to the integrator, its output ramps back in the positive direction. The counter begins a new series of counts until the integrator's output reaches zero. At that point, the comparator's output becomes low. That action shuts off the clock pulses to the counter. Control circuitry detects that change and latches the count to the output, then clears the counter. As with the single-slope converter, the final digital count represents the analog-input voltage.

The rate of integration depends on the magnitude of the input voltage, as well as the value of R1 and C1, so a low input voltage will reduce the integrator's output less than a high input voltage during the same fixed-input period of the conversion cycle. When a fixed negative reference voltage is applied (the values of R1 and C1 remaining constant), the time required for the integrator to return to zero is then directly proportional to the original magnitude of the input voltage. Any variations, therefore, in

the integrator circuit due to time or temperature will automatically be canceled out. That allows the dual-slope converter much more stability for high-precision applications. Similar to the single-slope technique, dual-slope converters can be used to convert the input signal directly to BCD (or any other viable code) as well as regular binary. Most quality digital voltmeters use dual-slope conversion to translate the input directly to BCD.

The disadvantage of dual-slope conversion is the extended period of time needed to make a conversion. A dual-slope converter may require more than 100 ms to translate a high input voltage.

D/A feedback converters

D/A converters may also be used to provide the reference feedback signal to the comparator. There are two basic types that we will examine: single-counter and tracking-counter types. Let's take a brief look at each one.

The single-counter A/D converter is a variation of the single-slope approach. Its operation is identical in all aspects but one—a D/A converter is used to read the count from the binary counter and provide a feedback voltage to the comparator instead of

an integrator or other voltage-ramp source (Fig. 10).

When an analog input is applied to the comparator, its output becomes high. That allows clock signals to reach a binary counter. As the counter increments, the voltage output of the DAC increases at the negative input to the comparator. When the DAC level just exceeds the input, the comparator shuts down. A control circuit latches the binary count to the output, as well as resets the counter for the next conversion.

Although single-counter conversion is a faster method than the dual-ramp approach, it does require the use of a high-precision DAC to provide a steady, accurate feedback signal to the comparator. It also requires the counter to start from zero at each conversion. That can waste a bit of time through each cycle, especially if the voltages to be converted are near their maximum levels.

The tracking-counter technique can yield conversions much faster than the single-counter. That is possible by the use of a binary up/down (U/D) counter instead of just an up counter like the ones used in our previous examples. The counter can increment or decrement depending on the state of the comparator's output. That permits the binary word to literally track the changes in the analog signal (Fig. 11).

The cycle begins with an analog signal to the comparator. The count on the binary U/D counter may be at any value. That means that the DAC feedback voltage may be greater or less than the analog input. If the feedback voltage is greater than the analog input, the comparator's output will be low and the control circuits will gate the clock pulses to the count-down input of the counter. That will decrement the binary counter's output and reduce the feedback voltage at the comparator. When feedback voltage drops below the analog input, the comparator's output will go high and control circuits will cause the binary count to latch to the output. Gating will send clock signals to the up input of the counter (which is not reset) and cause it to begin counting up

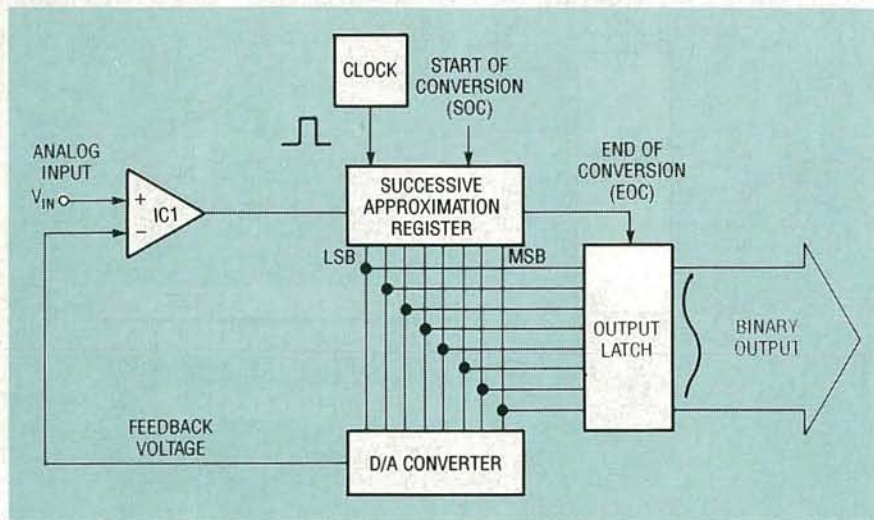

FIG. 12—A SUCCESSIVE APPROXIMATION REGISTER (SAR) speeds up the process of A/D conversion.

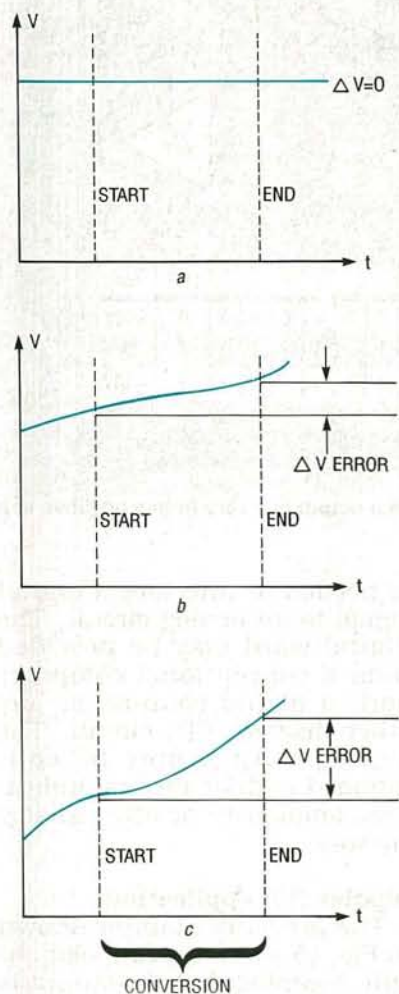

FIG. 13—QUANTIZING ERROR can enter the A/D conversion as the analog signal changes during the conversion cycle. No quantizing error exists for a DC voltage (a) because there is no change in voltage, some quantizing error occurs with low-frequency signals (b), and a higher degree of quantizing error is produced with high-frequency signals (c).

again looking for another change of state. If the input signal remains constant, the output word will tend to oscillate by $1 \times \text{LSB}$ as the converter tries to center itself. That potential oscillation problem is the greatest disadvantage of tracking-counter ADC's.

As you might imagine, this type of converter can be much faster than the single-counter technique, but it is best suited for digitizing fast-changing analog inputs. Signals which change quickly are less likely to allow the converter to oscillate.

Successive-approximation ADC

Of all the techniques that we have covered up to now, the successive approximation (SA) approach has become the technique of choice for low-cost, moderate-resolution, high-speed A/D converters. Successive approximation is a clever and powerful technique that can be used to digitize an analog signal quickly and efficiently with no os-

cillation. The process of conversion is a bit more involved than the counter techniques that we have discussed.

The heart of the SA converter is a device called the successive approximation register (SAR). This serves a very different purpose than the counters we have seen (Fig. 12).

The conversion cycle begins when an analog signal is applied to the converter and a start conversion pulse is placed on the SAR. The first clock pulse into the SAR turns on the MSB output. That in turn sets the DAC output to 50% of its voltage output. The SAR looks at the comparator's output to see if the DAC output is greater or less than the analog input. If the DAC voltage is greater, the comparator will be off, so the SAR will turn off the MSB and call it a zero. If the DAC voltage is less than the analog input, the comparator will remain on, so the SAR will leave the MSB on and call it a one. It does all of this in one clock pulse. On the next clock pulse, the SAR will turn on the second most significant bit and re-check the results from the comparator. Once again, if the new DAC signal is greater than the input voltage, the comparator output will be off, so the SAR will turn off the bit and call it zero. If the new DAC signal is less, the comparator will remain on, and the SAR will leave the bit on as a one.

The SAR will examine each bit in this fashion (MSB to LSB) until all bits have been examined. Since one bit is evaluated in one clock pulse, an 8-bit ADC will process the conversion in only 8 clock pulses. When the LSB is finally processed, the SAR will send out an end of conversion (EOC) signal which will latch the

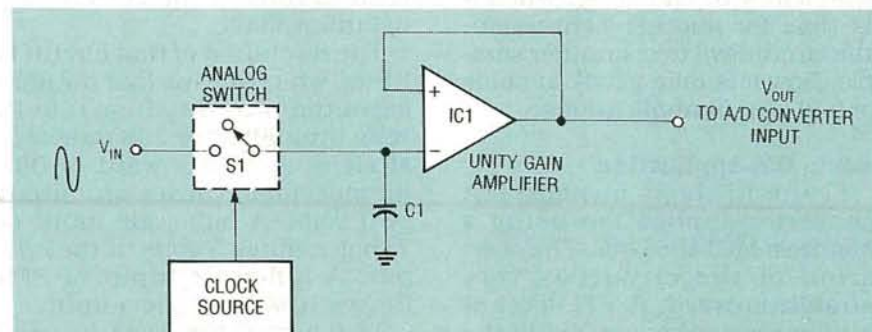

FIG. 14—A SIMPLE SAMPLE-AND-HOLD CIRCUIT can be used to eliminate the effects of quantizing error.

resulting binary word directly to the output.

Successive approximation converters are perhaps the most efficient type of A/D converters available. They are capable of extremely fast conversions at high resolutions. Many converters of this type can process 12 bits of resolution in less than 10 μ s.

Quantizing error

Now that you have a better idea of how A/D converters operate, we will discuss the characteristic of quantizing error. Quantizing error is caused by changes in the analog-input level during the conversion process.

Remember that the analog signal of an ADC is applied to a comparator. When a cycle is started, it requires some finite amount of time (microseconds to milliseconds) to produce a digital output. If the input voltage changes during the conversion, the final binary output will represent the voltage level at the end of the cycle instead of the beginning. When there is no change in input voltage, such as in a DC voltage, no quantizing error enters into the conversion, as shown in Fig. 13-a. The faster the signal change, or "slew rate," the greater the quantizing error will be (Figs. 13-b, 13-c).

One common way of avoiding quantizing error is to use a sample and hold circuit before the analog input to the comparator. Figure 14 shows such a circuit. An electronic switch is closed to take a rapid sample of the analog input signal. The sample capacitor C1 charges to the value of the input signal and the electronic switch will open. That eliminates the effects of quantizing error since the capacitor will retain the value of the analog sample regardless of how the overall analog signal may be changing. When it is time for another conversion, the circuit will take another sample. Now let's take a look at some actual circuit applications.

Basic D/A application

Figure 15 shows a simple D/A converter application using a Motorola MC1408 DAC. The operation of the circuit is very straightforward. A TTL-level 8-bit binary word is applied to the DAC inputs D_0 through D_7 .

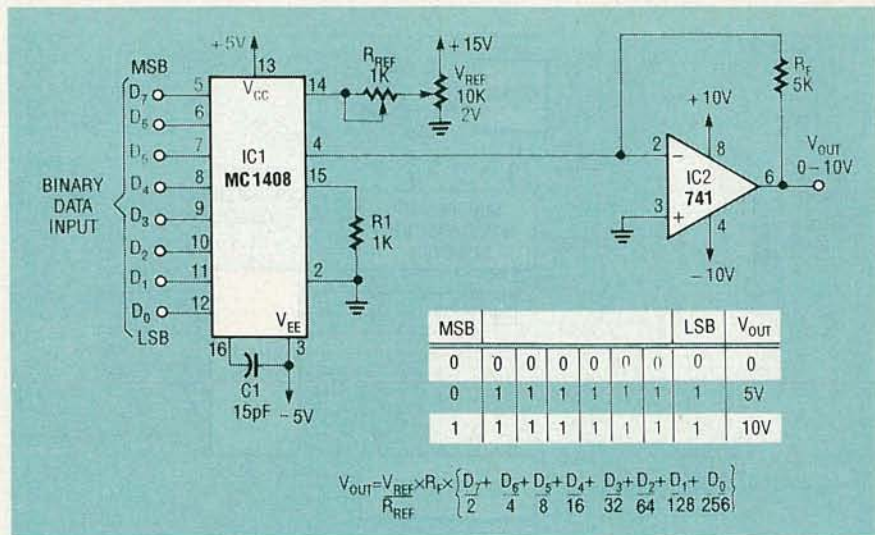

FIG. 15—A UNIPOLAR D/A application circuit. An 8-bit binary word is applied to the DAC input. A binary ladder is used in the MC1408 to translate the signal into a current output, an op-amp is then used to convert the current into a voltage signal.

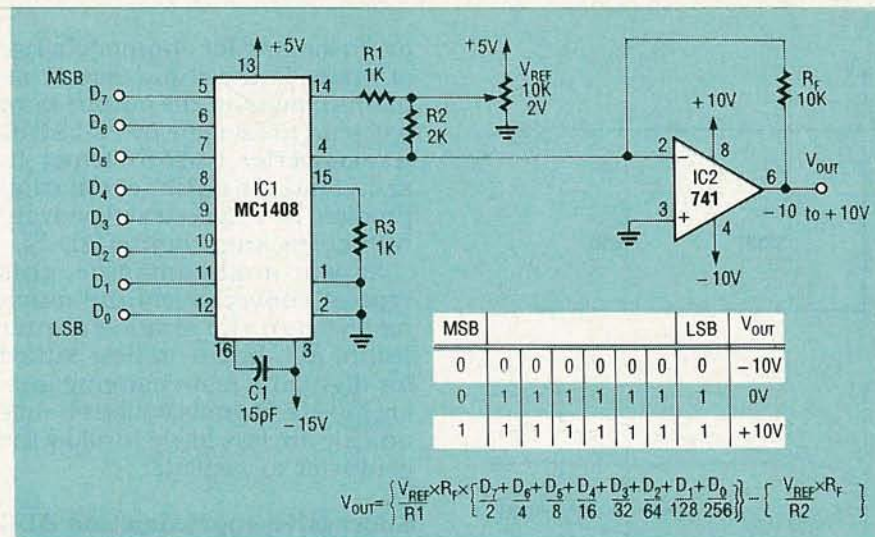

FIG. 16—IN A BIPOLAR D/A application circuit the output can vary from a negative to a positive voltage.

Since no clock or outside timing is required, the conversion takes only the settle time of the MC1408 (about 300 ns). The MC1408 uses a binary ladder to switch and translate the signal into a current output. An op-amp, such as the LM741, can be used to convert the current signal into voltage.

The resolution of that circuit is 8 bits, which means that the analog output can vary from 0 to 10 volts through 2^8 or 256 individual steps. A binary word of 00h (hexadecimal) causes an output of 0 volts. A half-scale input of 7Fh generates 5 volts at the output. A full-scale input of FFh causes 10 volts at the output.

That circuit can easily be used just about anywhere a basic DAC

is needed to interface a digital signal to an analog circuit. The digital word may be provided from a conventional computer port, a digital counter, or any other discrete TTL circuit. The analog output may be conditioned to drive meters, indicators, amplifiers, or other analog circuits.

Bipolar D/A application

The previous example shown in Fig. 15 showed a unipolar circuit, meaning that the output is only in one polarity. If a bipolar output is needed (one that varies from a negative to a positive voltage) the circuit can be changed as shown in Fig. 16.

Connecting the input of the op-amp to the reference resistor R2

TABLE 1—POPULAR 8-BIT CONVERTERS

Component	Type	Description	Resolution	Conversion Time	Settling Time	Supply Voltages	Price*
MC14433P	A/D	Dual Slope	3½ Digits	40ms	—	+5, +8	\$7.00
MC14443P	A/D	Single Slope	8 bits	300ms	—	+5, +8	\$4.00
MC14447P	A/D	Single Slope	8 bits	300ms	—	-5, +8	\$4.00
MC14559BCP	A/D	Successive Approximation	8 bits	—	—	±3 to ±18	\$7.00
ADC0803	A/D	Successive Approximation ±½ LSB	8 bits	100µs	—	+5V	\$5.00
ADC0808	A/D	Successive Approximation ±½ LSB	8 bits	100µs	—	+5V	\$5.00
ADC0809	A/D	Successive Approximation ±1 LSB	8 bits	100µs	—	+5V	\$4.00
ADC0817	A/D	Successive Approximation ±1 LSB, 16-Channel Multiplexer	8 bits	100µs	—	+5V	\$8.00
ADC0820	A/D	Flash Conversion Track/Hold Function		1.18µs	—	+5V	\$8.50
MC1408P8	D/A	Multiplying	8 bits	—	300ns	+5, -15	\$1.50
MC1408	D/A	Multiplying	8 bits	—	300ns	+5, -5 to -15	\$1.50
DAC08	D/A	High-Speed	8 bits	—	150ns	±4.5 to ±18	\$3.00
DAC0800	D/A	High-Speed Current Output	8 bits	—	100ns	±4.5 to ±18	\$3.00
DAC0808	D/A	High-Speed	8 bits	—	150ns	±4.5 to ±18	\$1.50
DAC0830	D/A	Double-Buffered Multiplying	8 bits	—	1µs	+5 to +15	\$5.00

*All prices listed are approximate. Contact your local distributor for current prices and product specifications.

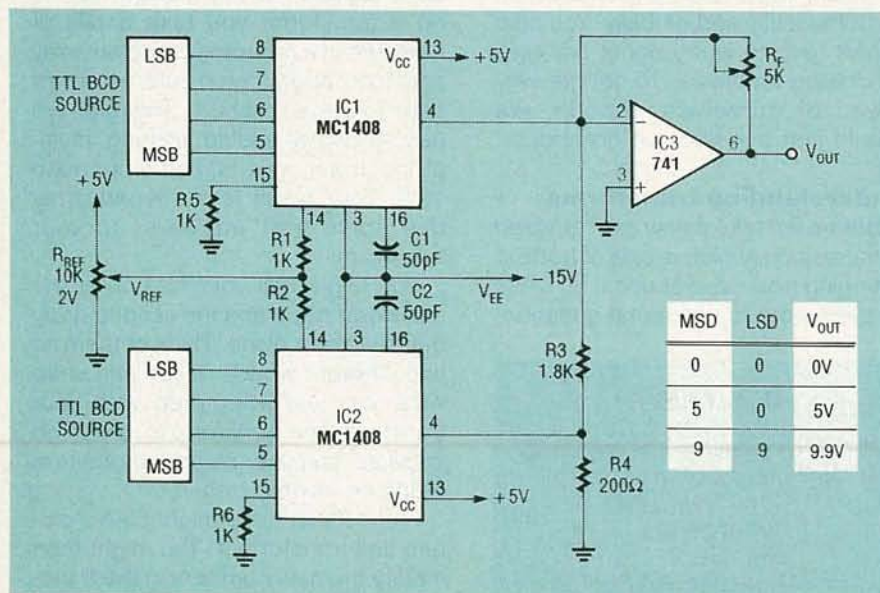

FIG. 17—A 2-DIGIT BCD-to-analog converter circuit can be made using an array of DAC's.

changes the circuit's frame of reference so that the amplifier's output will swing from -10 volts to +10 volts. In order to do that, the values of R₁, R₂, and R_F must be chosen very carefully. When a 00h is sent to the MC1408, its current output will be 0 mA, but the biasing of the op-amp will make the voltage output -10 volts. As the binary input increments to 7Fh, the analog output will rise to 0 volts. A binary word of FFh will raise the output to +10 volts.

The circuit in Fig. 16 represents a basic D/A sub-circuit. It can be used in just about any situation where 8 bits of resolution and 300 ns of settling time are appropriate, and a bipolar output is required.

continued on page 76

HARDWARE HACKER

Understanding transforms, video compression secrets, video crosshatch generator, power electronic resources, and more wavelet breakthroughs.

DON LANCASTER

I do seem to get several helpline calls each day from those of you who just "can't find" a technical paper at your local library. It's getting so bad that I am thinking of starting up a special "Couldn't find a pig in a dishpan" contest.

Pretty near all libraries provide the *Interlibrary Loan Services*, through which you can get any copy of any paper from anywhere. All you have to do is ask. There's also the UMI folks that can very quickly ship you a copy of anything from anywhere. Finally, at extra cost, you can instantly get a copy of any paper through the *Dialog Information Service* that is becoming available at most libraries.

More on research topics like these can be found in my *Incredible Secret Money Machine* and in my *Hardware Hacker III* reprints. By far the most popular helpline request these days is for...

More on wavelets

For those of you that came in late, there's a math revolution taking place that we are intently following as an ongoing subject here in *Hardware Hacker*. This involves *wavelet theory*, a profound and earth-shattering improvement on klunky old *Fourier* transformation which is *certain* to totally change just about any and all advanced electronic topics.

There's now a brand new book on wavelets that aims at becoming the "horses mouth" classic. It is known as *Wavelets* (a catchy title, eh what?), and authored by a long list of name-brand wavelet biggies that start with G. Beylkin. It is published by *Jones and Bartlett*. No, it is not easy reading. Nor is it cheap.

Meanwhile, a spunky new outfit by the name of *Aware Incorporated* is making a big splash in actual out-the-door wavelet products. They have some wavelet demo and nice simulation software that you can run on a PC, and they seem to be the first ones out the gate with new *wavelet*

transform accelerator chips. Their initial chips are intended for video compression of 512×512 images to either eight- or eleven-bit accuracy.

There seems to be several dozen new wavelet papers being released per month now, so it really is a zoo out there. The new wavelet tool is so fundamental and so important that everybody from the oil exploration geologists to cardiologists appear to be showing intense interest.

Most of these wavelet papers are, of course, totally unreadable. But to tune yourself into them, you use the *Dialog Information Service* at your local library, and zeroing in on their *Inspec*, *Compendex*, or *Mathsci* data bases. A monthly update of the latest key abstracts should cost you under \$20. While you can get the actual papers through Dialog, they are much cheaper through UMI, and cheaper still through those usual Interlibrary Loan snailmail services.

Wavelets operate by *transforming* arrays of numbers into other arrays of numbers. Unlike the classic Fourier transformations, you can simply and quickly zero in on specific portions of a transformation problem, and can do so both locally and globally. You also do not have to worry about any ugly windowing problems. To not get way ahead of ourselves, though, we should first ask how we go about...

Understanding transforms

Before we take a new look at *video compression*, which is one of hottest emerging new wavelet uses, let's ask an even more fundamental question:

NEED HELP?

Phone or write your **Hardware Hacker** questions directly to:
Don Lancaster
Synergetics
Box 809
Thatcher, AZ 85552
(602) 428-4073

Just what is a transform? Why are they so crucially important? And why are certain hardware hacking doors permanently closed to you if you do not learn to use and love transforms?

Well, a *transform* is simply finding a different way of looking at some problem. Done properly, a transform will let something "magic" happen. What kind of magic? That depends. Transforms may just change things so they appear differently; may break something down into its fundamental parts; may extract non-obvious stuff in non-obvious ways; could let you separate signals from noise; may let you do more with less; or can perform any of a number of other unique (and often unexpected) tasks.

For instance, you can either listen to music or else *transform* that music to notes-and-staff notation on a piece of paper. Aside from it being a compact way of representing a song, the sheet-music notation lets you know what is going to happen next. It also, for better or worse, standardizes the way the song is supposed to be played.

These days, most transforms are done digitally. As Fig. 1 shows us, to do a transform, you take a pile of numbers in a grouping called an *array* and then apply some rule or set of rules to these numbers. The rules will usually involve adding, shifting, multiplying, trig functions, and other math stuff. Your result is a second array that holds the "answers" to your transform.

You might call your first array the *real world plane* and the second array the *transform plane*. Think of them as two different worlds. If you can undo what you just attempted with your transform, the transform is said to be *lossless*, and your reverse process is called an *inverse transform*.

For instance, you might take a picture and transform it. You might then modify the new numbers in the transform plane to extract the edge information, to recognize patterns, count

objects, look for differences, or de-blur the image. A final inverse transformation could then give you a "new" picture which has changed in some way from the original.

One fairly simple yet extremely important transform is known as the *linear graphical transform*. The linear graphical transform is used to change the sizing, position, rotation, and shape factor of an image or other graphics object.

The *PostScript* computer language is especially adept at making both linear and nonlinear transforms. And, unlike other languages, PostScript automatically does so continuously, invisibly, and on the fly, maintaining a separate *user space* and a machine-dependent *device space*.

Figure 2 shows you a simple linear graphical transform that can convert plain lettering into isometric lettering. Let's look at some numbers. The linear graphical transform takes any point x,y in your original artwork and converts it into a new point x',y' by using these formulas:

$$x' = Ax + Cy + E$$

$$y' = Bx + Dy + F$$

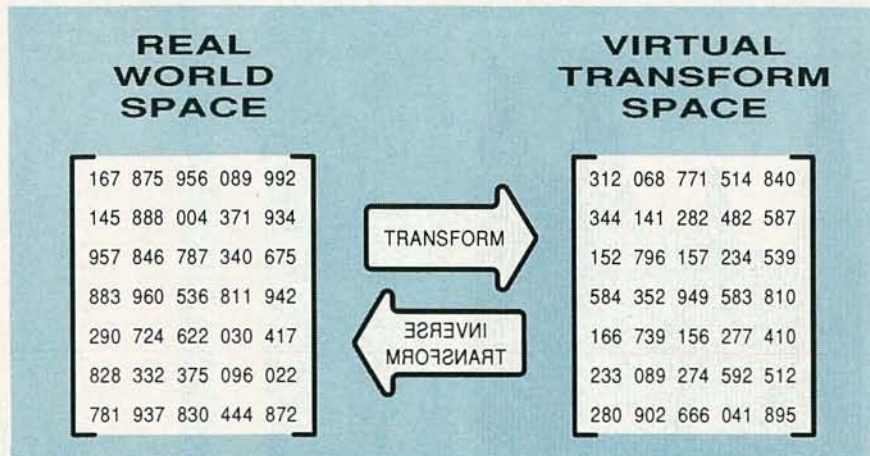

FIG. 1—A DIGITAL TRANSFORM takes an array of numbers that usually represents something from the real world. It then applies a math rule or rules to all those numbers to create a new but related array of numbers in an imaginary transform space. Certain "magic" things will happen in the transformation process that can give you elegant new ways of solving advanced electronic problems.

Values A through F are plain old constant numbers for any selected transformation. If we think of these as an array of [A B C D E F], your A value determines the *horizontal scale*. The B value decides how much *climb* you are going to get. And C decides how much *lean*. The D value sets the *vertical scale*. The E value provides for a *horizontal shift*, while the final F value sets the *vertical shift*.

For instance, you might use A and D to separately change the width and height of a font character or message. A positive C value would make your message oblique or italic, while a negative C would provide a reverse italic effect. Similarly, a positive or negative E gives you a superscript or subscript.

And a sneaky trick involving sines and cosines lets you *rotate* an image, again just by altering A through F in just the right way. Specifically, if θ is your angle of rotation, just use...

$$A = \cos\theta$$

$$B = \sin\theta$$

$$C = -\sin\theta$$

$$D = \cos\theta$$

$$E = 0$$

$$F = 0$$

It may look ugly but works like a champ. The linear graphics transform lets you translate, scale, or rotate any 2-D object any way you like.

The point here is that most other transforms work exactly the same way. You start off with some pile of numbers, apply some rules to them, and end up with a second pile of numbers. And some very good things can happen along the way.

The granddaddy transform of them all is called the *Fourier* transform, while its computer implementation is called a *Fast Fourier Transform* or one of its improved offspring. Fourier transforms move you from the real world *frequency domain* on over into the *time domain*.

As an example, if you use Fourier transforms to analyze a square wave, you will break the wave down into a fundamental sine wave and weaker third, fifth, seventh, and other odd higher harmonics. Similarly, you can take a pile of sine waves and add them together by using the inverse Fourier transform in order to get the actual square wave back.

Finding the frequencies is called *analysis*; building the waveform is known as *synthesis*.

Fourier transformation and all its newer offspring get used for nearly *all* advanced electronic applications. These include detecting earthquakes and heart attacks, robotic vision, side-looking radar, in video compression, picture deblurring, high-defini-

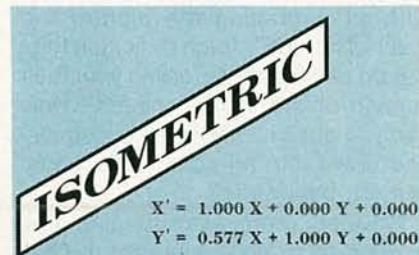

FIG. 2—THE LINEAR GRAPHICS TRANSFORM is both a simple and very important example of transform use. Here, ordinary graphics and lettering have gotten changed into isometric lettering by using the math shown.

**NEW FROM
DON LANCASTER**

HARDWARE HACKER STUFF

Hardware Hacker Reprints II or III	24.50
Midnight Engineering Reprints	16.50
Incredible Secret Money Machine	12.50
CMOS Cookbook	24.50
TTL Cookbook	19.50
Active Filter Cookbook	19.50
Micro Cookbook vol I or II	19.50
Lancaster Classics Library	109.50
Enhancing your Apple I or II	17.50
AppleWriter Cookbook	19.50
Absolute Reset IIe & IIc	19.50
Enhance I or II Companion Disk	19.50
AppleWriter CB or Assy CB Disk	24.50

POSTSCRIPT STUFF

Ask The Guru Reprints I, II or III	24.50
LaserWriter Secrets (IIe/Mac/PC)	29.50
PostScript Show & Tell	39.50
Intro to PostScript VHS Video	39.50
PostScript Beginner Stuff	39.50
PostScript Cookbook (Adobe)	16.50
PostScript Ref. Manual (Adobe)	22.50
PostScript Program Design (Adobe)	22.50
Type I Font Format (Adobe)	15.50
LaserWriter Reference (Apple)	19.50
Real World Postscript (Roth)	22.50
PostScript Visual Approach (Smith)	22.50
Thinking in PostScript (Reid)	22.50
The Whole Works (all PostScript)	299.50

FREE VOICE HELPLINE VISA/MC

SYNERGETICS
Box 809-RE
Thatcher, AZ 85552
(602) 428-4073

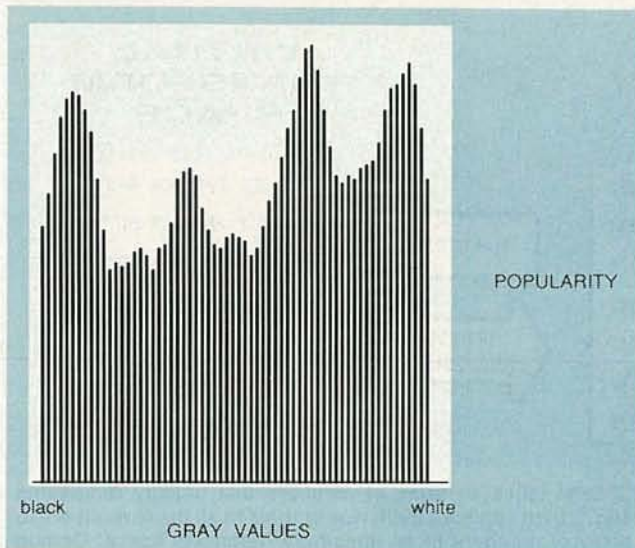

FIG. 3—A HISTOGRAM OF A TYPICAL VIDEO PICTURE shows the “popularity” of each gray level. Since no use gets made of the untransformed edge, pattern, and area info, only a very small amount of useful data compression is possible.

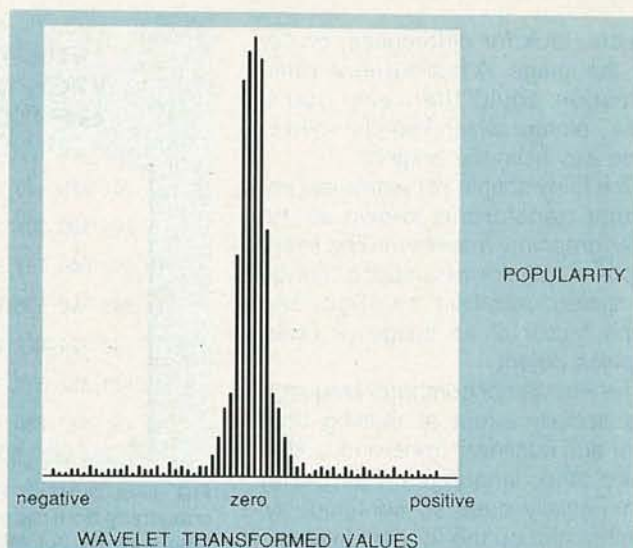

FIG. 4—WAVELET TRANSFORMED HISTOGRAM of the same picture creates a “sparse” data set having mostly zero or near-zero values by concentrating and redirecting the picture energy. Yet EVERY detail of the original picture is fully and exactly preserved! Extensive compression can now be done.

tion television, music synthesizers, sonar, geophysical exploration, holograms, spectrum analysis, machinery testing, and scads more.

As we've seen, the real excitement behind wavelets is that it does all of the things that Fourier transformation already does. Only wavelets do it far faster, far better, and much cheaper. Wavelet transformations also seem adept at localizing certain features, such as the leading and trailing edges of a square wave. Which is something that gives Fourier fits. Probably the hottest example of wavelet mania today involves...

Video compression

We are smack in the midst of a multimedia revolution that will let you directly manipulate top-quality pictures, artwork, and even superb animation on a personal computer. The big problem is to squash the information content of a high-quality color image down into a manageable space without degrading the picture too much. The HDTV (high definition television) people are grappling with their version of the same problem—How can you get all of those pixels squashed down into an acceptable transmission bandwidth?

Wavelets promise an exciting new solution to video compression. One that is fast, cheap, easily implemented in hardware, massively parallel, low on artifacts, and can give you compressions as high as 100:1.

And, what is even more exciting, it

seems that researchers in human and animal vision are freshly discovering that either the wavelets or something very much akin to them is involved in nature's way of resolving the same types of visual and aural problems. So, something really heavy seems to be coming down here.

What makes a picture different from completely random pixels? The usual answers are *edges*, *patterns*, and *large areas* where the colors and shading change little if at all. If a picture is nearly random and if you must have everything in that picture, then there isn't much you can do to squash it down to a smaller size. On the other hand, if there are lots of edges, patterns, and large areas, and if some amount of visual degradation is allowed, then you can often squash your picture down considerably, possibly as much as 100:1.

Figure 3 shows you a *histogram* of a typical image. In this case, there are 256 gray levels, and each level gets used by the height of its bar as shown. Despite your usual image having lots of edges, patterns, and big areas, the histogram looks more or less like random noise.

But, apply a wavelet transform to the same picture, and you get the surprising histogram of Fig. 4. Wavelets are chosen that zero in on extracting key edge, pattern, and area information. *The amazing result is that most of the values in your new histogram are zero and thus can be safely ignored!*

An array with lots of zeros in it is called a *sparse data set*. By going to a fancy *Huffman* or a similar coding scheme, sparse data sets can be stored or transmitted much more compactly than an array in which every value is equally important.

There is usually a two-step process involved in video compaction. You first try to concentrate your picture energy in as few array numbers as possible, zeroing out as many of the others as you can. Then you code the final results as densely as you can.

As a reminder, a wavelet transform works just like any other transform. You start off with the first pile of numbers, play several simple math games with them, and end up with the second pile of new numbers. In the wavelet case, your math games are simple additions, shifts, and rotations. Math that is far less hairy than the fancy trig needed with conventional Fourier or DCT Transforms.

There are many popular wavelets, and new ones are being discovered daily. A typical compression wavelet need act only on a very few adjacent values in your original array and can use only simple shifts and adds. The wavelets are usually applied to rows in the array, and then reapplied to the resultant columns.

So far, we have thrown nothing whatsoever away. With some sneaky coding, your *exact* picture can now be stored in one third or less the space as the original. Or modemed in one third the time or broadcast in one

third the bandwidth. And you can reverse the process at any time to get your *exact* picture back. But, we can do much better.

The eye can resolve some things quite well, and others poorly. You simply do not see some details, and others are too subtle to worry about. By zeroing out several more of the remaining numbers, and by being crude about how accurately you code the rest, you can trade off picture quality for added compression.

And your changes in quality are progressive and subtle. Instead of picking up obvious "jaggies" as you reduce your picture's information content, you simply add broadband noise to it. Which is a much more pleasant and far less noticeable form of image degradation.

There are two papers on wavelet video compression that I've found both readable and useful. The first is *Application of Compactly Supported Wavelets to Image Compression* from William Zettler and the rest of the crew at *Aware*. Free single copies are available from them on request.

Secondly, while nearly anything on wavelets by John Daugman is a good choice, his *Entropy Reduction and Decorrelation in Visual Coding by Oriented Neural Receptive Fields*, in the *IEEE Transactions on Biomedical Engineering*, volume 36, number 1, January 1989, is outstanding.

Don't let the long title scare you away on this one. It is both a good intro to wavelet video compression and a look about how nature may be already using the wavelets to solve thorny visual problems.

Should you want to explore the concept of histograms further, check out my HSTOGRAM.PS, available on *GENie* PSRT as file #146.

The compression shootout

All of this leads to an interesting dilemma. As we have seen in past issues and in the *Hardware Hacker III* reprints, the previous all-time champion video squasher is called the *Discrete Cosine Transform*. A crew known as the *Joint Photographic Experts Group* is in the final throes of making the *DCT* a standard.

You can get a free single copy of the *JPEG Technical Standard, Rev. 8* through *Adobe Systems* if you want further details. This is a "must have" document if you are at all interested in video compression.

NAMES AND NUMBERS

Active Electronics

11 Cummings Park
Woburn, MA 01801
(617) 932-4616
CIRCLE 301 ON FREE INFORMATION CARD

Adobe Systems

1585 Charleston Road
Mountain View, CA 94039
(415) 961-4400
CIRCLE 302 ON FREE INFORMATION CARD

Aware Inc

One Memorial Drive
Cambridge, MA 02142
(617) 577-1700
CIRCLE 303 ON FREE INFORMATION CARD

Dialog Information Services

3460 Hillview Avenue
Palo Alto, CA 94304
(415) 858-2700
CIRCLE 304 ON FREE INFORMATION CARD

Digital Digest

4063 N Goldenrod Road, Ste. 3
Winter Park, FL 32792
(407) 671-0185
CIRCLE 305 ON FREE INFORMATION CARD

Elector Electronics USA

PO Box 876
Peterborough, NH 03458
(603) 924-9464
CIRCLE 306 ON FREE INFORMATION CARD

GENie

401 North Washington Street
Rockville, MD 20850
(800) 638-9636
CIRCLE 307 ON FREE INFORMATION CARD

Jones & Bartlett

20 Park Plaza
Boston, MA 02116
(617) 482-3900
CIRCLE 308 ON FREE INFORMATION CARD

Kindt-Collins

12651 Elmwood Avenue
Cleveland, OH 44111
(216) 252-4122
CIRCLE 309 ON FREE INFORMATION CARD

National Semiconductor

2901 Tasman, Suite 105
Santa Clara, CA 95051
(408) 562-5900
CIRCLE 310 ON FREE INFORMATION CARD

NEC Electronics

PO Box 7241
Mountain View, CA 94039
(800) 632-3531
CIRCLE 311 ON FREE INFORMATION CARD

OKI Semiconductor

785 North Mary Avenue
Sunnyvale, CA 94086
(408) 720-1900
CIRCLE 312 ON FREE INFORMATION CARD

PC Techniques

7721 E Gray Road, Ste. 204
Scottsdale, AZ 85260
(602) 483-0192
CIRCLE 313 ON FREE INFORMATION CARD

Plessey Semiconductor

PO Box 660017
Scotts Valley, CA 95067
(408) 438-2900
CIRCLE 314 ON FREE INFORMATION CARD

RF Prototype Systems

9393 Activity Road, Ste C
San Diego, CA 92126
(800) 874-8037
CIRCLE 315 ON FREE INFORMATION CARD

RTTY Journal

9085 La Casita Avenue
Fountain Valley, CA 92708
(714) 847-5058
CIRCLE 316 ON FREE INFORMATION CARD

Shreve Systems

3804 Karen Drive
Brossier City, LA 71112
(800) 227-3971
CIRCLE 317 ON FREE INFORMATION CARD

Soft Solutions

907 River Road, Ste 98
Eugene, OR 97404
(503) 461-1136
CIRCLE 318 ON FREE INFORMATION CARD

Rolf K Taylor

RFD#1, Keeler Lane
North Salem, NY 10560
(914) 669-5421
CIRCLE 319 ON FREE INFORMATION CARD

UMI

300 North Zeeb Road
Ann Arbor, MI 48106
(800) 521-3044
CIRCLE 320 ON FREE INFORMATION CARD

At any rate, an awful lot of people have spent an awful lot of time and money to make the *DCT* a major new video-compression standard. Even PostScript Level II now has built-in *DCT* filters, and dozens of firms are offering or about to offer *DCT* compression solutions.

The only little problem here is that the wavelet transforms pass the *DCT* like it was sitting up on blocks. It appears that anything that the *DCT* can handle, wavelets can do faster, cheaper, better, and with far fewer objectionable artifacts.

In particular, there are background

POWER ELECTRONICS RESOURCES

Asea Brown Boveri

1460 Livingston Avenue
North Brunswick, NJ 08902
(201) 932-6000
CIRCLE 321 ON FREE INFORMATION CARD

C & H Sales

2176 East Colorado Blvd
Pasadena, CA 91107
(213) 681-4925
CIRCLE 322 ON FREE INFORMATION CARD

Fair Radio Sales

PO Box 1105
Lima, OH 45802
(419) 227-6573
CIRCLE 323 ON FREE INFORMATION CARD

Galco

26010 Pinehurst Drive
Madison Heights, MI 48071
(800) 521-1615
CIRCLE 324 ON FREE INFORMATION CARD

Herbach & Rademan

401 East Erie Avenue
Philadelphia, PA 19134
(215) 426-1700
CIRCLE 325 ON FREE INFORMATION CARD

International Rectifier

233 Kansas Street
El Segundo, CA 90245
(213) 772-2000
CIRCLE 326 ON FREE INFORMATION CARD

Motion

Box 6430
Orange, CA 92613
(714) 974-0200
CIRCLE 327 ON FREE INFORMATION CARD

Motion Control

800 Roosevelt Road, Ste E-408
Glen Ellyn, IL 60137
(708) 469-3373
CIRCLE 328 ON FREE INFORMATION CARD

Motorola

5005 East McDowell Road
Phoenix, AZ 85008
(800) 441-2447
CIRCLE 329 ON FREE INFORMATION CARD

NASA Tech Briefs

41 East 42nd Street, Ste 921
New York, NY 10017
(212) 490-3999
CIRCLE 330 ON FREE INFORMATION CARD

PCIM

2472 Eastman Avenue, Ste 33-34
Ventura, CA 93003
(805) 658-0933
CIRCLE 331 ON FREE INFORMATION CARD

Powerex

Hillis Street
Youngwood, PA 15697
(412) 925-7272
CIRCLE 332 ON FREE INFORMATION CARD

Power Semiconductor

600 West John Street
Hicksville, NY 11802
(516) 933-3000
CIRCLE 333 ON FREE INFORMATION CARD

Semikron

PO Box 66
Hudson, NH 03051
(603) 883-8102
CIRCLE 334 ON FREE INFORMATION CARD

SGS

1000 East Bell Road
Phoenix, AZ 85022
(602) 867-6259
CIRCLE 335 ON FREE INFORMATION CARD

Siemens

2191 Laurelwood Road
Santa Clara, CA 95054
(408) 980-4500
CIRCLE 336 ON FREE INFORMATION CARD

Surplus Traders

Winters Lane, Box 276
Alburg, VT 05440
(514) 739-9328
CIRCLE 337 ON FREE INFORMATION CARD

Teccor Electronics

1801 Hurd Drive
Irving, TX 75038
(214) 580-1515
CIRCLE 338 ON FREE INFORMATION CARD

water to the ongoing solid-state electronics revolution.

As our resource sidebar for this month, I've tried to gather together some sources for all the "Big Mutha" semiconductors and related parts. That's stuff you might be getting into if you are now experimenting with electric vehicles, machine-tool controls, AC variable-speed motor drives, welders, industrial controls, and similar high-power goodies.

An old line distributor by the name of *Galco* does seem to be the best one-stop source for power semiconductors. Their *Galco Gazette* is free, while their 1500-page main catalog is a refundable \$15.

A few of the many insider trade journals addressing power electronics include *PCIM*, *Motion*, *NASA Tech Briefs*, and *Motion Control*.

Hacker surplus power electronics seems catch-as-catch-can. But you can try *Fair Radio Sales*, *C&H Sales*, *Surplus Traders*, or else *Herbach and Rademan*.

Several of the more important manufacturers of the higher power semiconductors and support products include *Asea Brown Boveri*, *Siemens*, *Powerex*, *Power Semiconductor*, *SGS*, *Plessey*, *International Rectifier*, *Motorola*, *Teccor*, and *Semikron*. Most of them have extensive data books and application notes available.

Once again, I have a hollow feeling that I missed something obvious or important on this list. For one of our usual contests, just tell me about it.

Dot and bar generator

Plessey Semiconductors has just revised a bunch of great data books, including their *Power Control IC Handbook* and their *Satellite Cable and TV IC Handbook*. That revised gem is chock full of all sorts of goodies ranging from infrared remote controls to teletext, synthesizers, and satellite downlink chips.

One of their other chips you may find of interest is their ZNA234E TV pattern generator. The chip generates monochrome video patterns including dots, vertical lines, horizontal lines, crosshatch, or gray scale, and runs off a single +5-volt DC supply.

Figure 5 shows a typical circuit. A crystal frequency of 2.520 MHz is required for a 525-line NTSC output. An external RF modulator could be added for antenna-driven test needs.

"tiling" effects using the DCT, but none using wavelets. Your wavelet transform computations are quite simple, and much easier to realize in standard or near-standard hardware. Wavelets are also good at building up the "big lumps" first, followed by finer detail. That gets important in animation or a rapidly changing video scene.

So, I guess we are going to shortly see the answer to the question "What happens when a bunch of

people spend lots of time and effort creating a new standard that is clearly and ludicrously obsolete before the ink on the final version is dry?" Stay tuned on this one.

Power electronics resources

Where can you go to pick up a replacement 3000 amp, 2000-volt SCR for your locomotive? The answers to questions like that one involve *power electronics*, a somewhat arcane and rather specialized back-

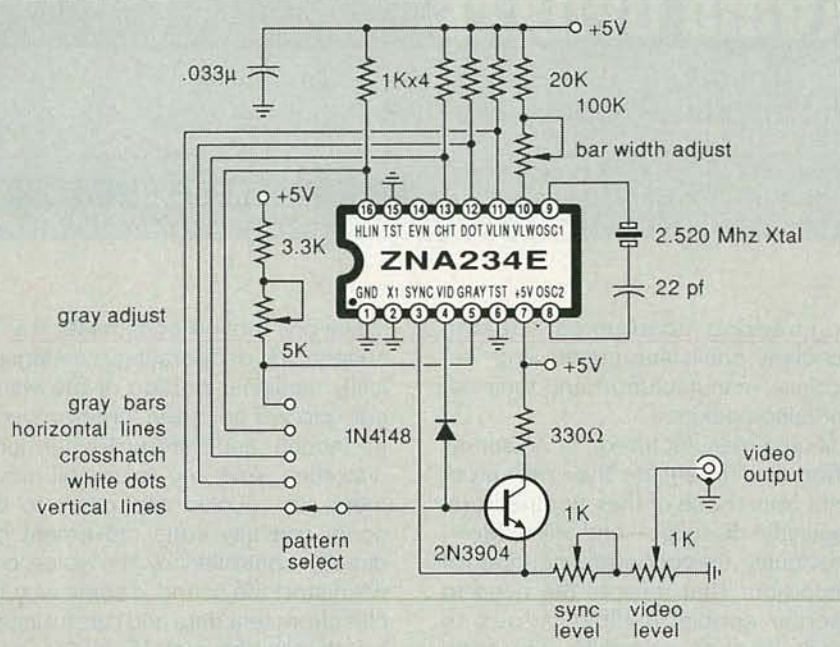

FIG. 5—A MONOCHROME TV pattern generator using the Plessey ZNA234E generates sync, blanking, gray bars, lines, dots, and crosshatch patterns.

This appears to be an older bipolar chip, since the supply current is an appallingly high 135 milliamperes. Yes, full interlace is provided. Let me know what new uses you can come up with for this chip.

New tech literature

There's a major new data book from *NEC Electronics on Infrared Remote Control IC's*. And another one on *Voice Synthesis LSI* obtainable from *OKI Semiconductor*. From *National Semiconductor*, a new *Guide to Video Products*. And for general low-cost hacker hardware, a 1991 *Active Electronics* catalog.

One good source of Mac repair parts and service information is *Soft Solutions*, while *Rolf Taylor* offers Apple II repairs. Exchange parts for both families are available through *Shreve Systems*.

A new line of ultra-high-quality fully professional RF ground plane breadboards is available from *RF Prototype Systems*.

For a rather unusual mechanical resource *Kindt-Collins* offers all sorts of industrial waxes you can use for machining, CAD/CAM, mold making, investment casting, protection, and similar needs. Even water-soluble waxes are offered.

A pair of wildly different ongoing hacker magazines that are going great guns are *Elector USA*, chock full of hands-on construction proj-

ects, many with a European or continental bent; and *Jeff Duntemann's* really great *PC Techniques*, an intense software and hardware computing resource.

Two newsletters of interest to any of you digital ham radio types include *Digital Digest* and *RTTY Journal*.

If you are at all interested in the PostScript language, do start out with my *LaserWriter Secrets* book/disk combo, Adobe's "blue" *PostScript Cookbook*, or their "red" *PostScript Reference Manual II*. All three are available through my *Synergetics*, or ordered via *GEnie PSRT* email.

We also now have the *Hardware Hacker III* and *Midnight Engineering I* reprints available, which have the latest and best of all these columns in them. All edited, revised, corrected, and indexed.

Finally, I do have a new and free mailer for you which includes dozens of insider hardware-hacking secret resources. Write or call for info.

Our usual reminder here that most of the items that have been mentioned in this column appear either in the *Names and Numbers* or in the *Power Electronics* sidebars.

As always, this is your column and you can get technical help and off-the-wall networking per that *Need Help?* box. The best calling times are weekdays 8-5, *Mountain Standard Time*. Let's hear from you. **R-E**

Safety, Security, Convenience, Entertainment and Energy Management

Home Automation from Heath, the catalog that has it all...

Enter the world of Home Automation. Remote lighting and appliance controls. Security alarms and lighting. Automated thermostats. Video monitoring systems. Whole-house security systems. They're all yours in the Heath Home Automation Catalog. To receive your FREE copy, call today toll-free.

1-800-44-HEATH
(1-800-444-3284)



Heath Company

Marketing Dept. 020-070
Benton Harbor, MI 49022

CL-807R1

CIRCLE 86 ON FREE INFORMATION CARD

JULY 1991

AUDIO UPDATE

A Distortion Primer—Part 2

LARRY KLEIN

The most well-known of the “non-standard” distortions—transient intermodulation (TIM)—achieved prominence in the early 1970’s, mostly through the work of Matti Ojala, a Finnish engineering researcher. He rediscovered that under certain conditions, amplifiers using high levels of overall output-to-input (or *global*) negative feedback would experience input overload even though the applied signal was theoretically too small to cause such a problem. I say *rediscovered*, because the effect had been documented, discussed, and solutions outlined in the early 1950’s.

In a nutshell, the TIM story is this: A rapidly changing audio signal—meaning one with high-frequency components—would overdrive a feedback amplifier’s input stage, while a signal of the same amplitude, but without high frequencies, would go through without problems. The overload occurred because the amp’s input stage parameters assumed operation with the gain reduction of negative feedback, but the feedback signal did not get back to the input fast enough to prevent overload. A basic solution to TIM is to design for sufficient amplifier bandwidth—*before* feedback—to ensure that high-frequency signals can *slew* (travel fast enough) through the amplifier to avoid problems. Today, competent engineers can easily achieve adequate slew rate—and thereby forestall TIM—without really straining very much of their design talents.

Marketing esoteric distortions

If, as I (and others) claim, the distortion problem is essentially trivial in today’s amplifiers, why all the technical papers and amplifier advertisements touting recently invented/discovered varieties of distortions and their cures? As far as I can tell, TIM and other similar obscure amplifier problems appeal to two groups:

engineering academics seeking scholarly publishing credits and, especially, manufacturers and their advertising agencies.

Audio manufacturers, in an annual effort to differentiate their new products from those of their competitors, regularly discover—and eliminate—previously unrecognized sources of distortion. That reflects the need to ascribe special audible virtues to products that are really very good but, in truth, are no better than those of their competitors. If sales of a manufacturer’s latest models can be enhanced by incorporating a newly developed lateral-feedback circuit to eliminate recently discovered problems of side-slip distortion, why not go for it!

In regard to those dedicated listeners who continue to hear problems or special desirable qualities in certain amplifiers, I would be willing to bet an extremely expensive set of diamond-encrusted tweeter cones that what they are hearing, for better or worse, has far more to do with minor frequency-response deviations than with any kind of old, new, or yet-to-be-discovered amplifier distortion mechanism.

Loudspeaker distortion

No one argues that loudspeakers are anywhere as distortion-free as amplifiers. In essence, a loudspeaker system is required to convert the electrical audio waveform supplied by an amplifier into an analogous three-dimensional acoustic waveform. Considering that loudspeakers do their jobs using an assortment of driven diaphragms vibrating in special boxes, the wonder (as someone once said of a chess-playing dog) is not that it does it well, but that it can do it at all!

The basic loudspeaker problem is linearity of transduction. That means that the speaker cone (and the voice coil that drives it) must move in exact accord with the audio input signal.

Voice-coil motion constrained by its suspension or operating in a magnetically nonlinear portion of the voice-coil gap will generate large amounts of second- and third-order harmonic distortion. And any voice-coil movement not coupled accurately to the cone, and any cone movement not directly controlled by the voice coil, will distort the sound in some way. It’s clear from test data and careful listening that in the last 15 to 20 years driver design and performance have improved dramatically.

Assessing distortion

About 15 years ago, I found myself on a business trip in England visiting the Rank HiFi speaker research and manufacturing facility. An unexpected bonus of my visit was a day-long meeting with Dr. Peter Fryer, who was then deep into an investigation of speaker distortion and all its ramifications. One of his primary objectives was to assess the audibility of the types and levels of distortion commonly produced by loudspeakers.

Since IM distortion, as mentioned last month, is generally thought of as one of the worst culprits in making things sound bad, Fryer tackled it first. A distortion generator was built that could be set to inject a calibrated amount of IM ranging from 0.1% to 10%. A virtually distortionless amplifier and speaker system were designed and built and served as the “test bed” for all of the subsequent experiments.

Much to everyone’s surprise, it was necessary to crank up the IM level to 5% or 6% before it became audible on typical complex musical material, rock or classical. With simpler music, such as a solo piano, 2% IM was clearly audible. And, when sine waves were used as the test signals, IM levels of 0.1 percent could be detected under carefully controlled conditions. None of that surprised me, since the findings neatly replicated the results of some ampli-

fier IM tests that I had been involved in four years earlier.

Fryer's next series of tests involved kinds of distortion *not* found in amplifiers. *Delayed resonance* was something that had concerned the British for years, but to my knowledge was never an issue among U.S. speaker designers. Simply described, it is the tendency of parts of a driver's cone assembly to store energy and continue to release it for some milliseconds after the original signal has ceased. It was described to me (you'll have to imagine the British accent) as "the speaker carrying on broadcasting long after the program has finished."

Unlike IM tests, the delayed-resonance research results were not easily summarized in numerical form. A basic finding was that broad low-Q resonances were far more audible than sharper peaks covering narrower bands, probably because the low-Q resonances were activated for a greater proportion of the signal. When the peak is very broad and low (a Q of less than 1), the audible effect is simply an increase in level over the affected portion of the frequency band.

The primary finding of the research was that it behooves the speaker-driver (and speaker-system) designer to eliminate resonances whenever possible, a task that has been significantly facilitated in the past decade by laser analysis of cone movement and modal vibration analysis of speaker-cabinet walls.

Doppler distortion

A distortion that excites partisan bickering among speaker-system designers, *Doppler distortion* occurs when a cone is undergoing large low-frequency excursions while simultaneously reproducing high frequencies. The theory is that the high frequencies reaching the listener's ears will be alternately compressed and stretched by the low-frequency movements of the cone. There is no question that speakers do produce Doppler distortion. The real question is: How audible is it under normal playing conditions?

A Doppler distortion generator was developed using a delay line that could be varied at a rate determined by a low-frequency signal. A total voice-coil movement of more than two inches could be simulated, cer-

tainly more than enough to simulate any real-world condition. Fryer summarized the results of days of experiments by saying that, with the possible exception of small full-range speakers (such as are found in portable radios), normal loudspeaker systems used in the home will never produce enough Doppler distortion for it to be audible.

The bottom line

As with amplifiers, most of what we hear going wrong in hi-fi speakers is in the frequency domain. However, straightening out an amplifier's frequency response is duck soup compared to the task facing a speaker designer. If an amplifier's response has a bump or a dip, a few resistors and capacitors will usually flatten it nicely. Speaker frequency response, on the other hand, involves manipulating magnetic, mechanical, and acoustic variables, in addition to the electronics of the crossover network. But improved materials and know-how continue to make the task immeasurably easier. And anyone who has done any comparison listening in the past dozen years knows that speakers continue to improve. **R-E**

Earn Your B.S. Degree in ELECTRONICS or COMPUTERS



By Studying at Home

Grantham College of Engineering, now in our 41st year, is highly experienced in "distance education"—teaching by correspondence—through printed materials, computer materials, fax, and phone.

No commuting to class. Study at your own pace, while continuing on your present job. Learn from easy-to-understand but complete and thorough lesson materials, with additional help from our instructors.

Our Computer B.S. Degree Program includes courses in the BASIC, PASCAL, and C languages — as well as Assembly Language, MS DOS, CADD, and more.

Our Electronics B.S. Degree Program includes courses in Solid-State Circuit Analysis and Design, Control Systems, Robotics, Analog/Digital Communications, and more.

An important part of being prepared to *move up* is holding the right college degree, and the absolutely necessary part is knowing your field. Grantham can help you both ways—to learn more and to earn your degree in the process.

Write or phone for our free catalog. Toll free, 1-800-955-2527, or see mailing address below.

Accredited by
the Accrediting Commission of the
National Home Study Council

GRANTHAM
College of Engineering
Grantham College Road
Slidell, LA 70460

JULY 1991

Save on cable rental fees!

**CABLE TV
DESCRAMBLERS
WE'LL BEAT
ANY PRICE!**

CALL TOLL-FREE 1-800
284-8432

JERROLD-TOCOM-ZENITH
HAMLIN-OAK-PIONEER
SCIENTIFIC ATLANTIC

- 24 HOUR SHIPMENTS!
- MONEY BACK GUARANTEE!
- FREE CATALOG & INFO!
- QUANTITY DISCOUNTS!

MASTER CARD / AMEX / VISA / C.O.D.



Have make and model number of
equipment used in your area ready

1-800-284-8432

CABLE WAREHOUSE

4700 N. HIATUS ROAD, SUNRISE, FLA. 33351

NO FLORIDA SALES

CIRCLE 189 ON FREE INFORMATION CARD

R-E Engineering Admart

Rates: Ads are 2 1/4" x 2 7/8". One insertion \$995 each. Six insertions \$950 each. Twelve insertions \$925 each. Closing date same as regular rate card. Send order with remittance to Engineering Admart, Radio-Electronics Magazine, 500-B Bi-County Blvd., Farmingdale, NY 11735. Direct telephone inquiries to Arline Fishman, area code-1-516-293-3000. FAX 1-516-293-3115. Only 100% Engineering ads are accepted for this Admart.

FCC LICENSE PREPARATION

The FCC has revised and updated the commercial license exam. The NEW EXAM covers updated marine and aviation rules and regulations, transistor and digital circuitry. THE GENERAL RADIOTELEPHONE OPERATOR LICENSE - STUDY GUIDE contains vital information. VIDEO SEMINAR KITS ARE NOW AVAILABLE.

WPT PUBLICATIONS
979 Young Street, Suite E
Woodburn, Oregon 97071
Phone (503) 981-5159 Dept. 50

CIRCLE 179 ON FREE INFORMATION CARD

MIDI PROJECTS



BP182—MIDI interfacing enables any so equipped instruments, regardless of the manufacturer, to be easily connected together and used as a system with easy computer control of these music systems. Combine a computer and some MIDI instruments and you can have what is virtually a programmable orchestra. To get your copy send \$6.95 plus \$1.25 for shipping in the U.S. to Electronic Technology Today Inc., P.O. Box 240, Massapequa Park, NY 11762-0240.

LINEAR IC EQUIVALENTS & PIN CONNECTIONS

Linear IC Equivalents and Pin Connections

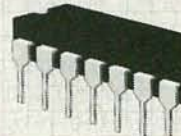

BP141—Shows equivalents & pin connections of a popular user-oriented selection of European, American and Japanese linear IC's 320 pages, 8 x 10 inches. \$12.50 Plus \$2.75 shipping. ELECTRONIC TECHNOLOGY TODAY INC., PO Box 240, Massapequa Park, New York 11762-0240.

AC TO DC CONVERTERS

continued from page 67

BCD-to-analog converter

The input signal to the MC1408 does not have to be pure binary. An array of DAC's can be configured to convert a 2-digit BCD input into a corresponding analog output voltage. Figure 17 shows a circuit that can be used as a BCD-to-analog converter.

Notice that only the lower four bits of each DAC are used to accept the BCD signal. The four most significant bits are grounded. The TTL signal can be provided through discrete sources (such as thumbwheel switches) as well as BCD counters or other binary circuits. The most significant digit DAC drives the op-amp directly. The output from the least significant digit DAC is divided by 10 through a resistor network and added to the signal from the most significant digit to produce the 0- to 10-volt output. The value of the feedback resistor R_F can be adjusted to vary the output range from 0 up to 10 volts.

A BCD input of 00 will yield 0 volts out. As the BCD input increases to 50, the output voltage will climb to 5 volts. An input of 99 will give an output of 10 volts. Since the input range is now only

100 steps (00 to 99), the analog output will travel from 0 to 10 volts over 100 steps instead of the 256 steps that all 8 bits would normally offer. Although a BCD to analog convertor sacrifices

some resolution, it can provide interesting advantages where special inputs are required.

Basic A/D application

A basic A/D converter can be built using a Texas Instruments ADC0808 as shown in Fig. 18. That is also a generic circuit which can be used to interface an analog voltage to a computer port or other digital circuit.

The ADC0808 uses the successive approximation method of A/D conversion. In normal operation, an analog voltage (from 0 to +5 volts) is applied to the IC at V_{IN} . When a conversion is required, a TTL-level start conversion signal is applied to the converter. In that case, a momentary pushbutton is used to provide the pulse. Any other TTL logic pulse may be used to start the conversion as well. A fast square-wave clock source (of about 500 kHz) steps the ADC quickly through its conversion process. When the conversion is complete, the IC will latch the digital result onto the output pins and generate an end of conversion signal.

Since that is a 0 to +5-volt ADC, a 0-volt input will generate a binary 00h at the output. An input of 2.5 volts output 7Fh, and a full 5-volt input output FFh.

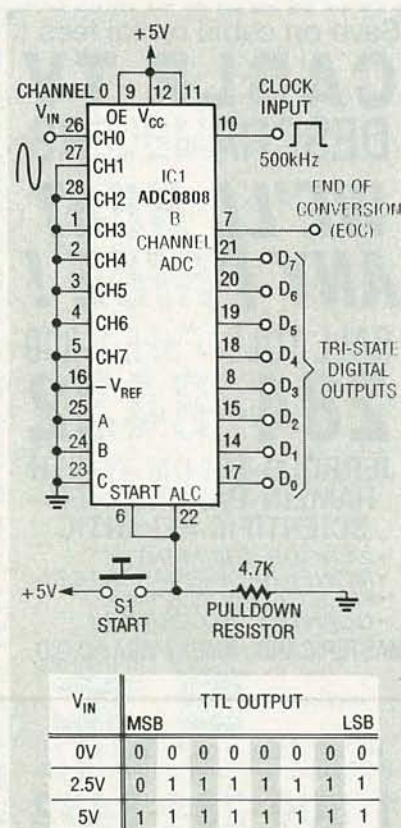

FIG. 18—AN A/D converter circuit using the successive approximation technique.

COMPUTER CONNECTIONS

A new beginning for this column.

JEFF HOLTZMAN

Amiga owners are a small but extremely vocal minority. As expected, my remarks in the April issue generated a fair amount of controversy. In fact, letters continue to arrive. Originally I planned a response for this month but, due to high reader interest, I will wait another month.

New directions

This month is special in other ways, however. It marks a new beginning for this column. For the past four or five years I have focused mostly under the hood, talking about products and technologies in some detail. If you follow the column, you've probably noticed a shift in the past few months to higher-level issues. Beginning this month, I will begin the process of formalizing the shift.

From now on, the column will consist of three major sections: reader interaction, products and technologies, and industry focus. The latter represents the biggest change in format. Each month I will examine what's happening in industry in two broad areas: important new innovations and the movements toward standards and open systems. I will summarize what has happened, based on both published and unpublished reports, and then speculate on what it means. In addition, because at heart I'm really a hands-on kind of person, I'll provide regular product cameos and occasional in-depth reviews. I hope you enjoy the new format; either way, your opinion is welcome.

Standards and integration

It's a commonplace that the U.S. is slipping in several industries: computer systems (both large and small) and semiconductors, to mention a couple. What are the computer and chip companies doing about it, if anything? Large companies are slimming down by eliminating lots of jobs. IBM, for example, recently cut its ranks by

10,000; last year, DEC "downsized" by about 4000. Cutting the fat helps reduce overhead, but doesn't help solve underlying problems, the single largest one of which is lack of responsiveness to real customer needs.

Detroit didn't pay attention when the customer said I want small, efficient, quality-built cars. So Japan stepped in. Nobody in this country listened when the customer said I want small, sexy electronic devices. So Japan stepped in. And Korea. Ad nauseam.

So far the computer industry has been relatively immune to foreign invasion. Nonetheless, customers aren't happy. One of the biggest bones of contention is proprietary standards: incompatible user-interface conventions, networks that won't talk to each other, incompatible data formats among application programs that for all intents and purposes are functionally identical,... ad nauseam.

In some of those areas, the industry has made significant progress. For example, IBM's System Application Architecture (SAA) includes a user-interface component, Common User Access (CUA) that is rapidly becoming the de-facto standard, with support by Windows, OS/2 PM, and OSF/Motif.

In the world of network standards, support for the seven-layer OSI reference model has been increasing steadily. Effective August 1990, the U.S. Government mandated that all future purchases must be compliant with GOSIP, the Government OSI Profile. Because the feds are among the largest market for data-processing equipment, that mandate has already had a calming effect on the industry.

As for cross-platform data incompatibility, that's a problem that is only now beginning to be addressed. Sure, there are translator programs that convert among various database, graphics, and word-pro-

cessor formats. But those are inelegant solutions, akin to asking a diner to prepare his own food. Customers want more.

We've seen limited, platform-specific solutions to this problem before. For example, integrated software (e.g., the Smart series, Microsoft Works), followed by data-exchange format standards (e.g., DDE under Windows and OS/2). Probably the most comprehensive approach to date is being developed by the Object Management Group, a consortium of major computer vendors. Microsoft recently joined the OMG, leaving IBM the only major holdout. OMG is defining a set of application program interfaces (API's) for managing objects in a networked computer environment. If you know anything at all about the term, you know that an *object* consists of both data and code that acts on that data; the latter are called *methods*.

Under the OMG's scheme, application programs will become dumber, because objects will become smarter. Applications will be dumber because they won't have to try to interpret every type of data under the sun. Therefore, they will be more efficient, easier to develop, and more reliable. Data objects will be smarter, hence more useful, because they will know how to do things like print and display themselves. Watch for this type of technology to rapidly change the way we think about "data" and "programs."

A related but perhaps even more ambitious effort is a group called Patriot Partners, composed of 75 assignees from IBM and Metaphor. Patriot Partners is attempting to define and build an object-oriented operating environment that will run on multiple operating systems (Windows, OS/2, OSF/Motif) and will provide a common interface to each. An application built for this environment will run on any underlying OS. Borland has announced support for

I'm not much of an artist, but I love PC-based drawing tools so much that I can't resist getting my hands dirty from time to time. In the PC world, the two premier general-purpose drawing packages are Corel Draw and Micrografx Designer. Designer came out first, and I fell in love with it. Then Corel Systems introduced its product, which is a model of user-interface design. Subsequently, the two programs continually leapfrog each other by increasing features and usability. Version 3.0 of Designer is Micrografx's latest entry; the package has improved tremendously since version 2.0. New features include Bezier curves, much improved text handling, much improved support for symbols (an area in which Corel is still struggling), tracing of bitmap files (PCX, TIFF, etc.), and much improved on-line help and printed documentation. Designer's support for layers and grids is like many CAD programs; Corel also lacks in that area. (Corel leads in 3-D effects, however.) Designer comes with thousands of pieces of clip-art, including many electronics symbols: op-amps, digital logic symbols, diodes, coils, resistors, capacitors, plugs, jacks, speakers, switches, transistors—most of what you need, and of course you can create your own. The program lists for \$695. Micrografx, 1303 Arapaho, Richardson, TX 75081. (800) 733-3729. (214) 234-1769.

CIRCLE 41 ON FREE INFORMATION CARD

The notion of a "dictionary" on a PC used to be ludicrous. Now that virtually all PC's contain hard disks, the idea is much more appealing. Several companies have released PC-based dictionaries; the best is the **American Heritage Electronic Dictionary**. It runs as a RAM-resident program that you can pop up within your word processor (see Fig. 1). It contains the most complete definitions of any electronic PC-based dictionary I've seen, and includes etymologies (word histories). It also contains functions for searching with wildcards, for anagrams, boolean searches, and a thesaurus. For example, can you name any English word that contains all the vowels in order? Think before you read the answer below.

The AHED runs fine under Windows; in 386 Enhanced mode, you can pop the program up in a simulated text-mode screen. The program also comes with a basic word processor called Writer. Without Writer,

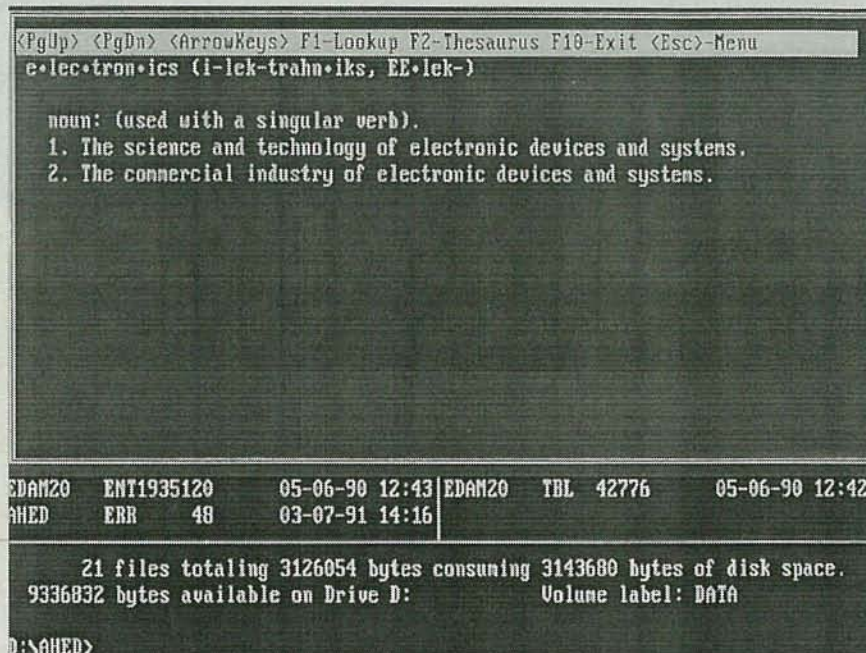

FIG. 1—THE AMERICAN HERITAGE ELECTRONIC DICTIONARY shows pronunciation and word origin, and provides a thesaurus and extensive search capabilities.

the AHED occupies about 3.7 megabytes of disk space. The AHED lists for \$89.95 comes in versions for both PC and Mac, and is available from Houghton Mifflin, One Memorial Drive, Cambridge, MA 02142. (800) 633-4514. (617) 252-3000.

Answers: abstemious, abstemiousness, abstemiously, adventitious, adventitiousness, adventitiously, arsenious, bacteriophagous, facetious, facetiously, have it out, sacrilegious, sacrilegiously, sacrilegiousness, sympathetic nervous system, take into account, take it out on.

CIRCLE 42 ON FREE INFORMATION CARD

There are lots of menu programs for Windows 3.0 that provide a convenient way to organize and launch your applications. The simplest and most elegant I've seen is a little shareware program called **Launch**. With Launch installed, you click on the desktop background, and hold the left button down. A menu pops up that lists your favorite applications. Highlight your choice, release the mouse button, and you're off. The program includes several convenience items that you can add to the menu as well, including functions to arrange icons on the desktop and to exit Windows. The program reads the menu from an ASCII text file, so it's easy to create and update. As I write, the program is in version 1.5;

2.0 is due by the time you read this. If you feel overburdened by the fancy menu programs, you'll love Launch. I'll post a copy on the RE-BBS (516-293-2283, 1200/2400, 8N1).

I'll also post a copy of **ASQ**, a program for analyzing PC memory and hardware configuration. Qualitas (the 386Max people) wrote ASQ and are distributing it at no cost. It's got some advertising hype, but includes a fair amount of system and tutorial information. Other companies charge \$30 to \$100 for this type of program.

At a recent trade show, I accidentally ran into a representative of the Canadian company that wrote and distributes the **Electronics Workbench**, a CAD-like program that allows you to simulate analog and digital circuits on a PC compatible. As reported here in the December 1990 column, the program is great for beginning and intermediate students, but at \$650, much too expensive for individual purchase. My writeup generated a lot of reader interest; consequently, the company got together with a large U.S. publishing firm, and expects to release a "personal" version by next fall. Cost should be about \$30, and will include some sort of workbook and a functional program. Stay tuned for details, or contact the company directly (and tell 'em we sent you). Interactive Image Technologies, 49 Bathurst St., Suite 401, Toronto, Ontario, Canada, M5V 2P2. (416) 361-0333. **R-E**

R-E Computer Admart

Rates: Ads are 2 1/4" x 2 1/8". One insertion \$995 each. Six insertions \$950 each. Twelve insertions \$925 each. Closing date same as regular rate card. Send order with remittance to Computer Admart, Radio-Electronics Magazine, 500-B Bi-County Blvd., Farmingdale, NY 11735. Direct telephone inquiries to Arline Fishman, area code-1-516-293-3000. FAX 1-516-293-3115. Only 100% Computer ads are accepted for this Admart.

HOW TO EXPAND, MODERNIZE AND REPAIR PCs AND COMPATIBLES



BP271—Includes PC overview, memory upgrades, adding a hard disc, adding floppy drives, display adapters and monitors, installing a co-processor, preventive maintenance, repairs, do it yourself PCs and more. To order your copy send \$7.75 plus \$2.00 for shipping in the U.S. to **Electronic Technology Today Inc., P.O. Box 240, Massapequa Park, NY 11762-0240.**

SECRETS OF THE COMMODORE 64

Secrets of the COMMODORE 64



BP135—A beginners guide to the Commodore 64 presents masses of useful data and programming tips, as well as describing how to get the best from the powerful sound and graphics facilities. We look at how the memory is organized, random numbers and ways of generating them, graphics-color and simple animation, and even a chapter on machine code. Get your copy today. Send \$5.00 plus \$1.25 for shipping in the U.S. to **Electronic Technology Today Inc., P.O. Box 240, Massapequa Park, NY 11762-0240.**

ICs PROMPT DELIVERY!!!

SAME DAY SHIPPING (USUALLY)
QUANTITY ONE PRICES SHOWN for APRIL 28, 1991

Memory for almost ALL computers

DYNAMIC RAM

4M Board for hp LJ's w/2MB	\$148.00
SIMM 4Mx9 80 ns	190.00
SIMM 1Mx9 60 ns	63.00
SIMM 1Mx9 80 ns	51.00
4 Mbit 4Mx1 80 ns	28.00
4 Mbit 1Mx4 80 ns	34.00
1 Mbit 1Mx1 80 ns	5.50
41256 256Kx1 100 ns	1.95
41256 256Kx1 120 ns	1.75
44256 256Kx4 100 ns	5.75
4464 64Kx4 100 ns	1.95

EPROM

27C4001 512Kx8 150 ns	\$55.00
D28F010 128Kx8 150 ns	24.00
27C1000 128Kx8 150 ns	16.50
27C512 64Kx8 120 ns	7.50
27128 16Kx8 250 ns	3.40

STATIC RAM

1 Mbit 128Kx8 100 ns	\$15.00
62256LP 32Kx8 100 ns	6.50

OPEN 6 1/2 DAYS, 7:30 AM-10 PM SHIP VIA FED-EX ON SAT.

SAT DEL ON MasterCard VISA or UPS CASH COD
RED-EX ORDERS RECEIVED BY: MICROPROCESSORS UNLIMITED, INC.
24 000 S. Peoria Ave.
Tl: 52 5625 4 b BEGGS, OK 74421 (918) 267-4961
Fr: P1 51700 1 b No minimum order. Please note: prices subject to change!
COD AVAILABLE Shipping, insurance extra, up to \$1 for packing materials.

CIRCLE 61 ON FREE INFORMATION CARD

this environment; as the premier supplier of object-oriented programming tools, this is exciting news.

A related development is Unicode, a consortium of leading computer vendors (IBM, Apple, Microsoft, Sun, Next, Novell, and others) that has begun the process of defining the successor to the ASCII character set. ASCII is a seven-bit code, limited to 128 characters. By contrast, Unicode is a 16-bit code, allowing 64K characters, enough to represent all western languages unambiguously, and a good start on eastern languages as well.

News bits

Recession? What recession? After hitting an all-time low in November of 1990, semiconductor sales are on the rise again. The first two months of 1991 set an all-time record, and the Semiconductor Industry Association is optimistic that the industry could grow by about 10% this year. **MacClones?** Apple's

continually shrinking market share has finally forced Sculley and crew to understand that they're in business to sell computers, not religion. The company recently acknowledged interest in licensing the Mac operating system to vendors of other hardware platforms, most likely including some flavor of Intel chips. With the rapidly increasing popularity of the 386/486, technical problems should be few, as the advanced Intel processors overcome the limitations of earlier processors that used to make the Motorola family attractive. **PolyGlot PostScript.** Adobe Systems is expected to announce a PostScript-based utility that allows transparent data sharing across multiple platforms. **OS Soup.** IBM will try to ease skepticism about OS/2 with a marketing blitz designed to promote understanding of the operating system, applications for it, DOS and Windows compatibility, and futures. Watch for OS/2 2.0 to sweep the industry just like Windows 3.0 has.

486 blues

Just when 386-based systems start to become affordable, the 486 moves in as the new high-end option. However, the 486 may penetrate the market much quicker than did the 386. Intel is poised to release several updated 486's, a 50-MHz unit, and a "crippled" or de-featured unit (variously called the P23 and the 486SX) that comes without the math coprocessor, and that runs slower (20 MHz) than a full 486. Remember that even running at the same clock speed, a 486 is about twice as fast as a 386. Several vendors have already announced P23 systems priced under \$3000.

The P23 isn't stopping American Micro Devices, which is shipping 40-MHz versions of its 386 clone. Also, Chips & Technologies and Cyrix have introduced system logic and math coprocessors, respectively, that support the new device. Intel's not scared, however; the company has shown a 486 running at 100 MHz. **R-E**

COLOR BAR GENERATOR

continued from page 45

chroma on the white bar (the first bar after horizontal sync) with R10 and R9.

Adjustment with Monitor

If you have a monitor, hook up the video output of the video generator to the monitor's video in-

put and do all the adjustments looking at the white color bar on the left side of the screen. If the red, green, and blue video levels are set up properly the white bar should be full brightness and white. If it is not, adjust R8 for the overall brightness and then adjust R10 and R9 for a pure white bar.

We hope you've learned some-

thing about color video from this project. Everything is neatly broken into fairly simple blocks so you can be assured of success. If you have an IBM Clone computer with a CGA board (or other video card with NTSC-compatible sync) you can use just the encoder section to generate NTSC-compatible sync and RGB video outputs.

R-E

JULY 1991

The two most comprehensive electronics

Take any 3 books for only \$9⁹⁵

as your introduction to the *new* ELECTRONICS ENGINEERS' BOOK CLUB

Values to
\$116.40

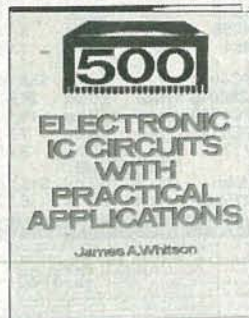

2920 **\$29.95**
A wealth of electronic circuits and information on building working devices. 336 pp.

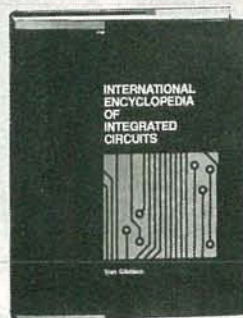

3100 **\$75.00**
This quick-reference provides pin-out diagrams, internal block diagrams and schematics, characteristic curves, descriptions and applications—for foreign and domestic ICs! 1088 pp. *Counts as 3*



9255 **\$89.50**
"Outstanding, extensive reference to current technology of electronics. Covers everything from principles to applications."
—Computer Book Review
2528 pp., 1800 illus. *Counts as 3*

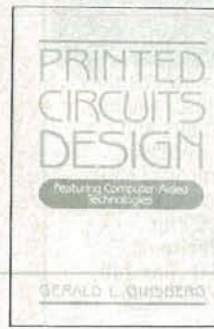

10016 **\$39.95**
Design tighter, more complex circuits, on time and on budget with this book, one of the first to provide a thorough coverage of all aspects of PCB design, including CAD. 320 pp.

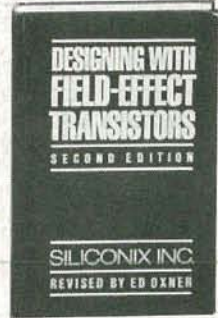

057537-1 **\$39.95**
This on-the-job guide provides page after page of practical data, tables, examples, and design and specification strategies to help you capitalize on recent breakthroughs in MOSFET design. 320 pp., illus. *Counts as 2*

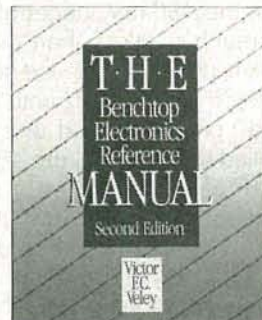

3414 **\$39.95**
Completely updated with new sections on mathematics and digital electronics. The most complete reference available on all areas of electronics. 816 pp., 389 illus. *Counts as 2*

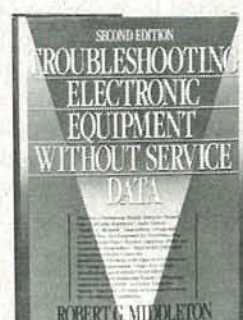

9290 **\$36.00**
Provides many never-before-published troubleshooting techniques and case histories. 315 pp. *Counts as 2*

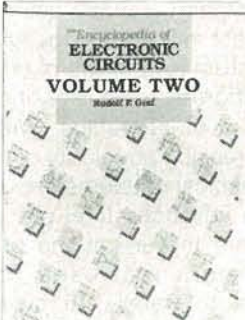

3138 **\$60.00**
More than 700 state-of-the-art electronic circuit designs for on-the-job use. 738 pp. *Counts as 2*

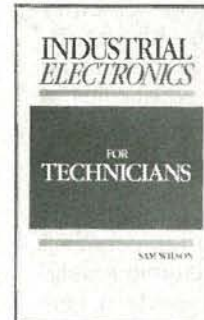

3321P **\$16.95**
A valuable workbench companion covering industrial hardware theory and application. 334 pp.



2672 **\$49.50**
Linear integrated circuits—specifications, prices & data 614 pp.

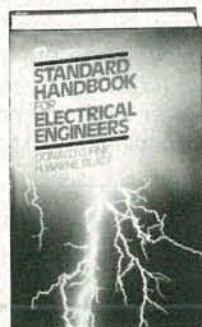

020975-8 **\$99.50**
The essential reference for all electrical engineers. Covers basic circuits and measurements to advanced topics. 2416 pp., 1388 illus., 430 tables. *Counts as 3*

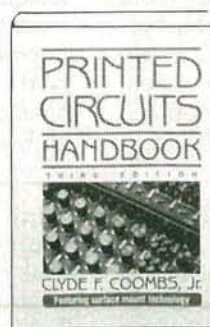

012609-7 **\$64.95**
All the information you need to design, manufacture, test, and repair printed wiring boards and assemblies. 960 pp., 556 illus. *Counts as 2*

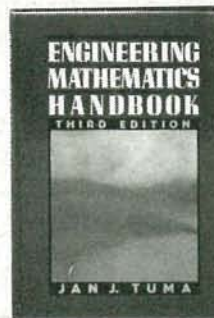

065443-3 **\$57.50**
This best-selling handbook gives you the essential mathematical tools—formulas, definitions, theorems, tables, and models for computer programming. 512 pp., illus. *Counts as 2*



028735-X **\$79.50**
Puts more than 1,100 specific calculation procedures at your fingertips. Every procedure gives the exact, numbered steps to follow for a quick, accurate solution. 1468 pp., 793 illus., 499 tables. *Counts as 3*



8225P **\$19.95**
Tested programs for most mathematical computing needs. 233 pp.

engineering clubs have joined forces...



053570-1 \$64.95
Everything you need to design or work with communications receivers such as: shortwave, broadcast, radar, military, marine, and more. 608 pp., 402 illus. *Counts as 2*

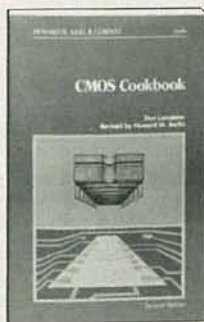

9244P \$18.95
This revised and updated edition is both a comprehensive, industry-wide reference, and a valuable collection of project ideas. 512 pp.



2962P \$17.95
Complete schematic diagrams, parts lists, and photos for building a variety of projects. 240 pp.



3199 \$52.00
Layout and design guidelines for efficient processing, inspection and repair. 180 pp. *Counts as 2*



10037 \$44.95
The most up-to-date guide on CMOS and BiCMOS. Gain practical engineering solutions to designing and building reliable, cost-effective digital systems. 320 pp. *Counts as 2*

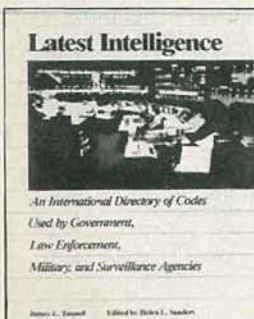

3531 \$26.95
A first-time compilation of 35,000 terms, phrases, abbreviations, and acronyms used in the international intelligence, law enforcement, military, and aeronautics communities. 320 pp.



3313 \$22.95
Prepare concise papers and enhance your professional standing with this guide. Get instructions on writing reports, proposals, books, and oral presentations. 144 pp., 37 illus.



9305 \$59.50
The solution-oriented handbook for practicing engineers at all levels. Contains hundreds of informative illustrations and diagrams demonstrating key principles. 600 pp. *Counts as 2*

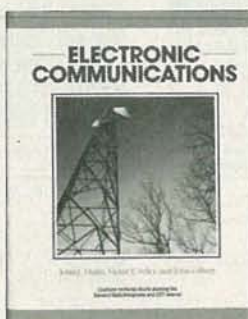

3365 \$34.95
Use this broad study to prepare you for your FCC General Radiotelephone Operator License or CET exam, then keep it on your desk as a handy working reference. 704 pp.



3140 \$49.95
Includes details on PLD technology: architectural characteristics, tech. tradeoffs, logic synthesis, software tools, development systems, and hardware. 480 pp. *Counts as 2*

How the Club Works:

The Electronics Engineers and Designers Book Club and the Electronics and Control Engineers' Book Club have joined forces to bring you *all* the best titles from the most prominent electronics publishers.

YOUR BENEFITS: You get 3 books for \$9.95 plus shipping and handling when you join. You keep on saving with discounts of up to 50% off as a member.

YOUR PROFESSIONAL BOOKSTORE BY MAIL: Every 3-4 weeks, you will receive the Electronics Engineers Book Club News describing the Main Selection and Alternates, as well as bonus offers and special sales, with scores of titles to choose from.

CLUB CONVENIENCE & EASY RISK-FREE TERMS: If you want the Main Selection, do nothing and it will be sent to you automatically. If you prefer another selection, or no selection at all, simply indicate your choice on the reply form provided. You will have at least 10 days to decide. As a member, you agree to purchase at least 3 books within the next 2 years and may resign at any time thereafter. If not satisfied with your books, return them within 10 days without obligation!

BONUS BOOKS: Starting immediately, you will be eligible for our *Bonus Book Plan*, with savings of up to 80% off publishers' prices.

EXCEPTIONAL QUALITY: All books are top-quality editions from ALL the publishers in the field especially selected by our Editorial Board to ensure the information provided is reliable and specific enough to meet your needs.

All books are hardcover unless number is followed by a "P" for paperback. (Publishers' Prices Shown) ©1991 EEBC, Blue Ridge Summit, PA 17294-0860

...to bring you the largest selection of titles available anywhere else—at savings of up to 50% off publishers' prices!

ELECTRONICS ENGINEERS' BOOK CLUB

Blue Ridge Summit, PA 17294-0860

YES! Please accept my membership in the ELECTRONICS ENGINEERS BOOK CLUB and send my 3 volumes listed below billing me \$9.95. If not satisfied, I may return the books within 10 days and have my membership cancelled. I agree to purchase 3 or more books at regular Club Prices during the next 2 years, and may resign any time thereafter. A shipping/handling charge and sales tax will be added to all orders.

--	--	--

Name _____

Address _____

City _____

State _____ Zip _____ Phone _____

Valid for new members only. Foreign applicants will receive special ordering instructions. Canada must remit in U.S. currency. This order subject to acceptance by the Electronics Engineers Book Club. DRE791

MARKET CENTER

FOR SALE

TUBES: "oldest," "latest." Parts, and schematics. SASE for lists. **STEINMETZ**, 7519 Maplewood Ave., RE, Hammond, IN 46324.

ENGINEERING software, PC/MSDOS. Circuit design and drawing, PCB layout, Logic simulation, FFT analysis, Mathematics, Circuit analysis. Call or write for free catalog. 1 (800) 728-3805, **BSOFT SOFTWARE, INC.**, 444 Colton Rd., Columbus, OH 43207.

RESTRICTED technical information: Electronic surveillance, schematics, locksmithing, covert sciences, hacking, etc. **Huge selection. Free brochures.** **MENTOR-Z**, Drawer 1549, Asbury Park, NJ 07712.



Quality Microwave TV Antennas

WIRELESS CABLE - IFTS - MMDS - Amateur TV
Ultra High Gain 50db(+) • Tuneable 1.9 to 2.7 Ghz.

- 36-Channel System Complete \$149.95
- 12-Channel System Complete \$114.95
- Call or write (SASE) for "FREE" Catalog

PHILLIPS-TECH ELECTRONICS
P.O. Box 8533 • Scottsdale, AZ 85252
(602) 947-7700 (\$3.00 Credit all phone orders)
MasterCard • Visa • COD's • Quantity Pricing

LIFETIME WARRANTY

WELL established electronics repair business with great growth potential, large inventory, asking \$125,000.00. Write to **M. TROUTMAN**, Box 760, Brewer, ME 04412-0760.

CB RADIO OWNERS!

We specialize in a wide variety of technical information, parts and services for CB radios. 10-Meter and FM conversion kits, repair books, plans, high-performance accessories. Thousands of satisfied customers since 1976! Catalog \$2.

CBC INTERNATIONAL
P.O. BOX 31500RE, PHOENIX, AZ 85046

CABLE TV converters: Jerrold, Oak, Scientific Atlantic, Zenith & many others. "New MTS" stereo add-on: mute & volume. Ideal for 400 and 450 owners! 1 (800) 826-7623, Amex, Visa, M/C accepted. **B & B INC.**, 4030 Beau-D-Rue Drive, Eagan, MN 55122.

TUBES, new, up to 90% off, SASE, **KIRBY**, 298 West Carmel Drive, Carmel, IN 46032.

CABLE TV converters and descramblers. We sell only the best. Low prices. **SB-3 \$79.00**. We ship C.O.D. Free catalog. **ACE PRODUCTS**, PO Box 582, Dept. E, Saco, ME 04072. 1 (800) 234-0726.

CABLE descramblers (Jerrold) from \$40.00. Tocom VIP test chip. Fully activates unit. Also Zenith test board. Fully activates Z-Tacs. \$50.00. Call (213) 867-0081.

T.V. notch filters, phone recording equipment, brochure \$1.00. **MICRO THINC.**, Box 63/6025, Margate, FL 33063. (305) 752-9202.

TOCOM VIP converters w/remotes from \$299.00. **TOCOM PREMIUM SUPER CHIPS** from \$49.00 turn on everything, guaranteed. Phone (219) 935-4128 Evenings 6-12PM EST.

TEST equipment pre-owned now at affordable prices. Signal generators from \$50.00, oscilloscopes from \$50.00, other equipment, including manuals available. Send \$2.00 U.S. for catalog, refunded on 1st order. **J.B. ELECTRONICS**, 3446 Dempster, Skokie, IL 60076. (708) 982-1973.

DISCOUNT computer books: Thousands of titles available. Including recent releases. Please call or write for your **free** catalog. **BOOKWARE**, 344 Wattertown Road, Thomaston, CT 06787. 1 (800) 288-5662. (203) 283-6973.

FREE CATALOG

FAMOUS "FIRESTIK" BRAND CB ANTENNAS AND ACCESSORIES. QUALITY PRODUCTS FOR THE SERIOUS CB'er. SINCE 1962
FIRESTIK ANTENNA COMPANY
2614 EAST ADAMS
PHOENIX, ARIZONA 85034

CONVERTERS all major brands info + orders 1 (800) 782-0552 **FREEMAN INC.** (s.m.p.), PO 5036, Burnsville, MN 55337. No MN sales.

CBTV converters: JSX — DIC, Oak M35B \$19.00. Minimum 10 lots. Other brand in stock. (405) 685-3174.

UNICORN - YOUR I.C. SOURCE & MUCH, MUCH MORE!

<p>Laser Diode (visible-red)</p> <ul style="list-style-type: none"> • Output: 3 mW (max.) • Current: 85-100 mA • Op. Volt.: 2.3-3.0V • Wavelength: 670NM • Lens Required • Data Sheet & Application notes inc. 	<p>Laser Diode (visible red)</p> <ul style="list-style-type: none"> • Output: 5 mW (max.) • Current: 65-100 mA • Op. Volt.: 1.75-2.2V • Wavelength: 780NM • Lens Required • Data Sheet & Application notes inc. 	<p>Laser Diode (visible red)</p> <ul style="list-style-type: none"> • Output: 4 mW (max.) • Current: 20 mA • Op. Volt.: 2.3-3.0V • Wavelength: 670NM • Lens Required • Data Sheet & Application notes inc. 	<p>Laser Diode (visible red)</p> <ul style="list-style-type: none"> • Output: 5 mW (max.) • Current: 60 mA • Op. Volt.: 2.3-3.0V • Wavelength: 670NM • Lens Required • Data Sheet & Application notes inc. 	<p>Laser Diode (Infra-red)</p> <ul style="list-style-type: none"> • Output: 3 mW (max.) • Current: 85-100 mA • Op. Volt.: 2.3-3.0V • Wavelength: 820NM • Lens Required • Data Sheet inc.
---	--	---	---	---

STOCK # LS9200	PRICE \$49.99	STOCK # LS022	PRICE \$19.99	STOCK # SB3200	PRICE \$89.99	STOCK # LS9211	PRICE \$69.99	STOCK # SB1053	PRICE \$9.99
-----------------------	----------------------	----------------------	----------------------	-----------------------	----------------------	-----------------------	----------------------	-----------------------	---------------------

<p>Collimator Pen (Infra-red)</p> <ul style="list-style-type: none"> • Output: 2.5 mW (max.) • Current: 90-150 mA • Op. Volt.: 2.2-2.5V • Wavelength: 820NM • Data Sheet inc. 	<p>Laser Pointer</p> <ul style="list-style-type: none"> • Output: 3.5 mW • Wavelength: 670NM • Power Supply: 2xAAA Batteries (included) • Beam: Approx. 3" @ 100 yards Quantity Discounts Available 	<p>Power Supply</p> <ul style="list-style-type: none"> • Input: 115/230V • Output: +5v @ 3.75A +12v @ 1.5A -12v @ .4A • Size: 7" L x 5 1/2" W x 2 1/2" H
---	---	--

STOCK # LB1052	PRICE \$39.99	STOCK # LSPPOINT	PRICE \$199.99	STOCK # PS1003	PRICE \$19.99
-----------------------	----------------------	-------------------------	-----------------------	-----------------------	----------------------

<p>Disc Drive & Computer Cleaning Kit</p> <p>Not just a drive cleaner—but a complete computer cleaning kit. Includes swabs, head cleaning fluid, anti-static cleaner, screen wipes and cleaning diskette.</p>	<p>Disc Drive Head-Cleaning Kit</p> <p>Includes cleaning fluid and head-cleaning fluid</p>	<p>Anti-Static Screen Wipes</p> <p>For static-sensitive applications. Dispenser packs, individually wrapped.</p>
--	---	---

STOCK # SB1099	3 1/2" Kit	PRICE \$6.99	STOCK # SB1105	3 1/2" Drive Kit	PRICE \$1.99	STOCK # SB1104	PRICE
STOCK # SB1100	5 1/4" Kit	PRICE \$6.99	STOCK # SB1106	5 1/4" Drive Kit	PRICE \$1.99	STOCK # SB1106	PRICE



10010 Canoga Ave., Unit B-8 • Chatsworth, CA 91311
OUTSIDE CALIFORNIA: (800) 824-3432 (Orders Only)
IN CALIFORNIA: (818) 341-8833
ORDER BY FAX: (818) 998-7975
 Minimum Order \$15.00 • 24-hour ordering available

EPROMS

STOCK #	1-24	25-99	100+	STOCK #	1-24	25-99	100+
1702	4.59	4.36	3.92	2764A	3.49	3.32	2.99
2708	6.49	6.17	5.55	TMS2564	5.79	5.50	4.95
2716	3.29	3.13	2.82	27C64	3.29	3.13	3.28
2716-1	3.79	3.60	3.24	27128-20	4.99	4.74	4.27
TMS2716	5.79	5.50	4.95	27128	4.79	4.55	4.09
27C16	3.99	3.79	3.41	27128A	4.79	4.55	4.09
2732	4.19	3.98	3.58	27C128	4.79	4.55	4.09
2732A-2	3.79	3.60	3.24	27256-20	5.29	5.03	4.53
2732A	3.69	3.51	3.16	27256	4.79	4.55	4.09
2732A-4	3.19	3.03	2.73	27C256	4.29	4.08	3.67
TMS2532	5.79	5.50	4.95	27512-20	6.49	6.17	5.55
TMS2532P	1.99	1.89	1.70	27512	5.99	5.69	5.12
27C32	3.79	3.60	3.24	27C512	5.99	5.69	5.12
2764-20	4.29	4.08	3.67	27C1024	12.99	12.34	11.11
2764	3.99	3.79	3.41	68764	13.99	13.29	11.96
2764A-20	3.99	3.79	3.41	68766	12.99	12.34	11.11

DYNAMIC RAMS

STOCK #	1-24	25-99	100+	STOCK #	1-24	25-99	100+
MK4027	.59	.56	.50	4464-100	2.99	2.84	2.56
4116-120	1.39	1.32	1.19	4464-120	2.79	2.65	2.39
4116-150	.99	.94	.85	4464-150	2.29	2.13	1.96
4116-200	.89	.85	.77	41256-60	2.99	2.84	2.56
4116-250	.59	.56	.50	41256-80	2.79	2.65	2.39
4164-100	1.89	1.80	1.63	41256-100	1.99	1.89	1.70
4164-120	1.69	1.61	1.55	41256-120	1.89	1.80	1.63
4164-150	1.59	1.51	1.36	41256-150	1.79	1.70	1.53
4164-200	1.39	1.32	1.19	511000-70	6.49	6.17	5.55
4416-120	1.99	1.89	1.70	511000-80	5.99	5.69	5.12
4416-150	1.79	1.70	1.53	511000-100	5.49	5.22	4.70

WIRELESS CABLE RECEIVERS 1.9 TO 2.7 GHz



30 CH PARABOLIC DISH SYSTEM \$173.90
 30 CH ROD ANTENNA SYSTEM \$193.90
 30 CH CRYSTAL CONTROLLED SYSTEM \$294.95

SUN MICROWAVE INT'L. INC. SEND \$1.00 FOR
 P.O. BOX #34522 CATALOG ON THESE
 PHOENIX, AZ. 85067 AND OTHER FINE
 (602) 230-1245 VIDEO PRODUCTS
 QUANTITY DISCOUNTS
 ORDERS ONLY 1-800-484-4190 CODE 3793

BOOKS! Optics, lasers, Tesla coils, influence machines, holography, experimental electronics, science & more! Free catalog! Box 596-R, Logan, Utah 84321. (801) 753-2321.

HIGH-VOLTAGE plans. Create fork lightning 50,000V — 1,200,000V ... Catalog \$1.00. **SCIENTIFIC**, Box 1054RF, Duvall, WA 98019.

CABLE descramblers, 4040 with internal descrambler, replace all SB systems — 400 DIC ECT \$89.00 or 10 @ \$79.00 complete with remote, Oak RTC-56 with remote \$135.00, M-35-B 10 @ \$34.00, Tocom 5503-A with remote \$199.00, SA3-B or fast Tri-Bi \$79.00, Z-Tac \$225.00, **MOUNT HOOD ELECTRONICS** (503) 253-0459.

CIRCUIT Center — Complete circuit fabrication from single piece single sided to production multi-layer. Also — Laminate \$5.50/sq. ft., etch \$3.50/qt. Thru hole plating available too. **CIRCUIT CENTER**, Dept. 001, PO Box 128, Addison, IL 60101. (708) 543-0671.

PHOTOFACT folders under #1400 \$5.00. Others \$7.00. Postpaid. **LOEB**, 414 Chestnut Lane, East Meadow, NY 11554.

ELECTRONIC supermarket great buys! Surplus prices! Railroaders, builders, engineers, experimenters, **LSASE, FERTIK'S**, 5400 Ella, Phila., PA 19120.

CABLE TV "BOXES"

Converters • Descramblers
 Remote Controls • Accessories

FREE CATALOG!

1-800-437-4720

- GUARANTEED BEST PRICES!
- 1 YEAR WARRANTY • C.O.D.'s
- IMMEDIATE SHIPPING!

DECA ELECTRONICS
 4835 N. O'Connor Rd.
 Dept. 134-535
 Irving, Texas 75062
SORRY - NO TEXAS SALES



VIDEOSENDER, wireless. Send cable signal to anywhere in the house, even backyard. Link VCR/TV, camera/TV, VCR/VCR. \$29.95 + \$4.00 S&H. **NET ELECTRIC**, Dept. R, 4901 Cumberland, MTL, Quebec, H4V 2N5. (514) 481-2311, (514) 481-8119, M/C, VISA. 1 year warranty.

DESCRAMBLERS, Oak RTC-56 \$135.00, Tocom 5503 \$199.00, Oak M35B \$39.00, Sylvania 4040 combo \$79.00, SA-3-B — FTB \$79.00 10 @ \$69.00, C.O.D. OK. S.A.C., 1 (800) 622-3799.

TECHNICIANS. The ultimate test lead, jumper cables with switch \$14.95 each. **MHA**, PO Box 152797, San Diego, CA 92195.

UNDERSTANDING Telecommunications by Ronald R. Thomas (W8QYR). A single-source reference to the entire field of telecommunications. Available from **TAB BOOKS**, Blue Ridge Summit, PA 17294-0850.

CALL DOCTOR DESCRAMBLER

...for symptoms relating to scrambled cable T.V. signals. We have • **JERROLD** • **TOCOM** • **ZENITH** • **HAMLIN** • **OAK** • **SCIENTIFIC ATLANTA**. Six month warranty! We ship C.O.D. Lowest retail/wholesale prices. **FREE CATALOG: VISA, M.C., AMEX.**

Global Cable Network
 1032 Irving St. Suite
 109 S.F., CA 94122
NO CALIFORNIA SALES!!!
OPEN SATURDAYS



VISA
 M.C.
 AMEX

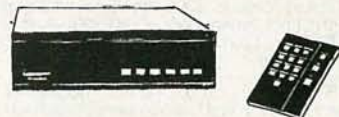

1-800-235-6730

MARK V ELECTRONICS, INC.

Competitive Pricing * Fast Shipping Since 1985

ORDER IN CALIFORNIA 800-521-MARK
 ORDER OUTSIDE CA 800-423-FIVE
 FREE CATALOG & INFORMATION (213) 888-8988
 FAX (213) 888-6868

▲ indicates the level of difficulty in the assembling of our Products. ▲ Beginner ▲▲ Intermediate ▲▲▲ Advanced ★ Fully Assembled

Amplifier + Metal Cabinet + Transformer	TA-3600 LG-1925 #007	TA-477 LG-1925 #003	TA-802 LG-1924 #001	TA-1000A LG-1924 #001	TA-1500 LG-1925 #001
Kit Set	\$155.61	\$125.21	\$100.45	\$113.52	\$130.00
Assmb. Set	\$179.36	\$141.36	\$113.54	\$133.36	\$150.00

• Due to this special offer & low price, we can only exchange or repair any of these units (TA-3600, TA-477, TA-802 & TA-1000A) within 15 days of your receipt.
 • The above prices are for the complete sets. For separate unit price, please see below.

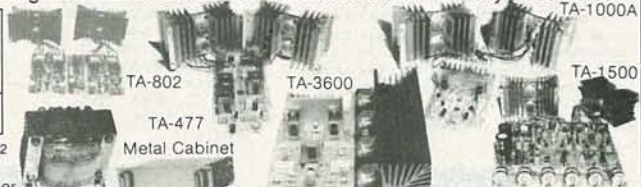

AMPLIFIERS		KIT ASSEMB.	
MODEL	DESCRIPTION		
TA-28MK2	Digital Voice Memo ▲▲	\$ 30.00	
TA-50A / B	Multi-Purpose Melody Generator ▲	12.84	17.20
TA-50C	Multi-Purpose Melody (Happy Birthday, Wedding March, etc.) Generator ▲	13.65	18.71
TA-120MK2	35W Class 'A' Main Power Mono Amp ▲▲	31.50	42.80
TA-300	30W Multi-Purpose Single Channel Amp. ▲	20.00	29.00
SM-302	60W + 60W Stereo Power Amplifier (with Mic. input)▲▲	67.00	78.00
TA-323A	30W X 2 Stereo Pre-main Amp. ▲	31.50	42.80
TA-377A	State of the Art Fully Complementary Symmetrical FET Pre-Amp. ▲▲▲	59.95	75.00
TA-400	40W Solid State Mono Amp. ▲	28.00	34.93
TA-477	120W Mosfet Power Mono Amp. ▲▲	68.00	85.00
TA-800MK2	120W + 120W Low Tim Pre-Main Stereo Power Amp. ▲▲	63.92	
TA-802	80W + 80W Pure DC Stereo Main Power Amp. ▲▲	45.94	59.72
TA-1000A	100W Dynamic Class 'A' Main Power Mono Amp. ▲▲	59.69	80.58
TA-1500	100W X 2 Class 'A' DC Stereo Pre-Main Amp. ▲▲▲	73.70	95.81
TA-2200	DC Fet Super Class 'A' DC Pre-Amp. ▲▲▲	47.70	58.24
TA-2400A	Electronic Echo & Reverberation Amp. ★		96.00
TA-2500	HD Pre-Amp w/10 band graphic equalizer ★		68.80
TA-2800	BI-FET IC Pre-Amp w/3 way tone control ▲	48.90	63.57
TA-3000	Stereo Simulator (For Mono TV or Any Mono Source) ▲▲	27.00	38.50
TA-3600	300W HD HI-FI Power Mono Amp. ▲▲	85.00	110.00
SM-222	7 Band HI-FI Graphic Equalizer ▲▲▲	26.80	38.80
SM-328	4 Channel Professional Color Light Controller★		145.00
SM-333	Audio/Video Surround Sound Processor ▲▲▲▲	65.00	75.00
SM-666	Dynamic Noise Reduction ▲	26.00	34.00
SM-888	Universal Audio/Video KARAOKE Mixer, Pre-Amp. ★		225.00

MISCELLANEOUS		KIT ASSEMB.	
MODEL	DESCRIPTION		
TY-23B	3 Channel Color Light Controller ★	\$	\$ 65.00
TY-25	Stereo Loudspeaker Protector ▲	14.85	20.85
TY-35	FM Wireless Microphone ▲	11.25	
TY-36	AC/DC Quartz Digital Clock ▲	19.00	26.20
TY-38	Sound / Touch Control Switch ▲	12.00	
TY-41MKV	Infrared Remote Control Unit (w/Case) ▲▲▲	22.00	
TY-42	Bar / Dot Level Meter ▲▲	24.15	33.81
TY-43	3 1/2" Digital Panel Meter ▲	29.00	38.00
TY-45	20 Steps Bar / Dot Audio Level Display ▲▲	38.45	46.14
TY-47	Superior Electronic Roulette ▲▲	19.46	27.24
10,000u/f	80 V Capacitor (Suggested for TA-3600, TA-477, TA-1000A & TA-802)		23.00

REGULATORS		KIT ASSEMB.	
TR-355A	0-15V 5A Regulated DC Power Supply (no case & x former) ▲	\$15.65	\$ 21.76
TR-355B	0-30V 3A Regulated DC Power Supply (no case & x former) ▲	15.85	21.76
TR-503	0-50V 3A Regulated DC Power Supply (no case & x former) ▲▲	16.75	23.65

METAL CABINETS WITH ALUMINUM PANEL			
MODEL	H" x W" x D"	MATCHING	PRICE
LG-1273	3" 12" 7"	TA-2800, TA-377A, TA-2200	\$ 22.85
LG-1684	4" 16" 8"	TA-323A, TA-377A, TA-2200	27.50
LG-1924	4" 19" 11 1/2"	TA-802, TA-1500, TA120MK2, TA-800 MK2, TA-1000A	32.80
LG-1925	5" 19" 11 1/2"	TA-477, TA-800, MK2, TA-1500, TA-1000A, TA-3600	35.80
LG-1983	2 1/4" 19" 8"	TA-377A, TA-2800, TA-2200, TA-120MK2	29.25

POWER TRANSFORMERS			
MODEL	DESCRIPTION	MATCHING	PRICE
001	28V x 2.6A to 30V x 2.6A	TA-800 MK2, TA-802, TA-820A, TA-1000A, TA-1500	\$ 27.00
002	36V x 2.3A	TR-503, TA-323A, TA-400, TA-300, TA-377A	22.00
003	40V x 2.6A	TA-477	28.00
004	24V x 2.6A	TA-120 MK 2	22.00
005	26V x 2.3A	TR-355B	16.00
006	18V x 2.5A	TR-355A	15.50
007	53V x 2.8A	TA-3600	43.00

We accept major Credit Cards, Money Orders, Checks and C.O.D. Orders. C.O.D. fee is \$5.00. Minimum order is \$20.00. • We ship by UPS ground inside US (min. \$3.00) and ship by US mail Business & Showroom hours: (Pacific Time) outside US. Please call our sales department for orders over 2 lbs. or foreign orders. • All assembled units have a 30 days warranty. • Quality or Volume discount available upon request. • Residents of CA please add sales tax 6.75%. • All merchandise checks are subject to prior sale. Prices are subject to change without prior notice. We are not responsible for typographical errors.

MARK V ELECTRONICS, INC. - 8019 E. Slauson Ave, Montebello, CA 90640

JULY 1991



ANNOUNCING:
AN END
TO
HIGH MONTHLY
CABLE FEES!

All Jerrold, Oak, Hamlin, Zenith, Scientific Atlanta, Magnavox and all specialized cable equipment available for shipment within 24 hours. For fast service MC/VISA or C.O.D. telephone orders accepted. 60 Day Guarantee (Quantity Discounts). Send self-addressed Stamped envelope.



C.O.D. ORDERS
ACCEPTED



CABLE-TRONICS, INC.

1304 E. Algonquin Road Suite 501
Algonquin, Illinois 60102

DESCRAMBLERS, cable TV converters, lowest prices, guaranteed, best quality, special Sacramento units, **CNC CONCEPTS, INC.**, Box 34503, Minneapolis, MN 55434. 1 (800) 535-1843.

MICROWAVE antenna — tunable 1.9 — 2.7GHZ TV dish systems under \$80.00. SASE, **SUNEXX**, PO Box 286, Anguilla, MS 38721.

FREE catalog. Interfaces for IBM compatibles. Digital I/O 48 TTL lines (2ea. 8255s) \$69.95, 16 ch. analog input 0 to 5v 8 bit. \$89.95. **JOHN BELL**, 1381 Saratoga St., Minden, NV 89423. (702) 267-2704.

WHY retire to FLA? Over half of North Carolina retirees came from Florida — learn why! North Carolina golf & lake homesites from only \$10,900. Free literature. 1 (800) 768-7358.

ANTIQUE RADIO CLASSIFIED

Free Sample!

Antique Radio's
Largest Circulation Monthly.
Articles, Ads & Classifieds.



6-Month Trial: \$15. 1-Yr: \$27 (\$40-1st Class).
A.R.C., P.O. Box 802-L9, Carlisle, MA 01741

SURVEILLANCE — Audio/video/infra-red/laser equipment. Industrial or private. 500 item catalog \$7.00. **SECURITY SYSTEMS**, 3017G Hudson Pl., New Orleans, LA 70131.

DESCRAMBLING, new secret manual. Build your own descramblers for **cable and subscription TV**. Instructions, schematics for SSAVI, gated sync, sinewave, (HBO, Cinemax, Showtime, UHF, adult) \$12.95, \$2.00 postage. **CABLETRONICS**, Box 30502R, Bethesda, MD 20824.

ROBOTICS! Engines! Inventions! Muscle wires contract with surprising strength when powered. Send business SASE for latest flyer. **MONDO-TRONICS** c/o RE, 2476 Verna Ct., San Leandro, CA 94577.

FREE cable and satellite descrambler plans. Send self addressed stamped envelope. **MJM INDUSTRY**, Box 531, Bronx, NY 10461-0208.

CATALOG: hobby/broadcasting/HAM/CB: Cable TV, transmitters, amplifiers, surveillance devices, computers, **more!** **PANAXIS**, Box 130-F7, Paradise, CA 95967.

VIDEOCIPHER II/scanner/cable/satellite modifications books. Catalog — \$3.00. **TELECODE**, PO Box 6426-RE, Yuma, AZ 85366-6426.

PEN transmitter: Sensitive micro FM transmitter housed inside standard size pen. Latest surface mount technology. Complete kit and instructions \$44.95. **MICRONIC-INT.**, Box 5726, Sherman Oaks, CA 91413.

REMOTE CONTROL KEYCHAIN



Complete w/mini-transmitter and +5 vdc RF receiver Fully assembled including plans to build your own auto alarm Quantity discounts available

\$24.95 Check, Visa or M/C Add \$ 3 shipping

VISITECT INC. BOX 5442, SO. SAN FRAN., CA. 94080
(415) 531-8425 Fax (415) 531-8442

PLANS AND KITS

DAZER personal protectors! Lasers! AM/FM/Infrared transmitters! Detectors! More! Kits/assembled. Catalog \$2.00. **QUANTUM RESEARCH**, 16645-113 Avenue, Edmonton, Alberta T5M 2X2.

SMD How to use surface mount technology. Build ultra miniature projects. Plans included free, infra red control, and an interesting light display. Send \$15.00 to **CHARLIE'S VIDEO**, Dept. SRT, PO Box 7782, La Sierra, CA 92503.

CABLE equipment top quality, best prices, warranty, satisfaction guaranteed, Scientific Atlanta/Jerrold. Deluxe combo \$189.00. Standard combo \$169.00. Check/money order/COD: (301) 829-1521. **CABLEPRO**, 14703-E Baltimore Ave., Suite 256, Laurel, MD 20707. No Maryland sales!

SUPER low prices on computers, motherboards, hard and floppy drives, add-on cards. We have everything. Full line of test equipment at unbeatable prices. Call for free catalog. **APPLIED ELECTRONIC RESEARCH, INC.**, Hollywood, FL (305) 987-9785.

PERFECT CABLE CONNECTION !!

Perfect Cable Connection is totally committed to customer satisfaction. Our primary concern is to provide you with the highest quality converters and descramblers at the lowest cost. We employ full time technicians to insure hassle free service and troubleshoot any situation. Call us today and let us prove to you why we are the Perfect Cable Connection.

- 6 months 100% parts & labor
- 24 months warranty available
- Full technical support
- On-line computer system
- 30 days money back guarantee
- Most orders shipped within 24 hours
- Visa, M/C, AMEX - 5%
- Dealers welcome
- C.O.D.

Jerrold 400 DRX 3 DIC WR 1 119 5 89 10 79 20 69 50 65 100 CALL	SA 85-36 WR 1 225 5 205 10 185 20 170 50 CALL 100 CALL	Regal RC 83 WR 1 89 10 69 20 65 50 60 100 55	'New' • 99 Ch capacity • Wireless remote • Automatic line tuning • Parental lock • Made in Japan • Super small • Favorite memory channels	Zenith ZTACS All models Call for prices	CRX 5000 IM WR 1 119 5 99 10 79 20 69 50 CALL 100 CALL
Filters 1 CALL 10 CALL 5 CALL 20 CALL 50 CALL 100 CALL	Jerrold 450 DRZ 3 DIC WR 1 129 5 99 10 89 20 79 50 CALL 100 CALL	SA 8500-311 WR 1 199 5 175 10 150 20 CALL 50 CALL 100 CALL			
Jerrold 400 DRX 3105 WR 1 55 5 49 10 45 50 40	TB-3 1 75 10 48 20 43 50 39 100 35	SA-3B 1 75 10 48 20 43 50 39 100 35	Jerrold 450 DRZ 3 WR 1 68 10 55 20 45 50 40		FTB-3 1 99 10 79 20 65 50 CALL 100 CALL

**WE WILL MEET OR BEAT ANY ADVERTISED PRICE
IN THIS MAGAZINE.**

PERFECT CABLE CONNECTION

702-358-2763
2209 Oddie Blvd., Suite 321
Spark, NV 89431

**WARNING!
CABLE BOX DEALERS**

**Consider the facts before you buy
after-market cable equipment**

An industry standard defines 25% of all after-market cable boxes do not work when first tested...

All wholesalers advertise low prices...but low prices are not enough. Any price is too high if you're without technical support or quality control.

Now consider that your success as a dealer depends on the satisfaction of your customers.

Wholesale Cable Supply offers services that are near a defined science. And we guarantee 100% satisfaction.

- Monthly Special
- Guaranteed Low Prices
 - State-of-the-Art technical support
 - Top Quality Tested Products
 - Dealer Market Support
- WHOLESALE CABLE SUPPLY**
Low Price is only the beginning
1-800-926-6836
- TB-3 or SA-3B
10 lot 48
20 lot - 43
50 lot - 39
100 lot - 39
- Z-TAC
10 lot - 149
- 723 CAMINO PLAZA, STE. 108, SAN BRUNO, CA 94066

HYPNOTIZE or Relax electronically! Alpha/meditation goggles. Complete kit \$53.00. Free information. **MARK WORLEY**, Box 261113, San Diego, CA 92196.

SURVEILLANCE transmitter kits! Four models of each; telephone, room, combination telephone/room transmitters tune from 65 to 305 MHz. Catalog with **Popular Communications and Popular Electronics** book reviews of "Electronic Eavesdropping Equipment Design," \$2.00. **SHEFFIELD ELECTRONICS**, 7223 Stony Island Ave., Chicago, IL 60649-2806.

DISTINCTIVE RING SWITCH

Add additional phone numbers to a single line with the new Distinctive Ringing service from the phone company. RingDirector detects ring patterns and routes calls to phones, answering machines, FAX's or modems. 2-port \$89. 4-port \$149. S/H \$5. 1-800-677-7969 FAX 516-676-9225

EXCELLENT TECHNOLOGY
69 Smith Street, Glen Head, NY 11545

BUILD from simple materials, phenomenal economy carburetor. Detailed plans for five versions. Good science project. Send \$20.00 cheque, money order or Visa to: **VALLEY MICROWAVE**, Station C, Bear River, Nova Scotia, Canada B0S 1B0 or phone (902) 467-3577.

POWERFUL single-chip FM voice transmitter, size of a postage stamp, transmits to any FM radio up to one mile away. Complete kit \$19.95 + \$2.00 S&H. **HERTZ MICRODEVICES**, Box 41771-D, LA, CA 90041.

SURVEILLANCE electronics, plans, kits, assembled. Catalog \$4.00. **S&S ELECTRONICS**, PO Box 36505-123R, San Jose, CA 95158.

TBC frame synchronizer kits for 1/2 and 3/4 inch VCRs \$595.00 to \$1,895.00 **ROGUE RESEARCH**, (503) 582-4324, PO 729, Rogue River, OR 97537.



TUBES - 2000 TYPES DISCOUNT PRICES!

Early, hard-to-find, and modern tubes. Also transformers, capacitors and parts for tube equipment. Send \$2.00 for 28 page wholesale catalog.

ANTIQUE ELECTRONIC SUPPLY
6621 S. Maple Ave. • Tempe, AZ 85283 • 602/820-5411

UNIQUE concept sends VCR signals over existing telephone wires in home. No expensive transmitters, receivers. Simply plugs into standard telephone outlets, doesn't interfere with telephone service. Play TV games in one room, while others watch movies in another. For video, bulletin boards, security, remote controls, computer networks, and more. Build a simple **VCR extender**. Guide, complete with transmission science, \$19.95. **JZO RESEARCH**, Box 28131, Minneapolis, MN 55428.

THE ultimate subwoofer enclosure guide. Complete information on construction methods, materials and calculating proper design parameters. Send \$5.99 to **STUART AUTOMATION/5**, 6169 St. Andrews Rd., Suite 243, Columbia, SC 29212.

SATELLITE TV

FREE catalog — Lowest prices worldwide, save 40 — 60%. Systems, upgrades, parts, all major brands factory fresh and warrantied. **SKYVISION**, 2009 Collegeway, Fergus Falls, MN 56537. 1 (800) 334-6455.

VIDEOCYpher II descrambling manual. Schematics, video and audio. Explains DES, Eprom, Clonemaster, 3Musketeer, Pay-per-view (HBO, Cinemax, Showtime, adult, etc.) \$16.95, \$2.00 postage. Schematics for Videocypher Plus, \$20.00. Schematics for Videocypher 032, \$15.00. Collection of software to copy and alter Eprom codes, \$25.00. **CABLETRONICS**, Box 30502R, Bethesda, MD 20824.

AMAZING SCIENTIFIC & ELECTRONIC PRODUCTS

LASERS AND SCIENTIFIC DEVICES

VRL2K	3mw Vis Red Laser Diode System Kit	\$159.50
LLIS1K	Laser Beam "Bounce" Listener Kit	\$199.50
LHC2K	Visible Simulated 3 Color Laser Kit	\$44.50
LC7	40 Watt Burning Cutting Laser Plans	\$20.00
RUB4	Hi Powered Pulsed Drilling Laser Plans	\$20.00
LGU40	1 to 2mw HeNe Vis Red Laser Gun Assembled	\$199.00
LLS1	Laser Lite Show - 3 Methods Plans	\$20.00
S05K	See in the Dark Kit	\$299.50
EML1K	Electromagnetic Coil Gun Kit	\$69.50
MCP1	Hi Velocity Coil Gun Plans	\$15.00
LEV1	Levitating Device Plans	\$10.00
EH1	Electronic Hypnotism Techniques Plans	\$10.00

HIGH VOLTAGE AND PLASMA DISPLAY DEVICES

HVM7K	75,000 Volt DC Variable Output Lab Source Kit	\$149.50
IOG3K	Ion Ray Gun Kit, project energy without wires	\$69.50
NIG9K	12V/115 VAC HI Out Neg Ion Generator Kit	\$34.50
EMA1K	Telekinetic Enhancer/Electric Man Assembled	\$99.50
LGSK	Lightning Display Globe Kit	\$54.50
BTC1K	Worlds Smallest Tesla Coil Kit	\$49.50
BTC3K	250KV Table Top Tesla Coil Kit	\$249.50
BTC5	1.5 Million Volts Tesla Coil Plans	\$20.00
JL3	Jacobs Ladder - 3 Models Plans	\$15.00
GRA1	Anti Gravity Generator Plans	\$10.00
PFS20	Plasma Fire Saber Assembled	\$69.50
DPL20	Dancing Plasma to Music and Sounds Assembled	\$79.50

SECURITY AND PROTECTION DEVICES

ITM10	100,000 Volt Intimidator up to 20' Assembled	\$129.50
IPG70	Invisible Pain Field Blast Wave Gun Assembled	\$74.50
PSP4K	Phasor Sonic Blast Wave Pistol Kit	\$59.50
LIST10	Infinity Xmr, Listen in Via Phone Assembled	\$199.50
TAT30	Automatic Tel Recording Device Assembled	\$24.50
VWPM7K	3 Mi. FM Auto Tel Transmitter Kit	\$49.50
FMV1K	3 Mi. FM Voice Transmitter Kit	\$39.50
HOD1K	Homing/Tracking Beeper Transmitter Kit	\$49.50

EASY ORDERING PROCEDURE TOLL FREE 1-800-221-1705

or 24 HRS ON 1-603-673-4730 or FAX IT TO 1-603-672-5406
VISA, MC, CHECK, MD IN US FUNDS. INCLUDE 10% SHIPPING. ORDERS \$100.00 & UP ONLY ADD \$10.00. CATALOG \$1.00 OR FREE WITH ORDER.

INFORMATION UNLIMITED
P.O. BOX 716, DEPT. R3, AMHERST, NH 03031

MCM Electronics OUTSHINES the rest...



For more information or a FREE subscription to our catalog call TOLL FREE

1-800-543-4330

Source No. RE-71



MCM ELECTRONICS
650 CONGRESS PARK DR.
CENTERVILLE, OH 45459-4072
A PREMIER Company

CABLE TV EQUIPMENT

Converters, Remote Controls, Descramblers, CD Players.



JERROLD-OAK-SCIENTIFIC ATLANTA-HAMLIN
ZENITH MANY MORE CALL TODAY!

- ✓ Only quality products sold ✓ Easy to use
- ✓ Satisfaction guaranteed ✓ Knowledgeable sales staff
- ✓ Most orders shipped within 24 hours

CALL FOR YOUR FREE CATALOG

MC 1-800-228-7404 **VISA**

MAKE THE CONNECTION

WITH
NU-TEK ELECTRONICS

5114 Balcones Wood Dr.#307 Dept.298
Austin, TX. 78759

CABLE TV Secrets — the outlaw publication the cable companies tried to ban. HBO, Movie Channel, Showtime, descramblers, converters, etc. Suppliers list included. \$9.95. **CABLE FACTS**, Box 711-R, Pataskala, OH 43062.

DO it yourself, systems, upgrades, major brands discounted, save 30% — 60%. Lowest prices anywhere. L.J.H. INC, call Larry at (609) 596-0656.

THIS IS A REGULAR CLASSIFIED AD WITH A TINT BACKGROUND. To have your ad appear like this one, the cost is \$3.90 per word.

IMPOSSIBLE CABLE SYSTEMS!

- ◆ Zenith PZ ◆ New Pioneer ◆ Starcom 6&7 ◆ Standard Units
- ◆ New Generation of TRIMODES & SB'S
- ◆ Quantity prices start at **\$25 each.**

Dealers only Call 1-800-933-2242
Digital Engineering Company of America

EDUCATION & INSTRUCTION

F.C.C. Commercial General Radiotelephone license. Electronics home study. Fast, inexpensive! "Free" details. **COMMAND**, D-176, Box 2824, San Francisco, CA 94126.

LEARN IBM PC assembly language. 80 programs. Disk \$5.00. Book \$18.00. **ZIPFAST**, Box 12238, Lexington, KY 40581-2238.

COMPLETE course in electronic engineering. Eight volumes. Includes all necessary math and physics. Free brochure. **BANNER TECHNICAL BOOKS**, 1203 Grant Avenue, Rockford, IL 61103.

CABLE DESCRAMBLERS OAK M35B COMBO \$39.95

Jerrold, Zenith, Hamlin, Sci. Atlanta, Pioneer & MORE! OUR PRICES ARE BELOW WHOLESALE!

CABLE PLUS

14417 Chase St. #481-A Panorama City, CA 91402
1-800-822-9955 • Other info. 1-818-785-4500
NO CALIF. SALES — DEALERS WANTED

INVENTORS

INVENTORS! Can you patent and profit from your idea? Call **AMERICAN INVENTORS CORPORATION** for free information. Over a decade of service 1 (800) 338-5656. In Canada call (413) 568-3753.

ECC

continued from page 46

go to both D/A converters, IC21 and IC22. To write the information to IC21 without disturbing the contents of the other D/A converter, the CPU must output a 252 to I/O port 54 to lower Q1 and Q2 of IC16, followed by a 255 to I/O port 54 to return the control signals to their inactive state.

The function of the D/A converters in the circuit are to provide a DC offset to the analog input circuitry to compensate for the DC offset produced by each ECG electrode on the patient's skin. Since the offset, in general, is different for each input lead each time the system is connected to a patient, a means to measure the offset must be provided. That is accomplished by performing a series of calibration measurements just prior to making the ECG measurements.

Next time we will continue with the construction and operation of the ECG device. **R-E**

12" Subwoofer Box

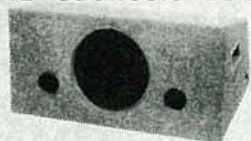

The perfect high volume cabinet for dual voice coil subwoofers. Box comes with pre-cut woofer and port holes. Cabinet volume: 2 cu. ft. with dual ports. Charcoal carpet. Dimensions: 13" (H) x 13" (D) x 30" (W). Net weight: 29 lbs.

#RJ-260-495 **\$59⁹⁰** Each

12" Pioneer Subwoofer



PIONEER

12" super duty, dual voice coil subwoofer. 30 oz. magnet, 2" voice coil. 100 watts RMS, 145 watts max power handling capability. 6 ohm impedance (4 and 8 ohm compatible). Sensitivity: 89 dB 1W/1M. Response: 25-700 Hz. QTS= .31, VAS= 10.3 cu ft. Net weight: 6 lbs. Pioneer #A30GU30-55D.

#RJ-290-145 **\$39⁸⁰** **\$36⁸⁰**
(1-3) (4-up)

800 Hz Horn



Piezo midrange/tweeter driver unit. Response: 800-20 KHz. Power handling capability: 20-30 volts (approximately 50 watts RMS). Sensitivity: 93 dB, 2.83V/1M. 4" round. Motorola #KSN1086.

#RJ-270-085 **\$25³⁰** **\$23⁹⁵**
(1-3) (4-up)

18" Eminence Woofer

Professional driver for use in auditorium and studio sound systems. Giant 100 oz. magnet. 250 watts RMS, 350 watts max power handling capability. fs= 30 Hz, QMS= 3.17, QES= .373, QTS= .33, VAS= 10.5 cu ft. SPL= 95 dB 1W/1M. Net weight: 29 lbs.



EMINENCE

#RJ-290-200 **\$99⁸⁰** **\$93⁴⁰**
(1-3) (4-up)

12" Pyle Woofer



PYLE

12", 70 oz. magnet woofer. 2-1/2" voice coil. 105 watts RMS, 155 watts max power handling capability.

#RJ-292-050 **\$62⁹⁰** **\$59⁸⁰**
(1-5) (6-up)

5-1/2" Cone Midrange

Original Sanyo high end system midrange. Large 5" paper cone with gold look dust cap. Heavy 12 oz. magnet. 1" ferro fluid cooled voice coil. 50 watts RMS, 75 watts max. Sanyo part #S12H10. Net weight: 1-1/2 lbs.



SANYO

#RJ-281-100 **\$5⁹⁵** **\$3⁹⁵**
(1-9) (10-up)

Subwoofer Crossover Network

Super duty, 200 watt RMS power handling capability. Designed specially for dual voice coil subwoofer systems. 12 dB per octave roll-off at 150 Hz into 8 ohms. Crossover also features a set of outputs for use with your existing speaker system. Network is totally passive, requiring no power source of its own.



#RJ-260-220 **\$28⁸⁰** **\$24⁹⁵**
(1-5) (6-up)



Parts Express
INTERNATIONAL INC.

FREE CATALOG

•15 day money back guarantee • \$15.00 minimum order • We accept Mastercard, Visa, Discover, and C.O.D. orders. • 24 hour shipping • Shipping charge = UPS chart rate + \$1.00 (\$3.00 minimum charge) • Hours 8:30 am - 7:00 pm EST, Monday - Friday • 9:00 am - 2:00 pm Saturday. Mail order customers, please call for shipping estimate on orders exceeding 5 lbs. Foreign customers please send \$5.00 U.S. funds for catalog postage.

CALL TOLL FREE

1-800-338-0531

WANTED

INVENTIONS/ new products/ideas wanted: call TLCI for free information 1 (800) 468-7200 24 hours/day - USA/Canada.

INVENTORS: We submit ideas to industry. Find out what we can do for you. 1 (800) 288-IDEA.

NEED help with your electronic project, PCB assembly/artwork? Write to T.S., PO Box 5275, Flint, MI 48505.

I'LL HAVE MINE DESCRAMBLED

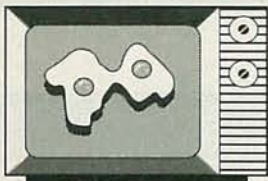

If you find a better deal, We'll beat it! **JERROLD • TOCOM • HAMLIN • OAK • SCIENTIFIC ATLANTA • ZENITH** • ask about our warranty program C.O.D. Visa, M/C, AM. EX. welcome. • **FREE CATALOG** • **FREE CALL** • **OPEN SATURDAYS**

1 800 562-6884

VIDEO TECH
3702 S. Virginia St. Ste. 160-304
Reno, NV 89502

INVENTORS! Your first step is important. For free advice, call **ADVANCED PATENT SERVICES**, Washington, DC, 1 (800) 458-0352.

TRAVEL! High income! Radio officers wanted for shipboard employment. Must have FCC second telegraph license. Rae Echols, **AMERICAN RADIO ASSOCIATION**, 5700 Hammonds Ferry, Linthicum, MD 21090.

WIRELESS RCA FM mike, oldstyle, with dangling antenna, for parts. Collect (416) 499-6367.

FREE CATALOG! 1-800-648-7938

JERROLD HAMLIN OAK ETC CABLE TV DESCRAMBLERS

- Special Dealer Prices!
- Compare our Low Retail Prices!
- Guaranteed Prices & Warranties!
- Orders Shipped Immediately!

REPUBLIC CABLE PRODUCTS, INC.

4080 Paradise Rd. #15, Dept RE791
Las Vegas, NV 89109
For all other information (702) 362-9026

BUSINESS OPPORTUNITIES

MAKE \$50/hr working evenings or weekends in your own electronics business. Send for free facts. **MJME INDUSTRY**, Box 531, Bronx, NY 10461-0208.

YOUR own radio station! AM, FM, TV, cable. Licensed/unlicensed. **BROADCASTING**, Box 130-F7, Paradise, CA 95967.

EASY work! Excellent pay! Assemble products at home. Call for information (504) 641-8003 Ext. 5192.

MAKE \$\$\$! Become an American electronics dealer! Profit opportunities since 1965. Call **SCOTT PRUETT**, 1 (800) 872-1373.

Great money in VCR repair!

Home study. Learn high-profit repairs without investing in high-tech instruments. **FREE BOOKLET: 800-223-4542.**

Name _____
Address _____
City _____ State _____ Zip _____
The School of VCR Repair, 2245 Perimeter Park, Dept. VG342, Atlanta, Georgia 30341



LET the government finance your small business. Grants/loans to \$500,000. Free recorded message: (707) 449-8600. (KS1).

MAKE \$75,000 to \$250,000 yearly or more fixing IBM color monitors (and most brands). No investment. Start doing it from your home. (A telephone required.) Information, USA, Canada \$1.00 cash. US funds. other countries \$8.00 **RANDALL DISPLAY**, Box 2168-R, Van Nuys, CA 91404 USA.

BIG PROFITS ELECTRONIC ASSEMBLY BUSINESS

Start home, spare time. Investment knowledge or experience unnecessary. **BIG DEMAND** assembling electronic devices. Sales handled by professionals. Unusual business opportunity.

FREE: Complete illustrated literature
BARTA RE-00 Box 248
Walnut Creek, Calif. 94597

ZENITH & TOCOM SPECIALS

SUPER Zenith (Z-TAC) converters (flashing)... \$179.00. **Zenith "turn-on"** module... \$49.00. **Tomcom 5503(A)** converters... \$159.00. **Tomcom** (add-on) descramblers... \$79.00. **Tomcom (5503-VIP & 5507)** "turn-on" chips... \$49.00. **Tomcom 5507** security screw removal bits... \$22.00. **CINEPLEX VIDEO GROUP**, 1 (800) 726-4627.

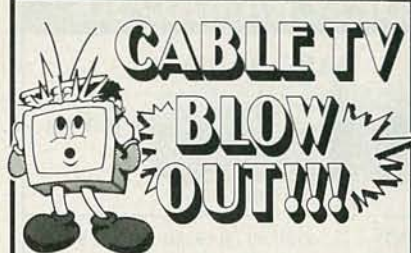

CHOOSE FROM THE FOLLOWING PACKAGES:

PKG. # 1...

10 PANASONIC 1453G CONVERTERS \$65^{EA.}

PKG. # 2...

8 SCIENTIFIC ATLANTA 8536+ COMBINATIONS \$175^{EA.}

PKG. # 3...

5 SCIENTIFIC ATLANTA 8580 COMBINATIONS \$215^{EA.}

PKG. # 4...

10 MIX AND MATCH ADD-ONS \$45^{EA.}

ALL EQUIPMENT IS BRAND NEW, FACTORY FRESH !!!

CALL (800) 234-1006 **CABLE READY** Company
for additional information and a catalog.

Cable Descramblers

New Auto Tri-Bi guaranteed no flashing \$165.00

SB-3.....	\$99.00	ZENITH SUPER	
TRIMODE.....	\$109.00	SAAVI.....	\$199.00
HAMLIN.....	\$99.00	TOCOM.....	\$319.00
SCIENTIFIC-		EAGLE.....	\$119.00
ATLANTA.....	\$119.00	COPY GUARD.....	\$59.95
OAK M35B....	\$99.00	STARGATE 2000...	\$88.00
ZENITH.....	\$175.00		

M.D. Electronics will match or beat any advertised wholesale or retail price.

Your best buys and warranties for cable converters and descramblers start with a FREE catalog from MD

For Information Call

402-554-0417

To order or request a free catalog

1-800-624-1150



M.D. ELECTRONICS

875 SO. 72nd St.
Omaha, NE 68114

EXCELLERATOR™ Series

CABLE CONVERTERS
WHEN QUALITY COUNTS

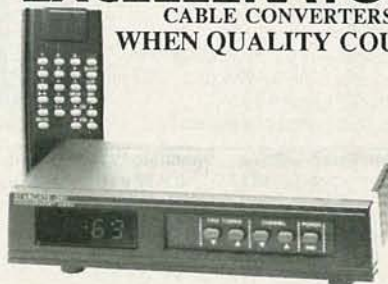

New Dynatrack™ fine tuning provides unmatched picture quality
550 Mhz tuner provides 83 channel capacity
Sleep timer for automatic shut off within 15-90 minutes
2/3 switchable HRC / IRC / Standard Switchable
2 Year warranty, Last channel recall, Favorite channel select, Scan
Double vented high efficiency transformer for cool performance
Stargate-2001 \$99.00
Stargate-550XL \$119.00 With Volume Control

Don't settle for anything less.



C.O.D.

BY ORDERING CABLE TV EQUIPMENT FROM M.D. ELECTRONICS THE PURCHASER AGREES TO COMPLY WITH ALL STATE AND FEDERAL LAWS REGARDING PRIVATE OWNERSHIP OF CABLE TV EQUIPMENT. IF YOU ARE UNSURE OF THESE LAWS CHECK WITH YOUR LOCAL OFFICIALS.

CIRCLE 53 ON FREE INFORMATION CARD

CABLE T.V. DESCRAMBLERS

BASE BAND



\$399.00

DQN7V.....\$120.00 SA8580.....\$299.00
TRIMODE.....\$119.00 SB3.....\$85.99
ZENITH 1086.\$249.00 PIONEER.....\$399.00
DQN7.....\$99.00 JERROLD DRX\$99.00

MANY MORE...CALL OR WRITE FOR FREE FAST INFORMATION.

YOUR BEST BUY'S & WARRANTIES FOR CABLE CONVERTERS AND DESCRAMBLERS START WITH A FREE CATALOG FROM:

WORLDWIDE CABLE

7491 C-5 N. Federal Hwy.
Suite #142
Boca Raton, FL 33487

ORDERS AND CATALOGS CALL TOLL FREE

1-800-772-3233



C.O.D.



BY ORDERING CABLE TV EQUIPMENT FROM WORLDWIDE CABLE THE PURCHASER AGREES TO COMPLY WITH ALL STATE AND FEDERAL LAWS REGARDING PRIVATE OWNERSHIP OF CABLE TV EQUIPMENT, IF YOU ARE UNSURE OF THESE LAWS CHECK WITH YOUR LOCAL OFFICIALS.

CIRCLE 184 ON FREE INFORMATION CARD

FREE CATALOG! 1-800-348-7659

ELECTRONIC COMPONENTS, AUDIO, VIDEO, TELEPHONE, ANTENNA & ACCESSORIES.

Polytron Corp., 20 Cherokee Rd., P.O. Box 1033, East Brunswick, NJ 08816

Video Transceiver

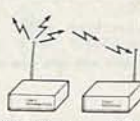

Video Transmitter Video Receiver

To Order
\$55⁹⁵ \$28⁹⁵

*ICE APPROVED VIDEO TRANSMITTER & RECEIVER
*SENDS VIDEO SIGNAL TO MULTIPLE TV'S (EQUIPPED IN RECEIVER)

Digital Video Stabilizer



ADAPTER (60 Hertz) (60 Hertz)

To Order
\$36⁹⁵

*STOP RENTAL MOVIE PICTURE PROBLEMS
*COMPLETED REMOVES FLASHING
*OPERATES AUTOMATICALLY

WARNING: Use of this device to duplicate copyrighted video material may be subject to criminal, federal and state copyright laws. We do not encourage nor bear responsibility for such use.

BUY BONDS

*****PRESENTING*****
CABLE TV DESCRAMBLERS
*****STARRING*****
JERROLD, HAMLIN, OAK
AND OTHER FAMOUS MANUFACTURERS

- FINEST WARRANTY PROGRAM AVAILABLE
- LOWEST RETAIL/WHOLESALE PRICES IN U.S.
- ORDERS SHIPPED FROM STOCK WITHIN 24 HRS.
- ALL MAJOR CREDIT CARDS ACCEPTED

FOR FREE CATALOG ONLY **1-800-345-8927**
FOR ALL INFORMATION **1-818-709-9937**

PACIFIC CABLE CO., INC.
7325 1/2 Reseda Blvd., Dept. 2104
Reseda, CA 91335

CABLE TV "BOXES"

Converters—Descramblers
Remote Controls—Accessories

- * Guaranteed Best Prices *
- * 1 Year Warranty — C.O.D.'s *
- * Immediate Shipping *
- * FREE CATALOG *

Call or Write
NAS/TRANSWORLD
3958 Northlake Blvd., Suite 255
Lake Park, FL 33403
1-800-442-9333



CABLE TV DESCRAMBLER LIQUIDATION!

FREE CATALOG!
Hamlin Combos \$44, Oak M35B \$60 (min. 5), etc.
WEST COAST ELECTRONICS
For Information: 818-709-1758
Catalogs & Orders: 800-628-9656

PAY TV AND SATELLITE DESCRAMBLING ALL NEW 1991 EDITION

Our best yet. The very latest in descrambling circuits, bypasses, turn-ons for cable, wireless and satellite. Only \$14.95. Other pay TV editions, Vol. 1 (Basics of All Systems) \$14.95, 1989 Edition \$14.95. Build satellite systems under \$600 \$12.95. Wireless Cable Handbook \$9.95. Army 3/\$29.95 or 5/\$44.95. Scrambling News Monthly has all info on the new "Plain Vanilla" descramblers which emulate B-Mac, VCI, Plus and Orion. \$19.95/yr. All new catalog \$1.

Scrambling News, 1552 Hertel Ave.,
Buffalo, NY, 14216. COD'S ARE OK. (716) 874-2088

SOLDERLESS PROTOTYPING BOARDS

FEATURES

- Color coordinates for easy recognition
- Insertion wire: 20-29 AWG (0.3 - 0.8 mm)
- Over 10,000 insertion cycles
- Accepts all standard components

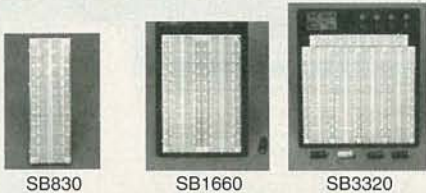

EasyTech Order #	Price 1-9	Price 10+	Dimensions (in.) L x W x H	Dist. Strips	Dist. Points	Term. Strips	Term. Points	Binding Posts
SB200	2.99	2.49	6.5 x .37 x .4	2	100 x 2	0	0	0
SB400	4.89	4.39	3.3 x 2.2 x .4	2	100	1	300	0
SB630	5.49	4.99	6.5 x 1.4 x .4	0	0	1	630	0
SB830	6.49	5.99	6.5 x 2.2 x .4	2	200	1	630	0
SB1360	12.49	11.99	8.5 x 3.9 x 1.2	1	100	2	1,260	2
SB1660	17.49	16.99	8.5 x 5.1 x 1.2	4	400	2	1,260	3
SB2390	22.49	21.99	9.1 x 6.9 x 1.2	5	500	3	1,890	4
SB3220	31.49	30.99	9.5 x 8.3 x 1.2	7	700	4	2,520	4

EPROMS			DRAMS			STATIC RAMS			MICROS		
Order #	Price	Prog.	Order #	Price	Desc.	Order #	Price		Order #	Price	
TMS2532	6.95	25V	MK4027N2	.75	4x1	2101	1.65		8031	3.55	
2708	4.75	25V	4116-20	.85	16x1	2114L25	1.15		8080A	2.75	
2716	3.45	25V	4416-12	2.25	16x4	2147-3	3.75		8085A	2.95	
2716-1	3.95	25V	4164-10	1.95	64x1	2148-3	1.95		8086	4.45	
2732	3.95	25V	4164-15	1.75	64x1	2149-35	3.75		8088	4.25	
2732A25	3.45	21V	4164-20	1.25	64x1	5101	3.95		8237A5	4.15	
2732B45	4.25	12.5V	41464-12	2.75	64x4	6116LP3	2.95		8250	5.75	
2764-25	3.75	21V	41256-80	2.75	256x1	6116-3	2.45		8251A	2.25	
2764A25	3.25	12.5V	41256-12	2.15	256x1	6264LP10	4.95		8253	1.95	
27C64A15	3.75	12.5V	41256-15	1.95	256x1	6264LP15	3.95		8253-5	2.25	
27128A25	3.95	12.5V	514256-80	8.75	256x4	6264-10	4.75		8255A5	2.75	
27256-25	4.75	12.5V	514256-10	7.95	256x4	6264-15	3.75		8259-5	2.25	
27256-30	3.45	12.5V	511000-80	8.75	1Mx1	62256LP10	7.95		8275	18.95	
27C512-15	6.95	12.5V	511000-10	8.25	1Mx1	62256LP15	6.95		8284A	2.25	

Extensive range of parts & components in stock

Call to reserve your copy of our new 1991 catalog due in late July

CIRCLE 177 ON FREE INFORMATION CARD

STEEL ENCLOSURE SERIES

FEATURES

- Ventilation holes
- Self-adhesive feet included
- Front & rear panels: 1.3mm Aluminum Alodine (Painted White)
- Top & bottom covers: 0.9mm Phosphated Steel (Painted Black)

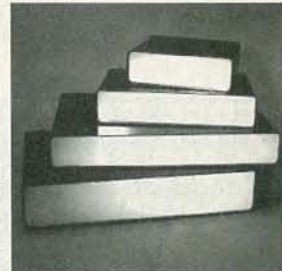

Order #	1-9	10+	Dimensions(WxDxH)	Weight
E3119A	12.95	11.95	8"x7"x2.5"	2.64 lbs.
E3119B	15.95	14.95	12"x7"x2.5"	3.74 lbs.
E3119F	19.95	18.95	17"x11"x2.5"	6.82 lbs.
E3119G	13.95	12.95	8"x7"x3.5"	2.86 lbs.
E3119K	24.95	23.95	17"x11"x3.5"	7.26 lbs.
E3119P	29.95	28.95	17"x11"x5.2"	7.7 lbs.

EASYTECH
THE ELECTRONICS SOURCE

2917 Bayview Drive • Fremont, CA 94538

Order Direct: 1-415-770-2345

Fax Direct: 1-415-770-2346

Monday-Friday, 7am - 5pm (PST)/10am-8pm (EST)

- VISA
 - MasterCard
 - COD—No personal checks, US funds (\$5.00 Charge)
 - USPS
 - UPS
 - Airborne Express
- Add 5% of total for shipping charges (\$3.00 min.)

We Have **QUALITY PARTS** • We Have **DISCOUNT PRICES** • We **SHIP FAST**

ALL ELECTRONICS CORP.

GEAR MOTOR

Everest & Jennings
24 W series High torque,
permanent magnet
gearhead motor with
replaceable brushes.
Rated for 24 Vdc;
operates fine on 12 Vdc.
We think these were originally built for
wheelchairs. 1/2" dual shaft on final drive.
Ratings: 12 Vdc 1.7 amps 220-290 rpm
24 Vdc 2.0 amps 445-470 rpm
Motor is 5 3/4" long X 3" diameter with 3.125"
square mounting bracket. Gear box is 3.37" long
X 3.2" wide. Shafts extend 0.75" to either side of
gear box. 9.5 lbs. **CAT# MOTG-16 \$25.00 each**



TOUCH DIMMER

The "brain"
part of the
"LITE
TOUCH"
touch
dimmer,
when connected to any lamp, will turn it on
and off and change the brightness level when
any metal part is touched. We don't have the
wiring harness that originally connected this
to the lamp, but we can provide a simple
hook-up diagram and instruction sheet. The
solid-state circuitry is contained in a thermo-
plastic box 1.91" X 3.11" X 0.835".
CAT# DMR-1 \$3.50 each



12 Vdc POWER PACK

12 Vdc 1 Amp. power pack. 8 ft.
2 conductor power cord on input.
22" cord with stripped and tinned pigtail
leads on output. 3.2" X 2.3" X 1.9".
CAT# DCTX-121 \$5.75 each

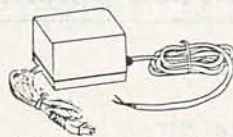

FLOURESCENT FIXTURE

Fixture for single mini bi-pin 6". 4 watt fluores-
cent lamp. Starter switch, sockets and ballast
are mounted on 7 1/4" X 3 1/4" metal plate.
Includes 8 foot power cord with strain relief.
Use with standard fluorescent lamp for display
lighting or with ultraviolet lamp for special ef-
fects or EPROM erasure. U.L. listed.
CAT# FLX-1 \$3.00 each



SWITCHES

Dip P.C. Pushbutton

ITT Schadow Digtast
Series SE
S.P.D.T. momentary
pushbutton. Mounts in
14 pin DIP configuration.
Designed for low current switching appli-
cations. Grey keycap is 0.68" X 0.67".
CAT# PB-28 \$1.00 each
10 for \$9.50 • 100 for \$85.00



Pushbutton Switch

SMK Manufacturing
0.47" square black pushbutton.
SPST normally open. 4 p.c. pins
for mounting. Ideal for low current
switching applications. **CAT# PB-29**
5 for \$1.00 • 100 for \$15.00



Rotary BCD Switch

EECO # 2310-02G
BCD 10 position
rotary switch. DIP configuration fits in
standard 8 pin I.C. socket. Right angle
style. Screwdriver actuation. 0.42" cube.
CAT# RDIP-2 \$1.75 each
10 for \$16.00 • 100 for \$145.00



Miniature Toggles

Rated: 3 amps @ 120 Vac
S.P.D.T. (ON-ON) P.C. mount
CAT# MTS-4PC \$1.00 each
10 for \$9.00 • 100 for \$80.00
S.P.D.T. (ON-ON) solder lugs
CAT# MTS-4 \$1.35 each
10 for \$12.50 • 100 for \$110.00
D.P.D.T. (ON-ON) solder lugs
CAT# MTS-8 \$1.75 ea. 10 for \$15.00
D.P.D.T. (ON-ON) P.C. mount
CAT# MTS-8PC \$2.00 ea. 10 for \$17.50



TELEPHONE KEYPAD

12 button telephone
keypad. Ivory finish.
2.83" x 2.2" x 0.58" thick.
Matrix encoded.
Ideal for telephone or
security keypad.
CAT# KPT-1 \$1.00 each • 10 for \$9.00



OPTO-SENSOR

TRW/Optron # OPB5447-2
IR emitter/sensor pair in
Rectangular package with
28" color coded leads.
CAT# OSR-4 2 for \$1.00



PHOTOFLASH CAPACITOR

Rubicon CE
210 Mfd 330 Volt
photoflash
capacitor.
0.79" dia.
X 1.1" high. These are new
capacitors that have been
prepped with 1.4" black and
red wire leads soldered to the
terminals. **CAT# PPC-210**
\$1.25 each • 10 for \$11.00
100 for \$100.00
Large quantities available.
Call for pricing.



RECHARGEABLE BATTERIES

6 Volt 1 Amp/Hour

Japan Storage Battery Co.
Portalac
PE6V1
6 Volt 1 Ah
rechargeable
sealed lead-acid
(gell cell). 2" X 1.635" X 2" ht.
Batteries are prepped with 5"
black and red leads terminat-
ed with 2 pin connector.
CAT# GC-61 \$4.75 each
10 for \$42.50



Nickel-Cad

AAA SIZE \$1.50 each
1.2 volts 180 mAh
CAT# NCB-AAA
AA SIZE \$2.00 each
1.25 volts 500 mAh
CAT# NCB-AA
AA SIZE \$2.20 each
WITH SOLDER TABS
CAT# NCB-SAA
C SIZE \$4.25 each
1.2 volts 1200 mAh
CAT# NCB-C
D SIZE \$4.50 each
1.2 volts 1200 mAh
CAT# NCB-D



HALL EFFECT SENSOR

Microswitch #SS41
Tiny, solid state switch
reacts instantly to
proximity of magnetic field.
Operates at extremely high speeds, up to
100 khz. Case size: 0.12" X 0.17" X 0.06"
thick. 4.5 Vdc to 24 Vdc supply voltage.
10 ma. sink type digital output. Operating
gauss - 15 to 40. P.C. leads.
CAT# HESW-2 75¢ each • 10 for \$6.50
100 for \$60.00 • 1000 for \$500.00



3 1/2" DISKETTES

Quality, double-sided
3 1/2" diskettes. These
diskettes were recorded,
but never used. Flip the
write-protect tab to off
position and use for your
own data storage
at a fraction of the cost of new diskettes.
CAT# DTS-1 \$1.00 each • 10 for \$9.00

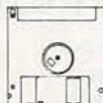

AUDIO SLIDE POT

Dual 1K audio.
3 1/2" long, 2 1/2" slide
CAT# ASP-1KD
Reduced to 50¢ each
100 for \$40.00



I.E.C. POWER CORD

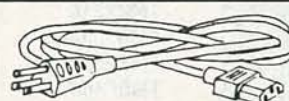

6 foot BLACK, SPH-386 jack to 3 prong
molded A.C. plug. Fits most computers,
computer terminals and test equipment.
CAT# LCAC-C6 \$3.00 each

FLASH ASSEMBLY

New compact flash
assembly from a
U.S. manufacturer of
cameras. Operates
on 3 Vdc and measures
2 1/2" x 1 1/4". Ideal for use as a strobe,
warning light or attention getter. Includes
hook-up diagram. **CAT# FSH-1 \$3.75 each**
10 for \$35.00 • 100 for \$325.00

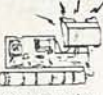

P.C. RELAYS

The following
relays all have
p.c. pins for
both input and
output as well
as quick-connect terminals
on the output. 1.5" X 1.05"
X 1.08". UL & CSA listed.



12 Vdc, SPDT
Potter & Brumfield #
T91R5D22-12-02
12 Vdc, 155 ohm coil,
Normally open contacts rated
20 amps. Normally closed
contacts rated 10 amps.
CAT# RLY-31 \$2.50 each
10 for \$22.50

12 Vdc, SPST N. O.
Potter & Brumfield #
T91R5D22-12-01
12 Vdc, 155 ohm coil,
S.P.S.T. normally open con-
tacts rated 30 amps.
CAT# RLY-32 \$2.00 each
10 for \$18.00

L.E.D.'s

Standard JUMBO
Diffused T 1-3/4 size (5 mm)

RED **CAT# LED-1**
10 for \$1.50 • 100 for \$13.00
GREEN **CAT# LED-2**
10 for \$2.00 • 100 for \$17.00
YELLOW **CAT# LED-3**
10 for \$2.00 • 100 for \$17.00

FLASHING LED
W/ built in flashing circuit
5 volt operation. T 1-3/4
(5mm)

RED \$1.00 each
CAT# LED-4 10 for \$9.50
GREEN \$1.00 each
CAT# LED-4G 10 for \$9.50
YELLOW \$1.00 each
CAT# LED-4Y 10 for \$9.50

LED HOLDER
Two piece holder.
CAT# HLED 10 for 65¢

KITS

L.E.D. FLASHER KIT

Two L.E.D.'s flash in
unison when a 9 volt
battery is attached.
This kit includes a
p.c. board, all the parts
and instructions to make a simple flash-
er circuit. A quick and easy project for
anyone with basic soldering skills.
CAT# LEDKIT \$1.75 per kit



L.E.D. CHASER KIT

Build this variable
speed led chaser.
10 leds flash
sequentially at
whatever speed
you set them for.
Easy to build kit includes pc board,
parts and instructions. Ideal for special
lighting effects, costumes, etc. Oper-
ates on 3 to 9 volts. PC board is 5" X
2.25". A great one hour project.
CAT# AEC \$6.50 each



STEPPING MOTOR CONTROLLER KIT

Learn about
stepping
motors while
building this
simple circuit.
Includes circuit board, stepping motor
and all parts except 12 Vdc power
supply. **CAT# SMKIT \$18.00 each**



METRONOME KIT

This simple device can be set to click
from 20 to 1,000 beats per minute.
Easy to build, includes circuit board, all
components and instructions. Oper-
ates on a 9 volt battery (not included).
CAT# METRO \$3.75 each



PHOTO RESISTOR

1,000 ohms bright light.
16K ohms dark.
0.182" dia. X .08" high. 0.18" long leads.
CAT# PRE-7 2 for \$1.00
100 for \$45.00 • 1000 for \$400.00



ORDER TOLL FREE 1-800-826-5432

FAX (818) 781-2653 • INFORMATION (818) 904-0524

Call Or Write For Our
Free 64 Page Catalog

Outside the U.S.A. send \$2.00
postage for a catalog.

Minimum Order \$10.00 • All Orders Can Be Charged To Visa, Mastercard
Or Discovercard • Checks and Money Orders Accepted By Mail • California, Add
Sales Tax • Shipping And Handling \$3.50 for the 48 Continental United States -
All Others Including Alaska, Hawaii, P.R. And Canada Must Pay Full Shipping •
Quantities Limited • No C.O.D. • Prices Subject to change without notice.

DISCOVER

VISA

MasterCard

MAIL ORDERS TO: ALL ELECTRONICS CORP • P.O. BOX 567 • VAN NUYS, CA 91408

CIRCLE 107 ON FREE INFORMATION CARD

JULY 1991

91

Perfectly Tuned for

Test/Measurement and Prototype Equipment

51-Piece Electronic Tool Kit

Tools Included in Kit:

- 10' measuring tape
- 5.25" needle nose pliers
- Electric tape
- Utility components box
- 6 piece precision screwdriver set
- 6" long tweezers
- 8 piece hex key wrench set
- 7" brush and scraper
- Digital Multimeter
- Brush
- 7" fine point probe
- Round needle file
- 10 piece screwdriver set: 6 Slotted & 4 Phillips
- 7" slotted probe
- Flat needle file
- 4.5" diagonal cutting pliers
- 6" adjustable wrench
- 30 Watt soldering iron
- 5.5" Stainless steel scissors
- Soldering stand
- Rosin core solder
- 5.25" Flat nose pliers
- Utility knife with extra blade
- Desoldering pump
- 5.25" Bent needle nose pliers
- Carrying case: 17.63"W x 12.5"D x 3.5"H



**24 Hour
Order Hotline
(415) 592-8097**

Global Specialties Protoboard® Design Station

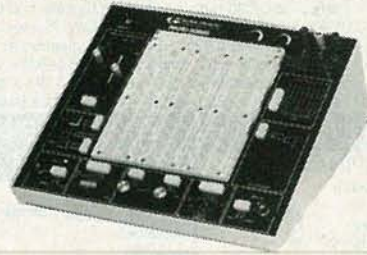

Features:

- Ideal for analog, digital and microprocessor circuits
- Triple DC regulated power supplies, +5V, +15V, -15V
- 8 logic indicators
- Function generator with sine, square, triangle and TTL waveforms
- Two debounced push-button switches
- Two SPDT slide switches, all leads available and uncommitted
- A total of 2520 uncommitted tie-points
- Potentiometers: one 1KΩ and one 10KΩ
- Includes power supply, instrumentation and breadboarding

MS305.....\$119.95

PB503.....\$299.95

Jameco Logic Pulser



- Compatible with TTL, DTL, RTL, HTL, HNIL, MOS and CMOS ICs. • 1MΩ Sync input impedance • Pulser mode output current: 10mA • Square wave current output: 5mA • Audible tone

LP540.....\$16.95

Jameco Logic Probe



- Max Frequency 80MHz • Minimum detectable pulse: 10ns • 120KΩ input impedance • Max. supply voltage: +25V • TTL threshold: (Lo)+0.8V ±0.1V (Hi) +2.3V ±0.2V • CMOS threshold: (Lo) 30% VCC ±10% (Hi) 70%VCC ±10%

MS104.....\$24.95

A.R.T. EPROM Programmer



- Programs all current EPROMs in the 2716 to 27512 range plus the X2864 EEPROM
- RS232 port • Software included

EPP.....\$199.95

UVP EPROM Eraser



- Erases all EPROM's • Erases 1 chip in 15 minutes and 8 chips in 21 min
- UV intensity: 6800 UW/CM²

DE4.....\$89.95

PROTOTYPING PRODUCTS Jameco Solderless Breadboards

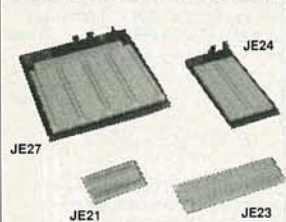

Part No.	Dim. L" x W"	Contact Points	Binding Posts	Price
JE21	3.25 x 2.125	400	0	\$4.95
JE23	6.5 x 2.125	830	0	\$6.95
JE24	6.5 x 3.125	1,360	2	\$12.95
JE25	6.5 x 4.25	1,660	3	\$17.95
JE26	6.875 x 5.75	2,390	4	\$22.95
JE27	7.25 x 7.5	3,220	4	\$32.95

Metex Digital Multimeters

General Specs:

- Handheld, high accuracy • AC/DC voltage, AC/DC current, resistance, diodes, continuity, transistor hFE
- Manual ranging w/ overload protection



- M3650 & M4650 only: • Also measure frequency and capacitance

- M4650 only: • Data hold switch • 4.5 digit

M3610	3.5 Digit Multimeter	\$59.95
M3650	3.5 Digit Multimeter w/Frequency & Capacitance	\$74.95
M4650	4.5 Digit w/Frequency, Capacitance and Data Hold Switch	\$99.95

Handheld Multimeter



- 3.5 digit LCD with automatic polarity indication
- AC/DC voltage measurement up to 500 volts
- AC/DC current measurement up to 200mA
- Resistance measurement up to 20MΩ • Continuity checker with audible tone • Diode and logic tester • Auto/manual range and data hold functions • All range protection and function indications

DMM905.....\$39.95

EPROMs - for your programming needs

Part No.	Price	Part No.	Price	Part No.	Price
TMS2516	\$4.25	2764-20	\$3.95	27256OTP	\$3.7
TMS2532-35	9.95	2764-25	3.75	27256-15	5.9
TMS2532A	7.95	2764-45	3.49	27256-20	5.2
TMS2564	5.95	2764A-20	3.95	27256-25	4.7
TMS2716	5.95	2764A-25	3.25	27C256-15	5.9
1702A	3.95	27C64-15	3.95	27C256-20	4.9
2708	6.95	27C64-25	3.25	27C256-25	4.4
2716	3.49	27128OTP	2.95	27512OTP	4.9
2716-1	3.95	27128-20	6.95	27512-20	6.9
27C16	4.25	27128-25	4.95	27512-25	5.9
2732	4.95	27128A-15	5.95	27C512-15	6.9
2732A-20	4.95	27128A-20	4.49	27C512-20	6.4
2732A-25	3.49	27128A-25	4.25	27C512-25	5.9
2732A-45	2.95	27C128-15	5.95	27C010-15	11.9
27C32	4.95	27C128-25	6.49	68766-35	9.9

Soldering and Desoldering Stations

- 60 Watt Analog Display Soldering Station • Electronic temperature control from 200° to 878°F • Cartridge heating element for a longer life of the soldering tip

XY1683.....\$69.95

- 30 Watt Electronic Temperature Controlled Desoldering Station • Electronic temperature control from 212° to 842°F • Self contained high rotary vacuum pump

XY999.....\$299.95



JAMECO

**24 Hour Order Hotline
(415) 592-8097**

FAX: (415) 592-2503
(415) 595-2664

• Partial Listing • Over 4000 Electronic and Computer Components in Stock!
CIRCLE 114 ON FREE INFORMATION CARD

Top Performance.

Computer Products and Electronic Components

Assemble Your own Computer Kit!

Jameco 16MHz 80386SX Desktop Computer Kit

Building your own computer provides you with a better understanding of components and their functions
 In-depth assembly instructions included
 Have your new computer assembled and running in an evening,
 using common tools
 Software included
 Purchase computer kits configured by Jameco or design your own

Jameco 16MHz 80386SX Desktop Computer Kit

Includes:
 80386SX Motherboard with
 2MB RAM (expandable to 8MB)
 101-key enhanced keyboard
 Multi I/O Card
 Toshiba 1.44MB, 3.5" DSHD floppy disk drive
 Baby sized desktop case
 200 Watt power supply
 DR DOS 5.0 by Digital Research and AMI diagnostic software



\$949.95
JE3816
 monitor/adaptor extra

Hard Drives



Conner (16-bit IDE)
CP3044 40MB 3.5" Low Profile.....\$399.95
CP3184 80MB 3.5"HH.....\$599.95
CP3104 100MB 3.5"HH.....\$649.95
ADP20 Host Adapter.....\$29.95

Relisys 14" VGA Color Monitor



- Max resolution: 720 x 480
- Bandwidth: 30MHz
- Input: DB15-pin (analog)

RE9513.....\$399.95

Jameco 16-bit VGA Card



- Supports VGA, EGA, CGA, MDA and Hercules modes • Comes with 256KB video RAM upgradable to 512KB (eight 41464-80) • Capable of 640 x 480 with 256 colors, 800 x 600 with 16 colors

VG2000.....\$149.95

JAMECO

24 Hour Order Hotline
(415) 592-8097

FAX: (415) 592-2503
 (415) 595-2664

1355 Shoreway Road
 Belmont, CA 94002

Look to Jameco.....

- Wide selection of integrated circuits and components
- Quality prototype and test equipment
- Computer kits and accessories

Additional items that Jameco offers:

- Tools
- Cables
- Connectors
- Data Books
- Motherboards
- Memory
- Math Coprocessors
- Computer Accessories
- Power Protection Equipment
- *Much, much more!*

Let us show you what we have to offer; call or write for the latest Jameco catalog!

\$50.00 Minimum Order

Data Sheets - 50¢ each

For a FREE 90-Page catalog send \$2.00 to cover First Class Postage and Handling
 © 1991 Jameco Electronics 7/91

CA Residents Add

6.00%, 6.50% or 7.00% Sales Tax
 Shipping, handling and insurance are additional.
 (Costs may vary according to weight and shipping method)
 Terms: Prices subject to change without notice.
 Items subject to availability and prior sale.
 Complete list of terms/warranties is available upon request.
 IBM is a registered trademark of International Business Machines



Please refer to Mail Key 2 when ordering

Integrated Circuits

Part No.	1-9	10+	Part No.	1-9	10+
00	\$.29	\$.19	7472	\$1.95	\$1.75
02	.29	.19	7473	.45	.35
04	.29	.19	7474	.39	.29
05	.35	.25	7475	.49	.39
06	.39	.29	7476	.45	.35
07	.39	.29	7483	.69	.59
08	.35	.25	7486	.45	.35
10	.29	.19	7489	2.95	2.75
11	.35	.25	7490	.49	.39
14	.35	.25	7493	.45	.35
17	.35	.25	74116	1.19	1.09
20	.29	.19	74121	.49	.39
27	.35	.25	74123	.49	.39
30	.35	.25	74125	.49	.39
32	.39	.29	74151	.39	.29
38	.45	.35	74160	.59	.49
42	.49	.39	74161	.69	.59
45	.75	.65	74192	.79	.69
46	.89	.79	74193	.79	.69
47	.89	.79	74194	1.19	1.09

Dynamic RAMs

64-100	100ns, 64K x 1	\$1.95	41256-100	100ns, 256K x 1	\$2.29
64-120	120ns, 64K x 1	1.89	41256-120	120ns, 256K x 1	2.19
64-150	150ns, 64K x 1	1.75	41256-150	150ns, 256K x 1	1.99
256-60	60ns, 256K x 1	3.25	511000P-80	80ns, 1MB x 1	8.95
256-80	80ns, 256K x 1	2.75	511000P-10	100ns, 1MB x 1	8.49

• Call for a complete listing of IC's

Miscellaneous Components

Potentiometers

Values available (insert ohms into space marked "XX"):
 500Ω, 1K, 5K, 10K, 20K, 50K, 100K, 1MEG
43PXX 3/4 Watt, 15 Turn \$.99
63PXX 1/2 Watt, 1 Turn \$.89

Transistors And Diodes

PN2222..... \$.12 **1N4735**..... \$.25 **2N4401**..... \$.15
PN2907..... .12 **2N3904**..... .12 **1N4148**..... .07
1N4004..... .10 **1N751**..... .15 **2N3055**..... .69
2N2222A..... .25 **C106B1**..... .59 **1N270**..... .25

Switches

JMT123 SPDT, On-On (Toggle) \$1.25
206-8 SPST, 16-pin (DIP)..... \$1.09
MPC121 SPDT, On-Off-On (Toggle)..... \$1.19
MS102 SPST, Momentary (Push-Button)..... \$.39

D-Sub Connectors and Hoods

DB25P Male, 25-pin \$.65 **DB25H** Hood \$.39
DB25S Female, 25-pin..... \$.75

LEDs

XC209R T1, (Red) \$.14 **XC556R** T1 3/4, (Red) ... \$.12
XC556G T1 3/4, (Green) ... \$.16 **XC556Y** T1 3/4, (Yellow) ... \$.16

IC Sockets

Low Profile **Wire Wrap (Gold) Level #2**
8LP.....\$.11 **8WW**.....\$.49
14LP..... .12 **14WW**..... .69
16LP..... .13 **16WW**..... .79
24LP..... .19 **24WW**..... 1.15
28LP..... .22 **28WW**..... 1.39
40LP..... .28 **40WW**..... 1.89

Soldertail Standard & Header Plug Sockets Also Available

Customer Service • Technical Assistance • Credit Department • All Other Inquiries • (415) 592-8097 • 7AM - 4PM P.S.T.

CIRCLE 114 ON FREE INFORMATION CARD

JULY 1991

ADVERTISING INDEX

RADIO-ELECTRONICS does not assume any responsibility for errors that may appear in the index below.

Free Information Number	Page	185	SCO Electronics	16	
108	AMC Sales	46	180	Sencore	CV4
181	Ace Communications	18	—	Star Circuits	28
75	Ace Products	21	92	Tektronix	3
107	All Electronics	91	123	Test Probes	46
—	Amazing Concepts	87, 94	—	The SPEC-COM Journal	10
84	Appliance Service	21	188	Unicorn	84
98	Beckman Industrial	9	186	U.S. Cable	16
109	C & S Sales	17	187	Viejo Publications	46
—	CIE	5, 25	179	WPT Publications	76
—	Cable Ready Company	89	—	Wholesale Cable	88
189	Cable Warehouse	75	184	Worldwide Cable	90
—	Command Productions	9			
58	Cook's Institute	16			
—	Damark International	11			
176	Datak Corporation	29			
127	Deco Industries	21			
—	Digital Engineering	88			
177	EasyTech	90			
178	Electronic Goldmine	94			
—	Electronics Book Club	7			
—	Electronics Engineer B.C.	80			
121	Fluke Manufacturing	CV2			
183	General Technics	21			
—	Global Cable Network	85			
—	Grantham College	75			
86	Heathkit	73			
—	ISCET	10			
114	Jameco	92, 93			
115	Jensen Tools	21			
87	MCM Electronics	87			
53	MD Electronics	89			
93	Mark V. Electronics	85			
61	Microprocessors Unltd.	79			
117	Mouser	11			
—	NPEC	27			
—	NRI Schools	12			
56	Parts Express	88			
—	Perfect Cable	86			
78	Radio Shack	30			
—	RE Video Offer	CV3			

ADVERTISING SALES OFFICE

Gernsback Publications, Inc.
 500-B Bi-County Blvd.
 Farmingdale, NY 11735
 1-(516) 293-3000
 President: **Larry Steckler**
Christina Estrada
 assistant to the President

For Advertising ONLY
 516-293-3000
Fax 1-516-293-3115
Larry Steckler
 publisher
Arline Fishman
 advertising director
Denise Haven
 advertising assistant
Kelly McQuade
 credit manager

Subscriber Customer Service
 1-800-288-0652
Order Entry for New Subscribers
 1-800-999-7139
 7:00 AM - 6:00 PM M-F MST

SALES OFFICES

EAST/SOUTHEAST
Stanley Levitan, Eastern Sales Manager
 Radio-Electronics
 259-23 57th Avenue
 Little Neck, NY 11362
 1-718-428-6037, 1-516-293-3000
 Fax 1-718-225-8594

MIDWEST/Texas/Arkansas/Okla.
Ralph Bergen, Midwest Sales Manager
 Radio-Electronics
 540 Frontage Road—Suite 339
 Northfield, IL 60093
 1-708-446-1444
 Fax 1-708-446-8451

PACIFIC COAST/Mountain States
Marvin Green, Pacific Sales Manager
 Radio-Electronics
 5430 Van Nuys Blvd. Suite 316
 Van Nuys, CA 91401
 1-818-986-2001
 Fax 1-818-986-2009

RE Shopper
Joe Shere, National Representative
 P.O. Box 169
 Idyllwild, CA 92349
 1-714-659-9743
 Fax 1-714-659-2469

3 FOR 1 SPECIAL

ON SUB-MINIATURE VOICE FM TRANSMITTERS. KITS CONTAIN PC BOARDS



***FMX-1 LONG RANGE (3 MI) ULTRA SENSITIVE FM VOICE XMTR** with fine tune, range control plus.....\$34.50



***TELX-1 TELEPHONE FM XMTR (3 MI)** automatically operates when phone is used. Crystal clear clarity with fine tune and range control. Non detectable.....\$34.50



***ATR-1 AUTOMATIC TELEPHONE RECORDING DEVICE** tapes telephone conversation all automatically.....\$19.50

ALL THREE OF ABOVE FOR.....\$69.50

CALL OR SEND VISA, MASTER CHARGE, MONEY ORDER, ETC. TO **AMAZING CONCEPTS**, BOX 716, AMHERST, NH 03031. (603) 673-4730.

THE ELECTRONIC GOLDMINE



The Electronic Goldmine has one of the greatest selections of unique electronic kits available in the world! We have over 130 kits and over 1,400 unique, bargain priced, components in our catalog!

FREE CATALOG
 With OVER 1400 DIFFERENT ITEMS INCLUDING 135 KITS! REQUEST YOUR COPY TODAY!



ITT MOUSE
 Precision mouse made for the ITT XTRA personal computer. Shipped complete with cables, box containing circuit board, mouse, software diskette and manual.
 G516 **\$5.00**

INFRARED DETECTOR KIT



Great for testing and verification of infrared output. Uses sensitive sensor and electronic circuitry to respond to all types of infrared TV, VCR, etc. remote controllers and LEDs producing sound and lighting a bright red LED. 9V battery (not included). Size of board: 2.5" x 1.4". Complete with all parts, PC board and instructions.
 C6441 **\$5.95**

ULTRASONIC PEST REPELLER KIT



According to research, low intensity ultrasonic sound waves repel insects and small rodents. The output of this kit is obnoxious to the pest, but is above the hearing range of humans, dogs, cats, and birds. 9V battery (not included). Size of board: 2.5" x 2". Complete with all parts, PC board and instructions.
 C6350 **\$9.00**

4KV TRIGGER COIL



Use with any strobe tube that needs a 3 lead 4KV trigger.
 N1700 **\$1.25 EA.**
 100 for **\$80.00**

INVERTER TRANSFORMER

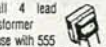

Small 4 lead transformer for use with 555 IC to convert 12VDC to 250V for strobe/fluorescent tubes with schematic.
 N1703 **\$2.00 EA.**
 10 for **\$18.00**

STROBE TUBE & SCHEMATIC

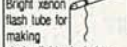

Bright xenon flash tube for making strobe light. Includes schematic showing this tube and trigger coil shown at left. Size of tube: 1.5".
 G936 **\$1.39**

ULTRAVIOLET SENSOR SUN EXPOSURE METER



Small electronic device detects UV energy from the sun and sounds a signal when you've had enough exposure. Has 2 dials for skin type and sun screen rating (SPF). Uses IC circuitry and special UV sensor. Assembled and ready to use, this new surplus item is now available at a fraction of the original cost. (Requires 9V battery, not included.) **G934 \$8.95**

MINIMUM ORDER: \$10.00 plus \$3.00 shipping and handling.

We accept MC, Visa and Money Orders.
 SEND ORDERS TO: The Electronic Goldmine
 P.O. Box 5408 Scottsdale, AZ 85261

PHONE ORDERS (602) 451-7454 FAX ORDERS (602) 451-9495

Countersurveillance

Never before has so much professional information on the art of detecting and eliminating electronic snooping devices—and how to defend against experienced information thieves—been placed in one VHS video. If you are a Fortune 500 CEO, an executive in any hi-tech industry, or a novice seeking entry into an honorable, rewarding field of work in countersurveillance, you must view this video presentation again and again.

Wake up! You may be the victim of stolen words—precious ideas that would have made you very wealthy! Yes, professionals, even rank amateurs, may be listening to your most private conversations.

Wake up! If you are not the victim, then you are surrounded by countless victims who need your help if you know how to discover telephone taps, locate bugs, or “sweep” a room clean.

There is a thriving professional service steeped in high-tech techniques that you can become a part of! But first, you must know and understand Countersurveillance Technology. Your very first insight into this highly rewarding field is made possible by a video VHS presentation that you cannot view on broadcast television, satellite, or cable. It presents an informative program prepared by professionals in the field who know their industry, its techniques, kinks and loopholes. Men who can tell you more in 45 minutes in a straightforward, exclusive talk than was ever attempted before.

Foiling Information Thieves

Discover the targets professional snoopers seek out! The prey are stock brokers, arbitrage firms, manufacturers, high-tech companies, any competitive industry, or even small businesses in the same community. The valuable information they filch may be marketing strategies, customer lists, product formulas, manufacturing techniques, even advertising plans. Information thieves eavesdrop on court decisions, bidding information, financial data. The list is unlimited in the mind of man—especially if he is a thief!

You know that the Russians secretly installed countless microphones in the concrete work of the American Embassy building in Moscow. They converted



1-800-522-6260

**HAVE YOUR
VISA or MC CARD
AVAILABLE**

what was to be an embassy and private residence into the most sophisticated recording studio the world had ever known. The building had to be torn down in order to remove all the bugs.

Stolen Information

The open taps from where the information pours out may be from FAX's, computer communications, telephone calls, and everyday business meetings and lunchtime encounters. Businessmen need counselling on how to eliminate this information drain. Basic telephone use coupled with the user's understanding that someone may be listening or recording vital data and information greatly reduces the opportunity for others to purloin meaningful information.

RADIO-ELECTRONICS VIDEO OFFER

500-B Bi-County Blvd.
Farmingdale, NY 11735

Please rush my copy of the Countersurveillance Techniques Video VHS Cassette for \$49.95 plus \$4.00 for postage and handling.

No. of Cassettes ordered _____
Amount of payment \$ _____

Bill my VISA MasterCard

Card No. _____

Expire Date ____ / ____

Signature _____

Name _____

Address _____

City _____ State _____ ZIP _____

All payments in U.S.A. funds. Canadians add \$4.00 per VHS cassette. No foreign orders. New York State residents add applicable sales tax.

The professional discussions seen on the TV screen in your home reveals how to detect and disable wiretaps, midget radio-frequency transmitters, and other bugs, plus when to use disinformation to confuse the unwanted listener, and the technique of voice scrambling telephone communications. In fact, do you know how to look for a bug, where to look for a bug, and what to do when you find it?

Bugs of a very small size are easy to build and they can be placed quickly in a matter of seconds, in any object or room. Today you may have used a telephone handset that was bugged. It probably contained three bugs. One was a phony bug to fool you into believing you found a bug and secured the telephone. The second bug placates the investigator when he finds the real thing! And the third bug is found only by the professional, who continued to search just in case there were more bugs.

The professional is not without his tools. Special equipment has been designed so that the professional can sweep a room so that he can detect voice-activated (VOX) and remote-activated bugs. Some of this equipment can be operated by novices, others require a trained countersurveillance professional.

The professionals viewed on your television screen reveal information on the latest technological advances like laser-beam snoopers that are installed hundreds of feet away from the room they snoop on. The professionals disclose that computers yield information too easily.

This advertisement was not written by a countersurveillance professional, but by a beginner whose only experience came from viewing the video tape in the privacy of his home. After you review the video carefully and understand its contents, you have taken the first important step in either acquiring professional help with your surveillance problems, or you may very well consider a career as a countersurveillance professional.

The Dollars You Save

To obtain the information contained in the video VHS cassette, you would attend a professional seminar costing \$350-750 and possibly pay hundreds of dollars more if you had to travel to a distant city to attend. Now, for only \$49.95 (plus \$4.00 P&H) you can view *Countersurveillance Techniques* at home and take refresher views often. To obtain your copy, complete the coupon below or call toll free.

Isolate These And Other Major Components In All TVs And VCRs— Guaranteed Or Your Money Back!

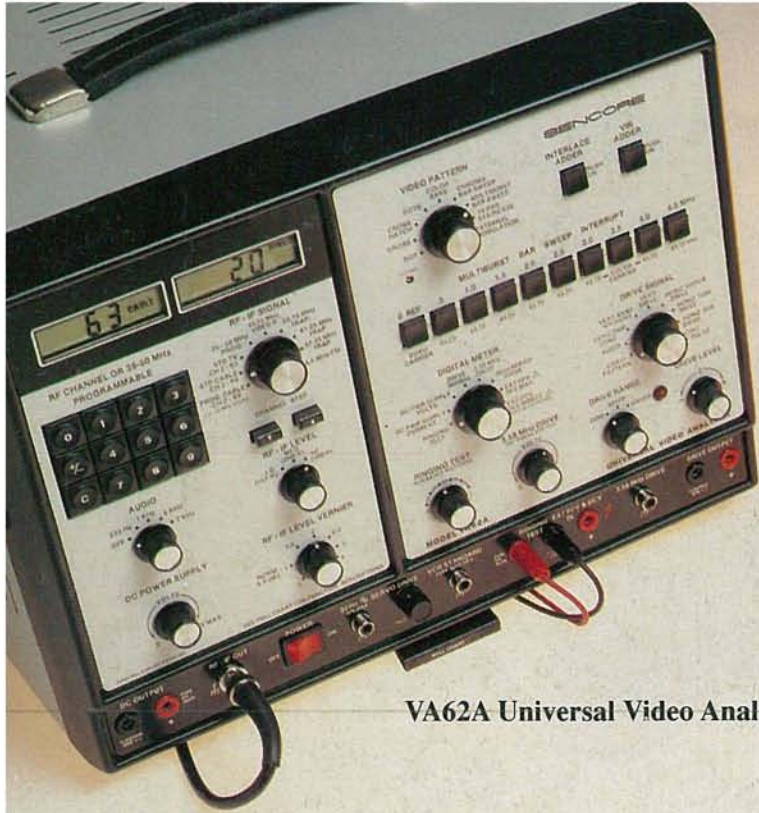

VA62A Universal Video Analyzer

Plus, Cut Your Video Troubleshooting Time By 54%* With The Patented VA62A Universal Video Analyzer!

Identify tuner problems with the only integrated all-channel, VHF, UHF, and cable RF generator. Standard TV, standard cable (2-99), and exclusive programmable cable channels eliminate the question "Is it the TV or is it the cable?"

Pinpoint IF troubles with modulated troubleshooting signals and exclusive programmable IF generator. How do you presently identify if the suspected defect is in the AGC, IF/Detector IC, or caused by the tuner? Wouldn't you like to know exactly where the defect is before you order the part or pull the tuner. With the VA62A you will!

Exclusive video patterns completely performance test TVs, VCRs, and monitors — without removing the cover. Is there a picture, is it locked in, is the bandwidth correct, is the brightness and contrast correct, and is the color tint and saturation correct? You'll know in less than 60 seconds using the VA62A's exclusive video patterns.

Find defective stages, without disconnecting parts, with exclusive phase-locked drive signals. "Swamp out" the suspect signal and replace it with a known-good signal. You'll isolate the problem to a bad stage in minutes, guaranteed.

Test yokes and flybacks with the patented "Ringer". Most shops are forced to substitute yokes and flybacks instead of

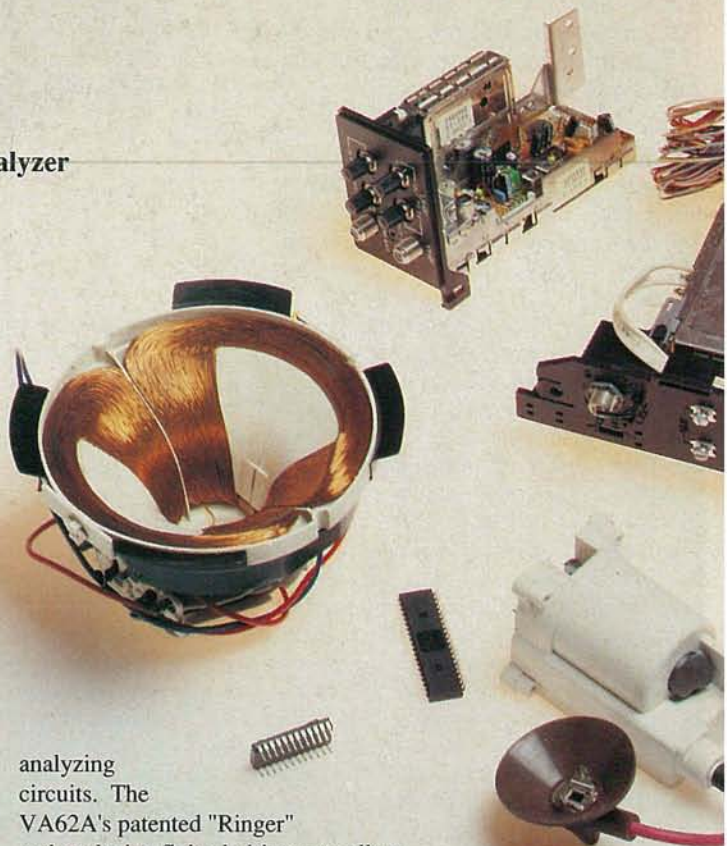

analyzing circuits. The VA62A's patented "Ringer" and exclusive flyback drive tests allow you to completely analyze all yokes, flybacks, and IHVTs before you order a new one.

Measure signal levels with a fully autoranged PPV and DCV digital meter. The VA62A's built-in meter shows when you are driving into a shorted circuit and prevents you from overdriving critical stages. Plus, measure bias voltages and signal levels throughout the entire TV and VCR.

It's obsolete proof: update for new technology with exclusive phase-locked accessories. We'll provide new companion units as the manufacturers announce new formats, test patterns, etc. This makes your VA62A a protected investment.

* Based on a nationwide survey of users who reported an average time savings of 54% compared to their previous test equipment.

For More Details Call 1-800-SENCORE ext. 612
(736-2673)

CIRCLE 180 ON FREE INFORMATION CARD